



DECORATIVE

23

Decorative



LIGHTING  
COLLECTION  
2023

Decorative

# LINEA LIGHT GROUP

Dalla nascita, nel 1985, ad oggi Linea Light Group è cresciuto fino a diventare ed essere riconosciuto come uno tra i maggiori player per l'illuminazione tecnica e decorativa. Queste due anime convivono e si alimentano a vicenda, grazie alla costante e continua ricerca formale e tecnologica del gruppo.

Con la recente acquisizione dello storico brand Stilnovo, celebre per i suoi prodotti innovativi e sperimentali, si arricchisce l'offerta decorativa di Linea Light Group. Da Stilnovo abbiamo ereditato oggetti luminosi disegnati da Ettore Sottsass e De Pas D'urbino Lomazzi passando per Joe Colombo, a queste icone abbiamo affiancato nuove lampade sviluppate interamente in azienda. L'acquisizione completa la collezione Decòrative composta da prodotti dalla grande personalità e dalla forte presenza scenica.

Contemporaneamente Linea Light Group mantiene la sua presenza di leadership nell'illuminazione professionale con il brand i-LèD, riconosciuto come uno tra i maggiori innovatori in ambito LED. Dal 2019 siamo posizionati nel segmento urban & industrial lighting con prodotti dedicati, rafforzando la nostra presenza nel mercato dell'illuminazione tecnica con prodotti efficienti e innovativi.

La completezza dei nostri cataloghi ci consente di essere presenti e attivi, su canali di vendita diversificati, permettendoci di fornire in maniera ottimale e veloce ogni nostro cliente. Precisione, rapidità e affidabilità sono i caratteri che da sempre definiscono Linea Light Group.

From the time of its establishment in 1985 to the present, Linea Light Group has grown to the point of becoming and being known as one of the major players in technical and decorative lighting. These two spirits co-exist and fuel one another thanks to the group's constant and continuous technological research.

With the recent acquisition of the historic Stilnovo brand, famous for its innovative and experimental products, Linea Light Group's decorative range is enriched. From Stilnovo, we inherited lighting items designed by Ettore Sottsass and De Pas D'urbino Lomazzi, as well as Joe Colombo, and we brought new lights alongside these icons, developed entirely in-house. The acquisition completes the Decòrative collection made up of products with great personality and a strong dramatic presence.

Linea Light Group simultaneously maintains its presence as a leader in professional lighting with the i-LèD brand, acknowledged as one of the major innovators in the LED area. From 2019, we have been in the urban & industrial lighting segment with dedicated products, reinforcing our presence in the technical lighting market with efficient and innovative products.

The completeness of our catalogues allows us to be present and active on diversified sales channels, so we are able to supply all our customers optimally and quickly. Precision, speed and reliability are the characteristics that have always defined Linea Light Group.



Lavorazione dell'estruso in una delle tre linee di taglio presenti nel sito produttivo di Vazzola (TV Italia).

Extrudate processing in one of the three cutting lines at the Vazzola (TV Italy) production site.





# AZIENDA INTERNAZIONALE

Tre hub produttivi per garantire un servizio globale su misura a disposizione del professionista della luce.

Linea Light Group è un insieme unico di realtà specializzate nei diversi ambiti che compongono l'universo dell'illuminazione, indipendenti e coordinate allo stesso tempo. Una formula che consente di creare soluzioni complete e originali, in qualsiasi contesto, dai sistemi integrati per grandi edifici residenziali o pubblici, all'illuminazione per esterni o in immersione, dagli ambienti domestici agli spazi commerciali, industriali, istituzionali e collettivi.

Linea Light Group si è distinta per un approccio al mercato attento alle peculiarità e alle esigenze dei partner locali in un'ottica "Think Global, Act Local", puntando alla connessione delle aree e al servizio curato su distanze ridotte. Oggi Linea Light Group è un'azienda con una forte presenza internazionale, con una rete capillare sempre al fianco dei propri partner ovunque siano i loro progetti.



-  **Headquarter**
-  **Hub-Branches**
-  **Branches**

# INTERNATIONAL COMPANY

Three production hubs to guarantee tailored global service at the disposal of lighting professionals.

Linea Light Group is a unique group specialised in a diverse range of domains within the world of lighting. It is independent yet coordinated at the same time. Its formula allows for the creation of complete, unique solutions in any given context: from integrated systems for large residential or public buildings to outdoors or underwater lighting; from home environments to commercial, industrial, institutional or public spaces.

Linea Light Group stands out thanks to a market approach that is attentive to specific requirements and to the demands of local partners. Its "Think Global, Act Local" vision focusses on making connections between different areas and on managing services from a shorter distance. Today, Linea Light Group is a company with a strong international presence and an extensive network: wherever their projects may take them, their partners will be right by their side.





## LIGHT UP

### MULTI-LEVEL APPROACH

Per noi la parola ILLUMINARE ha un significato profondo, un'azione importante nella vita di tutti i giorni e che racchiude in sé molteplici significati e applicazioni: la nostra mission è quella di dare voce a tutte queste diversità. Per questo motivo il gruppo Linea Light trova espressione in differenti collezioni capaci di risolvere le soluzioni illuminotecniche ricercate dai nostri partners. A partire dal nostro brand **i-LèD** specializzato in soluzioni professionali e Industriali, come anche il brand **Decorative** con la sua collezione di prodotti decorativi moderni fino ad arrivare a **STILNOVO** i cui apparecchi senza tempo sono stati disegnati dai maestri del design del passato e del presente. E all'interno di ogni Brand troviamo ulteriori **livelli di specializzazione**, con prodotti che ci consentono di realizzare le facciate multimediali e appariscenti delle moderne architetture, ma capaci all'occorrenza di "nascondersi" in modo rispettoso all'interno di chiese, musei e tutti quegli ambienti storici che necessitano essere difesi da una luce spesso troppo invadente.

### MULTI-LEVEL APPROACH

For us, the word ILLUMINATE has a profound meaning. It has an important effect on our daily lives, one which encapsulates a whole host of meanings and applications: our mission is to lend a voice to all these differences. This is why Linea Light Group expresses itself in different collections capable of solving the lighting solutions sought by our partners. Starting with our **i-LèD** brand, specialising in professional and industrial products, as well as the **Decorative** brand with its modern, decorative collection, along with **STILNOVO** whose timeless products were designed by masters of past and present design. There are **additional levels of specialisation** within each brand, featuring products that allow us not only to light up the multimedia and striking facades of modern architecture but which are also capable of respectfully "hiding" inside churches, museums and all those historical settings that need to be protected from often overly intrusive light.

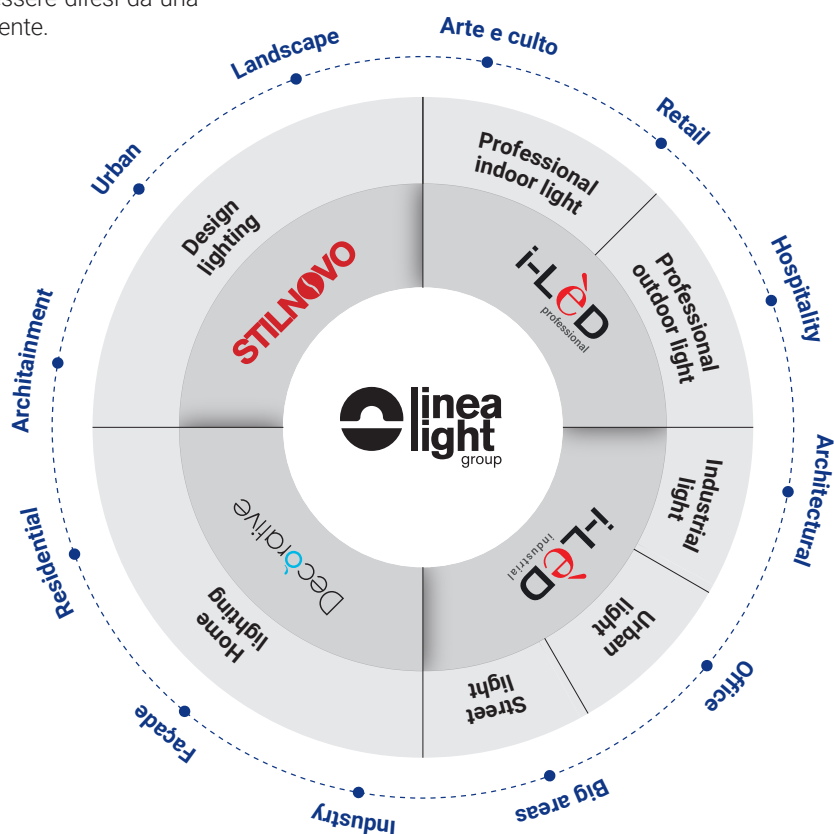





## NEW

### FUORI DAGLI SCHEMI

Il mondo dell'illuminazione vive di tecnologia e innovazione ma anche di un approccio statico e ripetitivo. Le aziende specializzate nei prodotti Decorativi puntano esclusivamente sulla forma e sul design, mentre quelle professionali sulla funzione e sulla performance. Linea Light applica invece un approccio "trasversale", un **NUOVO** modo di pensare al prodotto che lascia libertà di azione ed espressione alla creatività del nostro team di R&D. Esperti di microelettronica, ottica geometrica, scienza dei materiali, informatica digitale, ma anche prototipisti meccanici e tornitori specializzati dialogano quotidianamente con designer di moda, gestori di supermercati, dirigenti di grandi catene alberghiere ed ovviamente professionisti come architetti e lighting designers, riuscendo ad ideare prodotti innovativi per tecnologia e applicazione. Il nostro approccio sperimentale si traduce su diversi campi: nuove idee e strategie vengono applicate alla logistica, finanza, pianificazione, alla scelta dei macchinari e dei processi produttivi, fino ad arrivare alle modalità di vendita nel suo complesso.

**1** Tutti gli scarti di lavorazione vengono sottoposti ad una fase di pulitura con specifico disoleatore che separa olio e truciolo reimmettendo questi materiali nella filiera produttiva.

**2** Magazzino automatizzato composto da 21.000 cassette per lo stoccaggio di componenti e minuteria. Caratterizzato da un'alta efficienza energetica, l'autostore ottimizza resa e velocità delle operazioni di picking.

### OUTSIDE THE BOX

The world of lighting thrives not only on technology and innovation but also on a static and repetitive approach. Decor companies focus exclusively on the shape and design while professional companies focus on function and performance. Linea Light Group, however, takes an "across-the-board" approach, a **NEW** way of thinking about the product which leaves freedom of action and expression to the creativity of our R&D team. They are experts in micro-electronics, geometric optics, material science, digital information technology, as well as being mechanical prototype designers and specialised turners, interacting daily with fashion designers, supermarket managers, directors of major hotel chains and, obviously, professionals such as architects and lighting designers, succeeding in inventing innovative products in terms of technology and application. Our experimental approach is applied to different fields: new ideas and strategies are applied to logistics, finance, planning, to the choice of machinery and production processes, and even sales methods as a whole.

**1** All production waste is cleaned with a specific de-oiler which separates oil and chip, reintroducing these materials into the production supply chain.

**2** Automated warehouse consisting of 21,000 drawers for storing components and small parts. With high energy efficiency, the autostore optimises the throughput and speed of picking operations.

## IDEAS!

### CONCRETEZZA

Siamo persone abituate ad avere le **"mani in pasta"** e a **"fare prodotti"**. Siamo persone concrete ma nello stesso tempo cordiali e aperte, e ci piace invitare a casa nostra i professionisti, portandoli nella stanza che preferiamo: non certo il salotto di rappresentanza ma bensì la **"cucina"**! Mostrare la **"fabbrica"** è per noi motivo di profondo orgoglio, ma anche il modo migliore per consentire al nostro ospite di comprendere le numerose potenzialità della nostra azienda, mettendo a sua disposizione tutta la nostra conoscenza e tecnologia (oltre ai nostri tecnici migliori), per dare vita alle sue **IDEE PROGETTUALI**.

**3** Tornio manuale utilizzato per la realizzazione di prototipi e pezzi unici.





























### PRAGMATISM

We are the kind of people who like to get **"our hands dirty"** and **"make products"**. We are down-to-earth, yet friendly and open-minded individuals. We like inviting professionals into our home and taking them into our favourite room - not the reception room, but rather the **"kitchen"**! Showcasing the **"factory"** is a not only source of immense pride for us but also the best way for our guest to understand the many potentials of our company, putting all our knowledge and technology (as well as our best technicians) at their disposal to bring their **DESIGN IDEAS** to life.

**3** Manual lathe used to create prototypes and one-off pieces.

# INDOOR application index

## RECESSED





















<b>Birba_C</b>  22	<b>Bubble</b>  24 <b>NEW</b>	<b>Gypsum Coloring</b>  27	<b>Gypsum_R</b>  31	<b>Gypsum_Eye1</b>  31	<b>Gypsum_01</b>  33	<b>Gypsum_03</b>  33
<b>Gypsum_QD1</b>  34	<b>Gypsum_QC2</b>  34	<b>Gypsum_QRD</b>  35	<b>Gypsum_QD2</b>  35	<b>Gypsum_QC3</b>  36	<b>Gypsum_D1</b>  37	<b>Gypsum_D2</b>  37
<b>Gypsum_SR</b>  39	<b>Gypsum_SQ</b>  39	<b>Gypsum_WR3</b>  41	<b>Gypsum_WRX</b>  41	<b>Gypsum_WR1</b>  42	<b>Gypsum_WR2</b>  42	<b>Gypsum_WRQ</b>  43
<b>Gypsum_WF1</b>  44	<b>Gypsum_WF2</b>  44	<b>Gypsum_WF3</b>  45	<b>Gypsum_WF4</b>  45	<b>One to one_C</b>  46	<b>Outlook_C</b>  47	

## PENDANT LUMINAIRES

<b>Antigua_P</b>  50	<b>Antille_P</b>  51	<b>Aruba_P</b>  52	<b>Birba_P</b>  54	<b>Crew_1</b>  + Suspension KIT 59 <b>NEW</b>	<b>Crew_2</b>  + Suspension KIT 61 <b>NEW</b>	<b>Dublight_P</b>  62
<b>Halfpipe 2_P</b>  64 <b>NEW</b>	<b>Horizon_P</b>  66	<b>Miguel</b>  68 <b>NEW</b>	<b>Minion_P</b>  70	<b>Oh!_P</b>  72	<b>Oh! Smash_P</b>  76	<b>Ohps_P</b>  77

# INDOOR application index

## PENDANT LUMINAIRES

<p>Outlook_P</p>  <p>78</p>	<p>Perla_P9</p>  <p>80 <b>NEW</b></p>	<p>Perla_P12</p>  <p>80 <b>NEW</b></p>	<p>Poe_P1</p>  <p>85 <b>NEW</b></p>	<p>Poe_P3</p>  <p>87 <b>NEW</b></p>	<p>Poe_Plus</p>  <p>87 <b>NEW</b></p>	<p>Polo_P</p>  <p>88</p>
<p>Rose_P</p>  <p>89</p>	<p>Satori_P</p>  <p>90 <b>NEW</b></p>	<p>Sinfonia Puccini</p>  <p>95</p>	<p>Sinfonia Rossini_P</p>  <p>97</p>	<p>Sinfonia Verdi</p>  <p>97</p>	<p>Sinfonia Vivaldi_P1</p>  <p>97</p>	<p>Sinfonia Vivaldi_P3</p>  <p>97</p>
<p>Squash_P</p>  <p>98</p>	<p>Straight_P1</p>  <p>103</p>	<p>Straight_P3</p>  <p>103</p>	<p>TU-O</p>  <p>104</p>	<p>TU-V</p>  <p>106</p>	<p>Yo-yo_P</p>  <p>110 <b>NEW</b></p>	<p>Zig zag_P</p>  <p>112</p>

## CEILING & WALL

<p>Alba</p>  <p>116 <b>NEW</b></p>	<p>Antigua_S</p>  <p>118</p>	<p>Antille_S</p>  <p>120</p>	<p>Aruba_S</p>  <p>122</p>	<p>Bart</p>  <p>123</p>	<p>Beebo_S</p>  <p>125</p>	<p>Beebo_W</p>  <p>127</p>
<p>Birba_S</p>  <p>129</p>	<p>Birba_W</p>  <p>131</p>	<p>Box_SR</p>  <p>133</p>	<p>Box_SQ</p>  <p>135</p>	<p>Box_SB</p>  <p>136</p>	<p>Box_W</p>  <p>138</p>	<p>Circular</p>  <p>144</p>
<p>Crew_1</p>  <p>147</p>	<p>Crew_2</p>  <p>149</p>	<p>Crumb</p>  <p>150</p>	<p>Curvè</p>  <p>152</p>	<p>Dublight_SQ</p>  <p>155</p>	<p>Dublight_W</p>  <p>157</p>	<p>Duck_S</p>  <p>159 <b>NEW</b></p>



















# INDOOR application index

## CEILING & WALL

<b>Duck_W</b>  161 <b>NEW</b>	<b>Eta</b>  162 <b>NEW</b>	<b>Gemini_S</b>  165 <b>NEW</b>	<b>Gemini_W1</b>  167 <b>NEW</b>	<b>Gemini_W2</b>  167 <b>NEW</b>	<b>Goose</b>  168 <b>NEW</b>	<b>Gypsum_W</b>  170
<b>Halfpipe 2_W</b>  172 <b>NEW</b>	<b>Horizon_S</b>  174	<b>Igloo_S</b>  177	<b>Igloo_W</b>  179	<b>Kioo</b>  180	<b>Metal</b>  182	<b>Mille_W</b>  185
<b>Mille_SB</b>  187	<b>Minion_S</b>  188	<b>Oh!_S</b>  190	<b>Oh! Smash_S</b>  192	<b>Ohps_S</b>  193	<b>One to one_S</b>  194	<b>Outlook_S</b>  195
<b>Poe_W</b>  196 <b>NEW</b>	<b>Polo_S</b>  198	<b>Regolo</b>  200	<b>Reiki</b>  202	<b>Rose_S</b>  204	<b>Satori_W</b>  207 <b>NEW</b>	<b>Satori_S</b>  209 <b>NEW</b>
<b>Sinfonia Rossini_S</b>  211	<b>Sinfonia Rossini_W</b>  211	<b>Skinny</b>  212	<b>Snake_W1</b>  215	<b>Snake_W2</b>  217	<b>Snake_W3</b>  217	<b>Squash_S</b>  218
<b>Straight_W</b>  219	<b>Tara_R</b>  221 <b>NEW</b>	<b>Tara_Q</b>  221 <b>NEW</b>	<b>Tara_B</b>  225 <b>NEW</b>	<b>Tara Maxi</b>  227 <b>NEW</b>	<b>Tara Mega</b>  227 <b>NEW</b>	<b>Triad 2.0</b>  229
<b>Triad_S</b>  231	<b>Triad_W</b>  231	<b>TU-Top</b>  232	<b>Yo-yo_W</b>  234 <b>NEW</b>	<b>Zig zag_S</b>  237	<b>Zig zag_W</b>  237	

# INDOOR application index

## FLOOR & TABLE





















Antigua_FL  240	Birba_TAB  243	Birba_FL  243	Camping  244 <b>NEW</b>	Dama  246	Dubcolor  250 <b>NEW</b>	Dublight_FL  253
Dublight_TAB  253	Gemini_TAB  254 <b>NEW</b>	Halfpipe 2_FL  256 <b>NEW</b>	Joshua  260	Oh!_FL  262	Oh! Smash_FL  264	Ohps_FL  265
Poe_FL  266 <b>NEW</b>	Sinfonia Rossini_TAB  268	Squash_TAB  271	Squash_FL  271			

## SYSTEMS

Igloo_S  274	Polo_S  278	Sinfonia System Puccini  287	Sinfonia System Rossini_S  288	Sinfonia System Rossini_P  288	Sinfonia System Verdi  288	Sinfonia System Vivaldi  288
---	--	---	---	---	---	---

# INDOOR application index

## CABLES

<p>Andromeda-C</p>  <p>294 <b>NEW</b></p>	<p>Beebo-C30</p>  <p>295</p>	<p>Circular-C</p>  <p>296 <b>NEW</b></p>	<p>Eta-C</p>  <p>299 <b>NEW</b></p>	<p>Eta-C30</p>  <p>299 <b>NEW</b></p>	<p>Iota-C</p>  <p>301 <b>NEW</b></p>	<p>Iota-C30_1</p>  <p>303 <b>NEW</b></p>
<p>Iota-C30_2</p>  <p>303 <b>NEW</b></p>	<p>Iota-C30_3</p>  <p>303 <b>NEW</b></p>	<p>Matrix-C30</p>  <p>304</p>	<p>Outlook-C</p>  <p>305</p>	<p>Oh!-C1</p>  <p>307</p>	<p>Oh!-C2</p>  <p>307</p>	<p>Oh!-C30</p>  <p>307</p>
<p>Polo-C</p>  <p>309</p>	<p>Trix-C</p>  <p>311 <b>NEW</b></p>	<p>Trix-C30</p>  <p>311 <b>NEW</b></p>	<p>TU-V-C</p>  <p>312</p>	<p>Vega-C30_1</p>  <p>315 <b>NEW</b></p>	<p>Vega-C30_2</p>  <p>315 <b>NEW</b></p>	<p>Cables Accessories</p>  <p>316 <b>NEW</b></p>

# OUTDOOR application index

## PENDANT LUMINAIRES



## CEILING & WALL

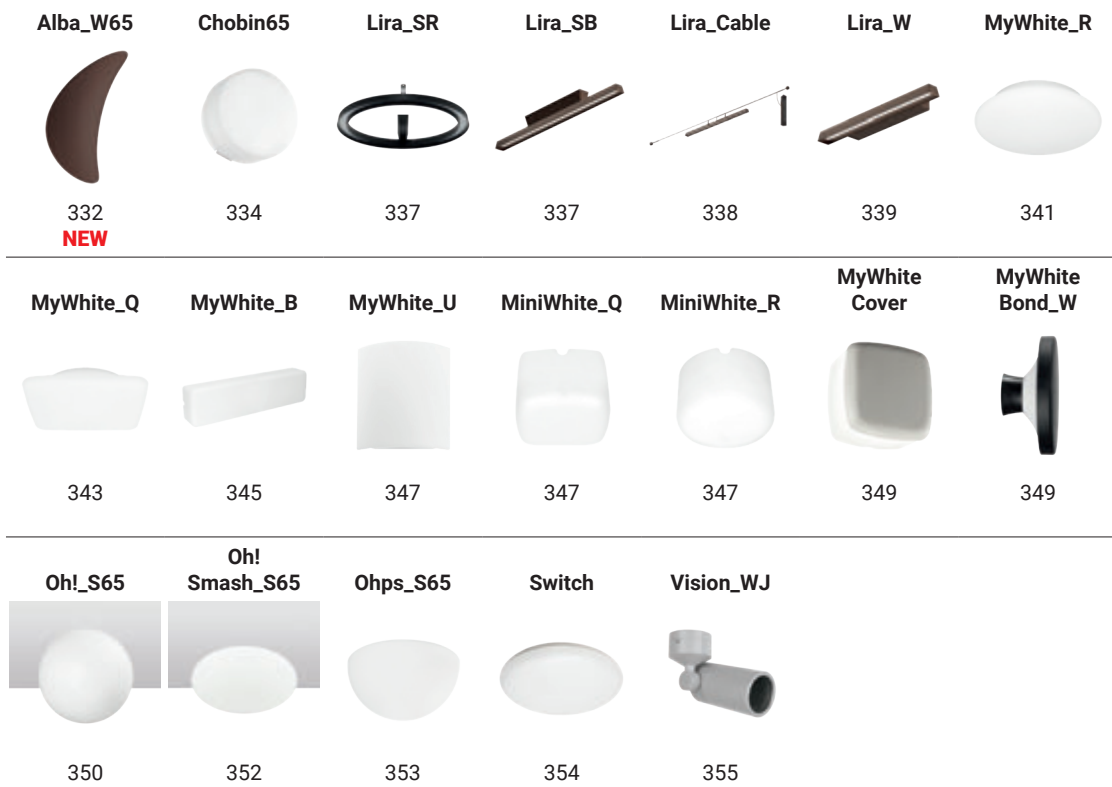

## FLOOR

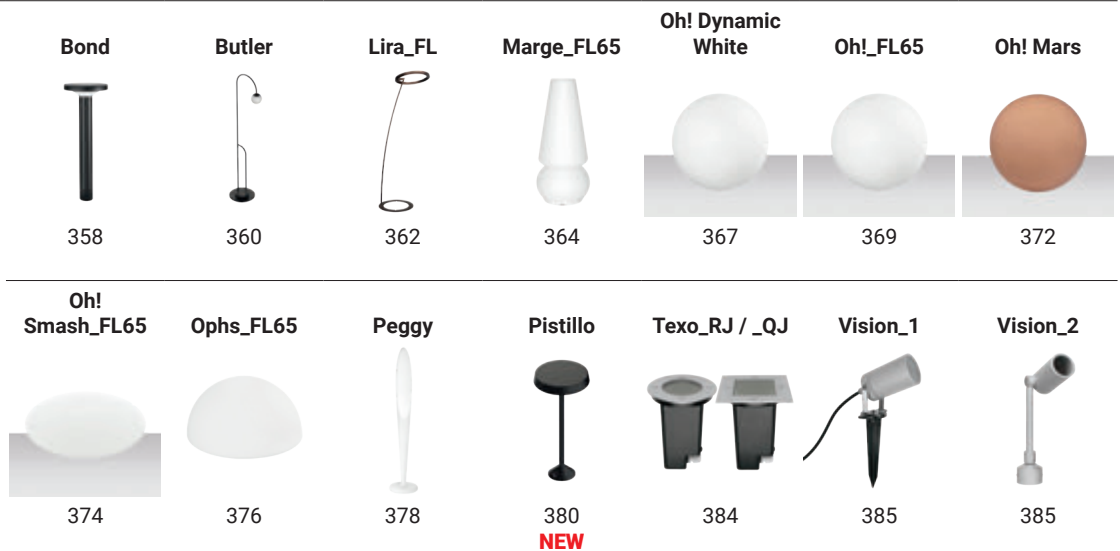

# INDOOR family index

## ALBA

- White
- Black

Alba



116

NEW

## ANDROMEDA

- White
- Black
- Grey

Andromeda-C



294

NEW

## ANTIGUA

- White

Antigua\_P



50

Antigua\_S



118

Antigua\_FL



240

## ANTILLE

- White
- Chrome
- Copper
- Gold

Antille\_P



51

Antille\_S



120

## ARUBA

- White
- Chrome
- Copper
- Gold

Aruba\_P



52

Aruba\_S



122

## BART

- White
- Black

Bart



123

## BEEBO

- White
- Black
- Oak Wood
- Grey

Beebo\_S



125

Beebo\_W



127

Beebo-C30

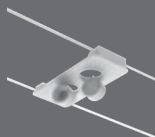

295







# INDOOR family index

## BIRBA

-  White
-  Polished Brass
-  Polished Aluminium



## BOX

-  White
-  Black
-  Concrete
-  Brushed Copper
-  Brushed Brass





## BUBBLE

-  White
-  Black



NEW



## CAMPING

-  White
-  Black
-  Dark Brown



NEW

## CIRCULAR

-  White
-  White / Chrome
-  Black (only Circular-C)

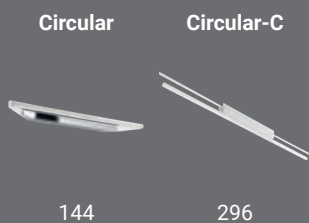

NEW

## CREW

-  White
-  Dark Grey
-  Burnished



NEW

-  White
-  White / Painted Copper
-  Black / White
-  Black / Painted Gold
-  Sablè / Tiffany Green



NEW

# INDOOR family index

## CRUMB

- White / Transparent
- Black / Smoked

Crumb



150

## CURVÈ

- White
- Dark Brown
- Concrete

Curvè



152

## DAMA

- White
- Black
- Dark Brown
- Strawberry Red
- Pastel Blue
- Pastel Green

Dama

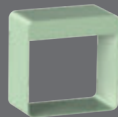

246

## DUBCOLOR

- White
- Black
- Dark Brown
- Ruby Red
- Pastel Blue
- Pastel Green

Dubcolor

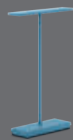

250

NEW

## DUBLIGHT

- White

Dublight\_P



62

Dublight\_SQ



155

Dublight\_W

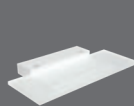

157

Dublight\_FL



253

Dublight\_TAB



253

## DUCK

- White / Chrome
- Black / Gold

Duck\_S



159

Duck\_W



161

NEW

## ETA

- White
- Black

Eta



162

Eta-C



299

Eta-C30







299

NEW

# INDOOR family index





## GEMINI

-  Nero Greco
-  Statuarietto
-  Bronze Mirrored Glass

<b>Gemini_S</b>	<b>Gemini_W1</b>	<b>Gemini_W2</b>	<b>Gemini_TAB</b>
			
165	167	167	254

NEW

## GOOSE

-  White / Brushed gold
-  Black / Brushed nickel
-  White / Brushed nickel
-  Black / Brushed gold







<b>Goose</b>







168

NEW

## GYPSUM

-  White

<b>Gypsum Coloring</b>	<b>Gypsum_R</b>	<b>Gypsum_Eye1</b>	<b>Gypsum_01</b>	<b>Gypsum_03</b>	<b>Gypsum_QD1</b>	<b>Gypsum_QC2</b>
						
27	31	31	33	33	34	34



<b>Gypsum_QRD</b>	<b>Gypsum_QD2</b>	<b>Gypsum_QC3</b>	<b>Gypsum_D1</b>	<b>Gypsum_D2</b>	<b>Gypsum_SR</b>	<b>Gypsum_SQ</b>
						
35	35	36	37	37	39	39

<b>Gypsum_WR3</b>	<b>Gypsum_WRX</b>	<b>Gypsum_WR1</b>	<b>Gypsum_WR2</b>	<b>Gypsum_WRQ</b>	<b>Gypsum_WF1</b>	<b>Gypsum_WF2</b>
						
41	41	42	42	43	44	44

<b>Gypsum_WF3</b>	<b>Gypsum_WF4</b>	<b>Gypsum_W</b>
		
45	45	170

## HALFPIPE 2

-  White
-  Black
-  Polished Aluminium

<b>Halfpipe 2_P</b>	<b>Halfpipe 2_W</b>	<b>Halfpipe 2_FL</b>
		
64	172	256

NEW

# INDOOR family index

## HORIZON

- White
- White / Gold
- White / Chrome

Horizon\_P



66

Horizon\_S



174

## IGLOO

- White
- Black
- Polished Aluminium

Igloo\_S



177

Igloo\_W



179

Igloo System



274

## IOTA

- White
- Black

Iota-C



301

Iota-C30\_1



303

Iota-C30\_2

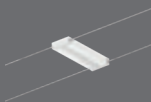

303

Iota-C30\_3

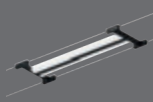

303

NEW

## JOSHUA

- White
- Black

Joshua



260

## KIOO

- White
- Anodised Aluminium

Kioo



180

## MATRIX

- White
- Grey

Matrix-C30



304

## METAL

- White
- Black

Metal



182

# INDOOR family index

NEW

## MIGUEL

- White
- Black
- Light grey
- Azure Blue
- Opal Green
- Vermilion

Miguel



68

## MILLE

- White / Sandblasted Glass

Mille\_W



185

Mille\_SB



187

## MINION

- White
- Black

Minion\_P



70

Minion\_S



188

## OH!

- White

Oh!\_P



72

Oh!\_S



190

Oh!\_FL



262

Oh!-C1



307

Oh!-C2



307

Oh!-C30



307

## OH! SMASH

- White

Oh! Smash\_P



76

Oh! Smash\_S



192

Oh! Smash\_FL



264

## OHPS

- White

Ohps\_P



77

Ohps\_S



193

OhpsFL



265

## ONE TO ONE

- White

One to one\_C



46

One to one\_S



194

# INDOOR family index

## OUTLOOK

-  White
-  Grey







47

78

195

305

## PERLA

-  Brush. Black Nickel / White
-  Brush. Black Nickel / Black
-  Brushed Gold / White
-  Brushed Gold / Black

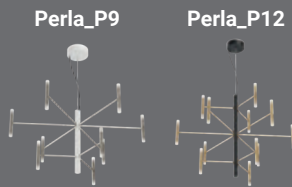

80

80

NEW

## POE

-  White
-  Black
-  Basalt Grey
-  Terracotta



85

87

87

196

266

NEW

## POLO

-  White

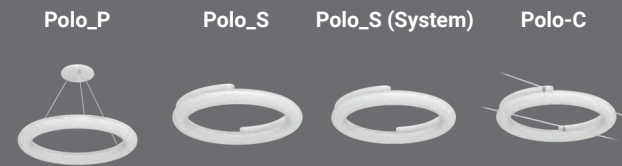



88

198

278

309

## REGOLO

-  White
-  Black
-  Anodised Aluminium



200

## REIKI

-  White
-  Dark Grey



202

## ROSE

-  White

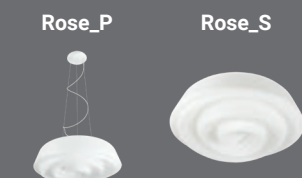

89

204

# INDOOR family index

## SATORI

-  White
-  Black

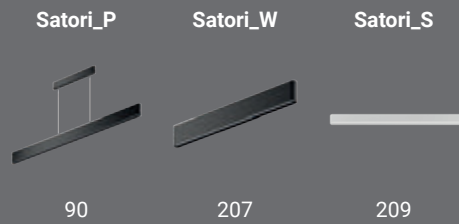



NEW

## SINFONIA

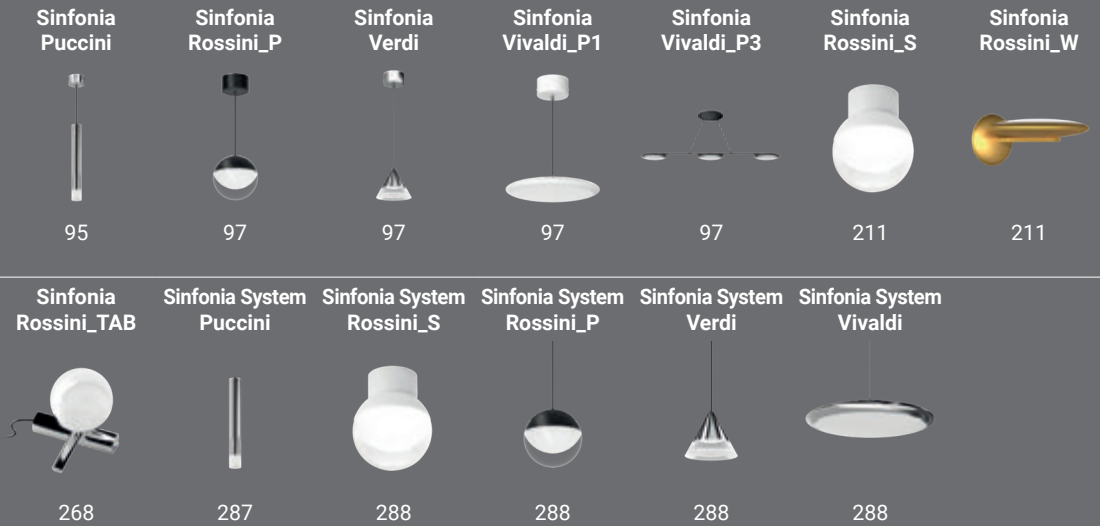
-  White
-  Black
-  Chrome
-  Brushed Gold



## SKINNY

-  White
-  Anodised Aluminium



## SNAKE

-  White
-  Black



## SQUASH

-  White

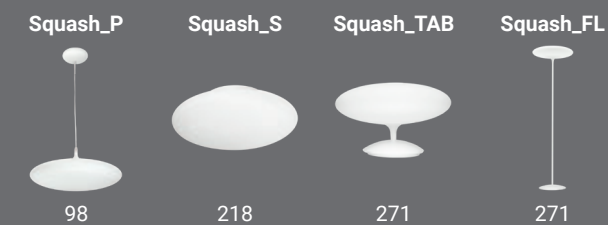

## STRAIGHT

-  White
-  Black
-  Chrome

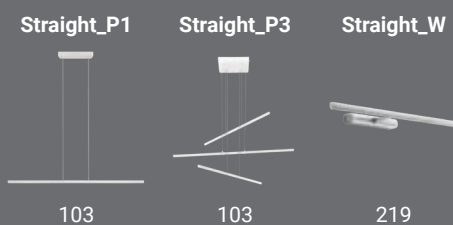

# INDOOR family index

## TARA

White  
Black

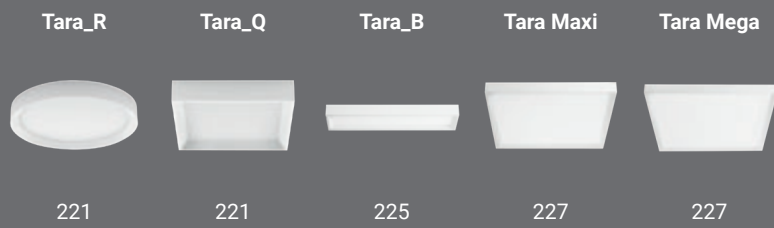

NEW

## TRIAD

White  
White / Wengè

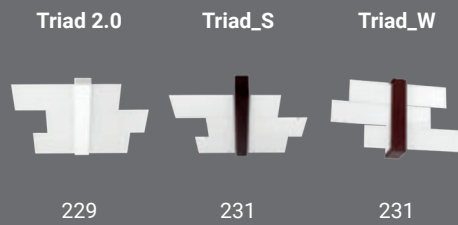

## TRIX

White  
Black  
Grey



NEW

## TU-O

White



## TU-TOP

White



## TU-V

White

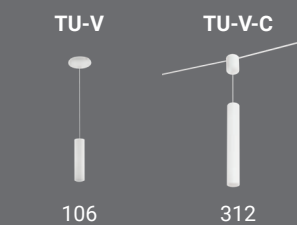

## VEGA

White  
Grey

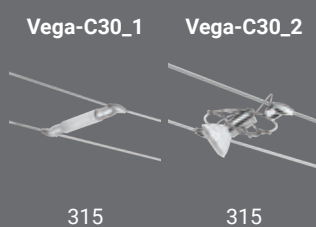

NEW



# INDOOR family index

## YO-YO

- White
- Black
- Grey
- Ruby Red

Yo-yo\_P



110

Yo-yo\_W



234

NEW

## ZIG ZAG

- White
- Black
- Black / White
- Anodised Aluminium

Zig zag\_P



112

Zig zag\_S



237

Zig zag\_W



237

# OUTDOOR family index

## ALBA

- Dark Brown
- Grey

Alba



332

NEW

## BOND

- Black

MyWhite  
Bond\_W



349

Bond



358

## BUTLER

- Black

Butler



360

# OUTDOOR family index

## CHOBIN65

White

Chobin65



334

## LIRA

Dark Brown  
Black

Lira\_PB

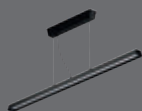

323

Lira\_PR



323

Lira\_SR



337

Lira\_SB

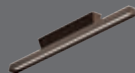

337

Lira\_Cable



338

Lira\_W

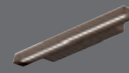

339

Lira\_FL



362

## MARGE

White

Marge\_FL65



364

## MYWHITE

White

MyWhite\_R



341

MyWhite\_Q



343

MyWhite\_B



345

MyWhite\_U



347

MiniWhite\_Q



347

MiniWhite\_R



347

MyWhite  
Cover

White  
Black



349

## OH!

White

Oh!\_P65



324

Oh!\_S65



350

Oh! Dynamic  
White



367

Oh!\_FL65



369

## OH! MARS

Lava

Oh! Mars



372

# OUTDOOR family index

## OH! SMASH

White

Oh!  
Smash\_P65



328

Oh!  
Smash\_S65



352

Oh!  
Smash\_FL65



374

## OHPS

White

Ohps\_S65



353

Ohps\_FL65



376

## PEGGY

White

Peggy



378

## PISTILLO

Dark Brown  
Black

Pistillo



380

NEW

## SWITCH

White

Switch



354

## TEXO

Stainless Steel

Texo\_RJ



384

Texo\_QJ



384

## VISION

Grey  
Dark Brown

Vision\_WJ



355

Vision\_1



385

Vision\_2



385





**RECESSED**

# Birba

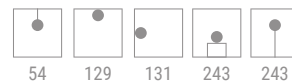

Corpo in ottone lucido, alluminio lucido o alluminio verniciato bianco raggrinzante.

Body in polished brass, polished or wrinkle effect white painted aluminium.





Birba\_C | 220-240 V | GU10 / E27



### Attacco E27 E27 fitting

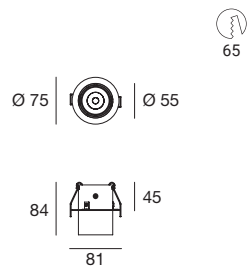

65



Product	Source
9451	GU10
9453	Max 7 W LED Bulb (not included)
9454	

### Attacco regolabile GU10 Adjustable GU10 fitting

Product	Source
9457	E27
9459	Max 22 W LED Bulb (not included)
9460	

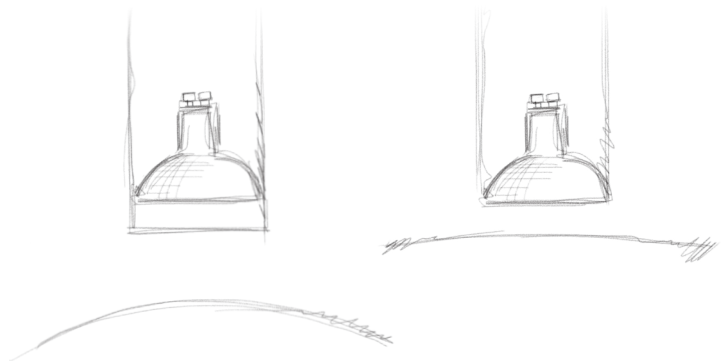

#### Finishes

White | Polished Brass | Polished Aluminium

Recessed

# Bubble

Corpo in gesso verniciabile. Sfera in alluminio verniciato bianco o nero raggrinzante.

Paintable plaster body. Sphere in white or black wrinkle effect painted aluminium.







**Bubble** | arrayLED 6 W DC 24 V

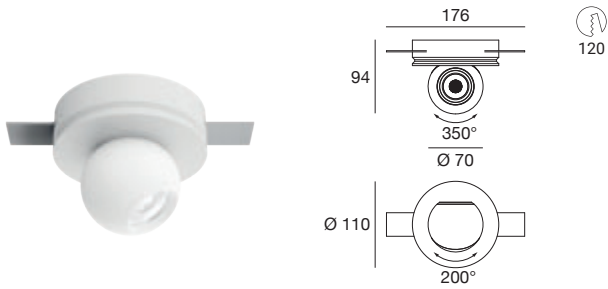

Product	Cct	Cri	lm S	lm D	Optics
White 9786	3000	90	733	677	Spot (15°)
Black 9787					
White 9788	3000	90	733	677	M.Flood (34°)
Black 9789					
White 9790	3000	90	733	677	W.Flood (62°)
Black 9791					

**Electronics Description**

<b>KIT0097</b>	DIMM DALI / 1-10 V / PUSH Driver (max. 10 art.)
<b>KIT0114</b>	ON/OFF Driver (max. 1 art.)

**Bubble** | arrayLED 9 W DC 24 V

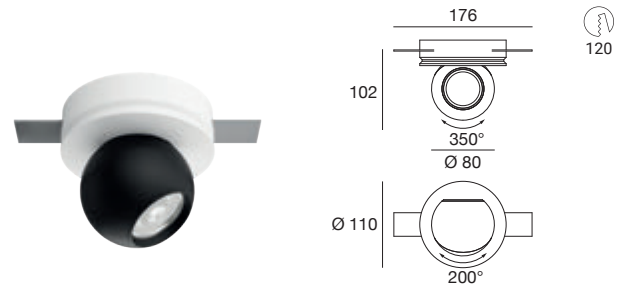

Product	Cct	Cri	lm S	lm D	Optics
White 9792	3000	90	995	822	Spot (15°)
Black 9793					
White 9794	3000	90	995	822	M.Flood (34°)
Black 9795					
White 9796	3000	90	995	822	W.Flood (62°)
Black 9797					

**Electronics Description**

<b>KIT0097</b>	DIMM DALI / 1-10 V / PUSH Driver (max. 13 art.)
<b>KIT0114</b>	ON/OFF Driver (max. 1 art.)

**Finishes**



Recessed

# Gypsum

Corpo in gesso verniciabile.

Paintable plaster body.



**Gypsum Coloring Power\_R** | powerLED 9,5 W DC 24 V

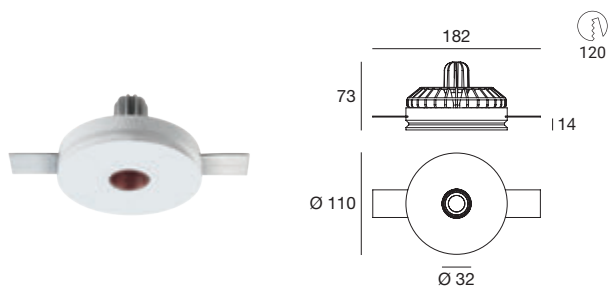

Product	Cct	Cri	lm S	lm D	Optics
8835	3000	80	660	520	N.Spot (15°)
8836	3000	80	660	536	M.Flood (39°)

**Electronics Description**

<b>KIT0097</b>	DIMM DALI / 1-10 V / PUSH Driver (max. 10 art.)
<b>KIT0114</b>	ON/OFF Driver (max. 1 art.)



Accessories included (1x)

**Gypsum Coloring Power\_Q** | powerLED 9,5 W DC 24 V

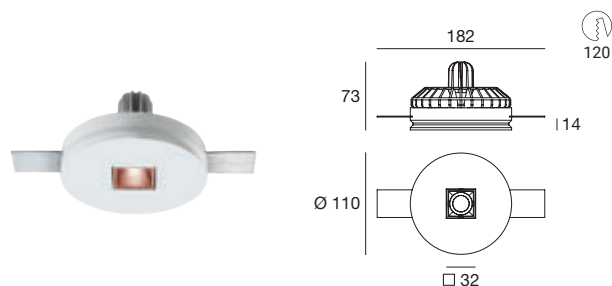

Product	Cct	Cri	lm S	lm D	Optics
8837	3000	80	660	520	N.Spot (15°)
8838	3000	80	660	536	M.Flood (39°)

**Electronics Description**

<b>KIT0097</b>	DIMM DALI / 1-10 V / PUSH Driver (max. 10 art.)
<b>KIT0114</b>	ON/OFF Driver (max. 1 art.)



Accessories included (1x)

**Finishes**

White

**Recessed**

**Gypsum Coloring\_R1** | 220-240 V | powerLED 7,5 W DC - 9 W AC

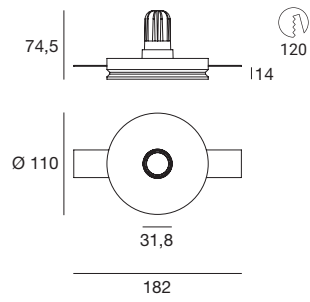

Product	Cct	Cri	Im S	Im D	Optics
8819	3000	80	540	441	N.Spot (15°)
8815	3000	80	540	455	M.Flood (39°)



Accessories included (1x)

**Gypsum Coloring\_Q1** | 220-240 V | powerLED 7,5 W DC - 9 W AC

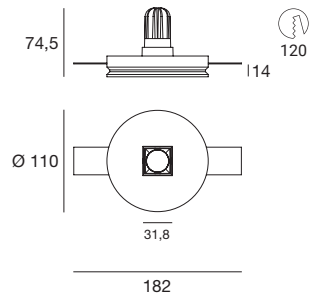

Product	Cct	Cri	Im S	Im D	Optics
8827	3000	80	540	441	N.Spot (15°)
8823	3000	80	540	455	M.Flood (39°)



Accessories included (1x)

**Gypsum Coloring\_R3** | 220-240 V | powerLED 20 W DC - 23 W AC

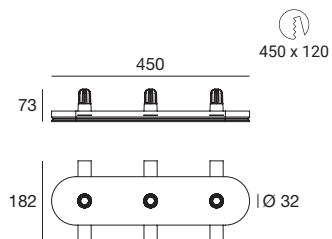

Product	Cct	Cri	lm S	lm D	Optics
8831	3000	80	1622	1321	N.Spot (15°)
8832	3000	80	1622	1363	M.Flood (39°)



Accessories included (3x)

**Example of separate ON/OFF switching**

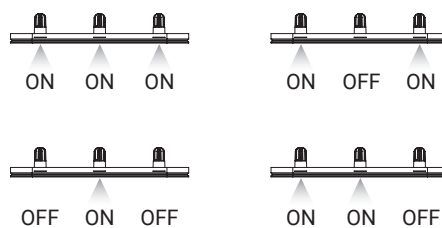

**Gypsum Coloring\_Q3** | 220-240 V | powerLED 20 W DC - 23 W AC

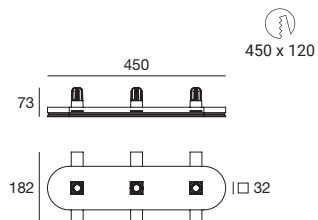

Product	Cct	Cri	lm S	lm D	Optics
8833	3000	80	1622	1321	N.Spot (15°)
8834	3000	80	1622	1363	M.Flood (39°)



Accessories included (3x)

**Example of separate ON/OFF switching**

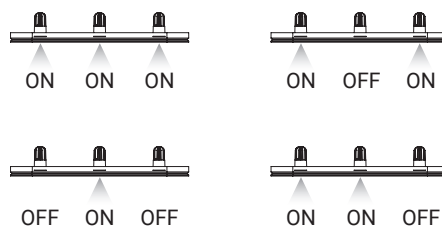

**Finishes**

White

Recessed



**Gypsum\_R** | arrayLED 7 W DC 700 mA

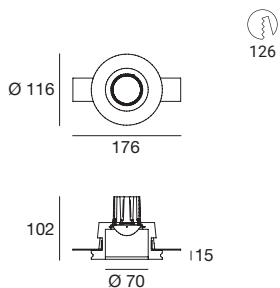

Product	Cct	Cri	Im S	Im D	Optics
□ 8866	3000	80	815	385	Diffused
□ 8866N	4000	80	807	422	Diffused

Electronics	Description
☒ 99243	ON/OFF Driver (max. 1 art.)
☒ 99147	ON/OFF Driver (1-3 art.)
☒ 99115	1-10 V / PUSH (1-3 art.)
☒ 99344	DALI / PUSH (1-3 art.)

Accessory	Description
60830	Shim (plasterboard 12,5 mm kit - 4 pieces)
60860	Glass

**Gypsum\_Eye1** | arrayLED 7 W DC 700 mA

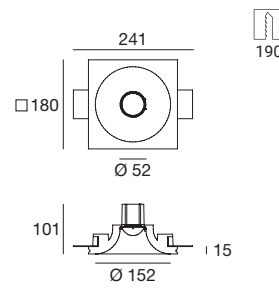

Product	Cct	Cri	Im S	Im D	Optics
□ 8867	3000	80	815	511	Diffused
□ 8867N	4000	80	807	555	Diffused

Electronics	Description
☒ 99243	ON/OFF Driver (max. 1 art.)
☒ 99147	ON/OFF Driver (1-3 art.)
☒ 99115	1-10 V / PUSH (1-3 art.)
☒ 99344	DALI / PUSH (1-3 art.)

Accessory	Description
60830	Shim (plasterboard 12,5 mm kit - 4 pieces)





**Gypsum\_01** | arrayLED 7 W DC 700 mA

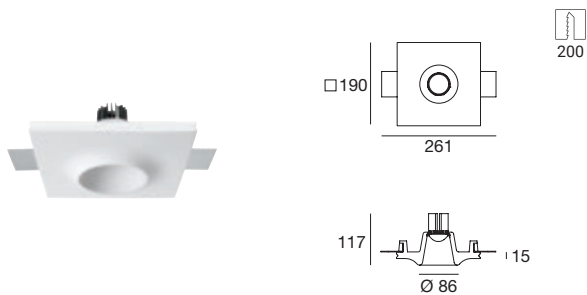

Product	Cct	Cri	lm S	lm D	Optics
8861	3000	80	815	455	Diffused
8861N	4000	80	807	500	Diffused

Electronics	Description
99243	ON/OFF Driver (max. 1 art.)
99147	ON/OFF Driver (1-3 art.)
99115	1-10 V / PUSH (1-3 art.)
99344	DALI / PUSH (1-3 art.)

Accessory	Description
60830	Shim (plasterboard 12,5 mm kit - 4 pieces)

**Gypsum\_03** | arrayLED 19 W DC 500 mA

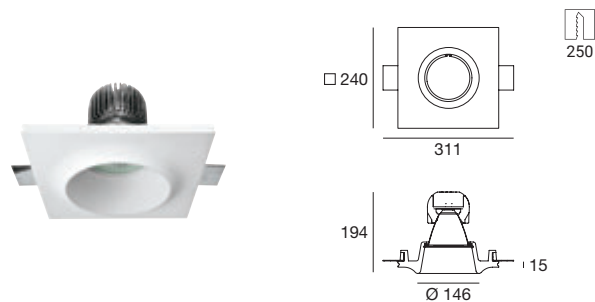

Product	Cct	Cri	lm S	lm D	Optics
60824W45	3000	80	2292	1305	M.Flood (46°)
60824N45	4000	80	2292	1305	M.Flood (46°)

Electronics	Description
99106	ON/OFF Driver (max. 1 art.)
99115	1-10 V / PUSH (max. 1 art.)
99344	DALI / PUSH (max. 1 art.)

Accessory	Description
60830	Shim (plasterboard 12,5 mm kit - 4 pieces)

**Gypsum\_QD1** | arrayLED 10 W DC 250 mA

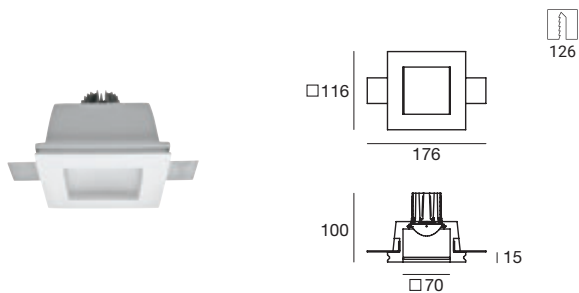

Product	Cct	Cri	Im S	Im D	Optics
63830W00	3000	80	1189	796	Diffused
63830N00	4000	80	1189	796	Diffused

Electronics	Description
62424	ON/OFF Driver (max. 1 art.)
62431	1-10 V / PUSH (max. 1 art.)
62432	DALI / PUSH (max. 1 art.)

Accessory	Description
60830	Shim (plasterboard 12,5 mm kit - 4 pieces)

**Gypsum\_QC2** | arrayLED 7 W DC 700 mA

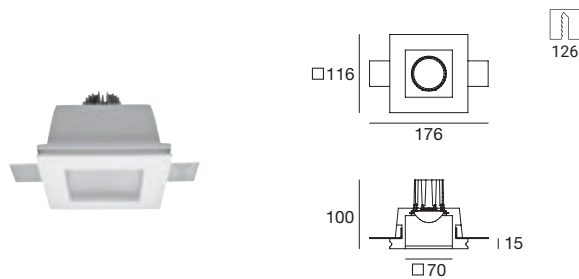

Product	Cct	Cri	Im S	Im D	Optics
8865	3000	80	815	456	Diffused
8865N	4000	80	807	502	Diffused

Electronics	Description
99243	ON/OFF Driver (max. 1 art.)
99147	ON/OFF Driver (1-3 art.)
99115	1-10 V / PUSH (1-3 art.)
99344	DALI / PUSH (1-3 art.)

Accessory	Description
60830	Shim (plasterboard 12,5 mm kit - 4 pieces)
60840	Glass

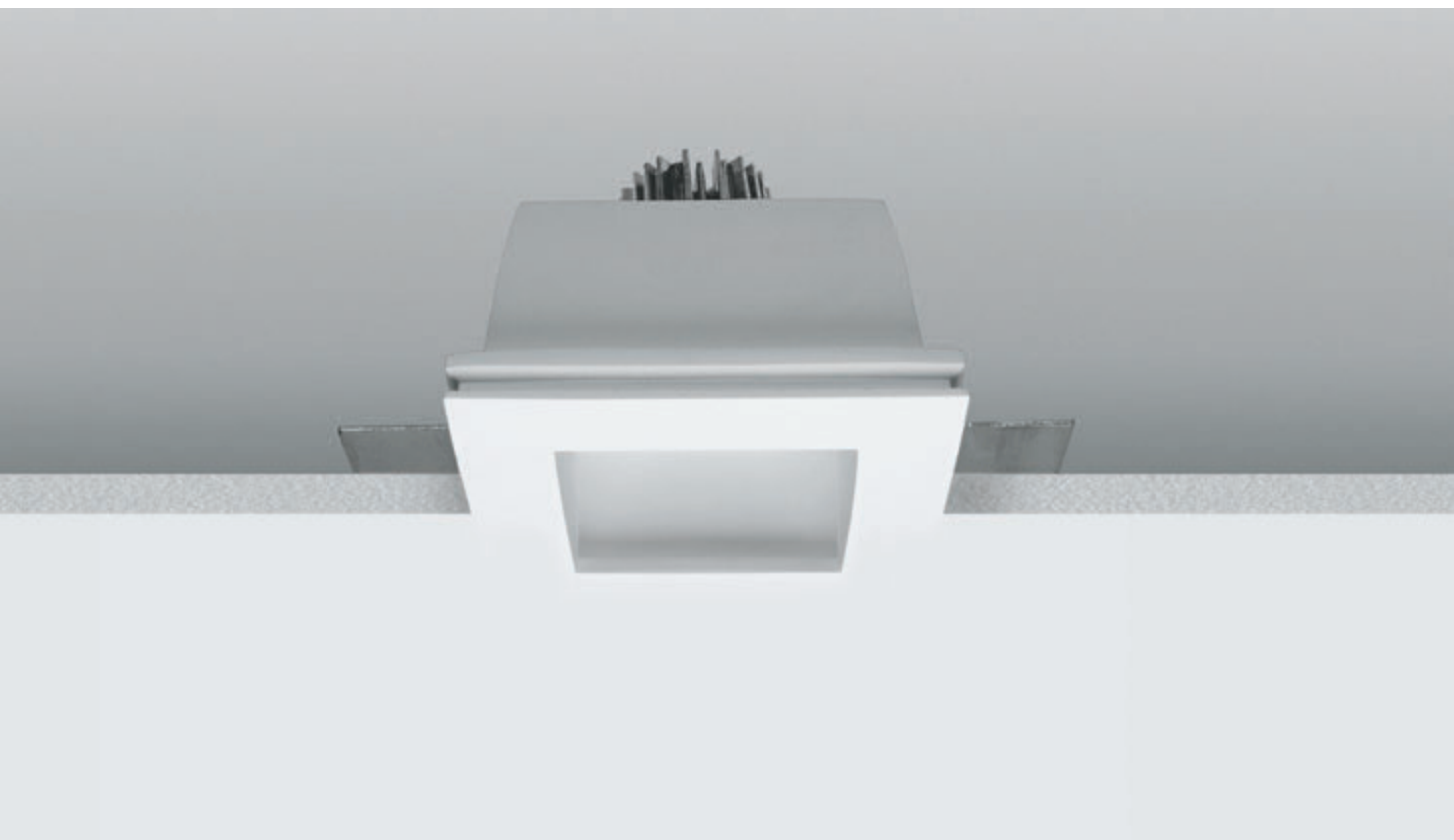

**Gypsum\_QRD** | arrayLED 7 W DC 700 mA

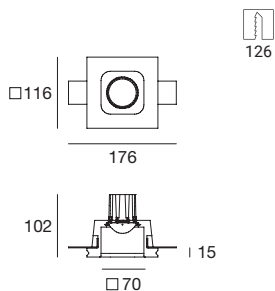

126

Product	Cct	Cri	Im S	Im D	Optics
8870	3000	80	815	475	Diffused
8870N	4000	80	807	523	Diffused

**Electronics Description**

99243	ON/OFF Driver (max. 1 art.)
99147	ON/OFF Driver (1-3 art.)
99115	1-10 V / PUSH (1-3 art.)
99344	DALI / PUSH (1-3 art.)

**Accessory Description**

60830	Shim (plasterboard 12,5 mm kit - 4 pieces)
60840	Glass

**Gypsum\_QD2** | arrayLED 12,5 W DC 350 mA

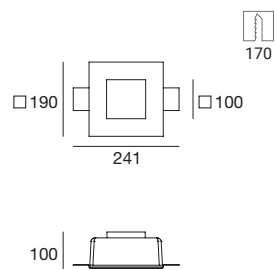

170

Product	Cct	Cri	Im S	Im D	Optics
63820W00	3000	80	1679	1190	Diffused
63820N00	4000	80	1679	1190	Diffused

**Electronics Description**

99126	ON/OFF Driver (max. 1 art.)
99115	1-10 V / PUSH (max. 1 art.)
99344	DALI / PUSH (max. 1 art.)

**Accessory Description**

60830	Shim (plasterboard 12,5 mm kit - 4 pieces)
-------	--

**Finishes**

White
-------



Recessed

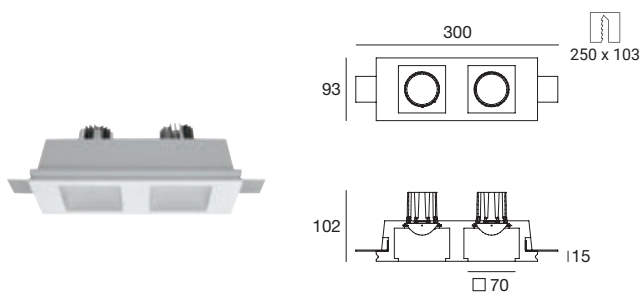

Product	Cct	Cri	Im S	Im D	Optics
8871	3000	80	1660	913	Diffused
8871N	4000	80	1646	1004	Diffused

**Electronics Description**

99147	ON/OFF Driver (max. 1 art.)
99115	1-10 V / PUSH (max. 1 art.)
99345	DALI / PUSH (max. 1 art.)

**Accessory Description**

60830	Shim (plasterboard 12,5 mm kit - 4 pieces)
60840	Glass

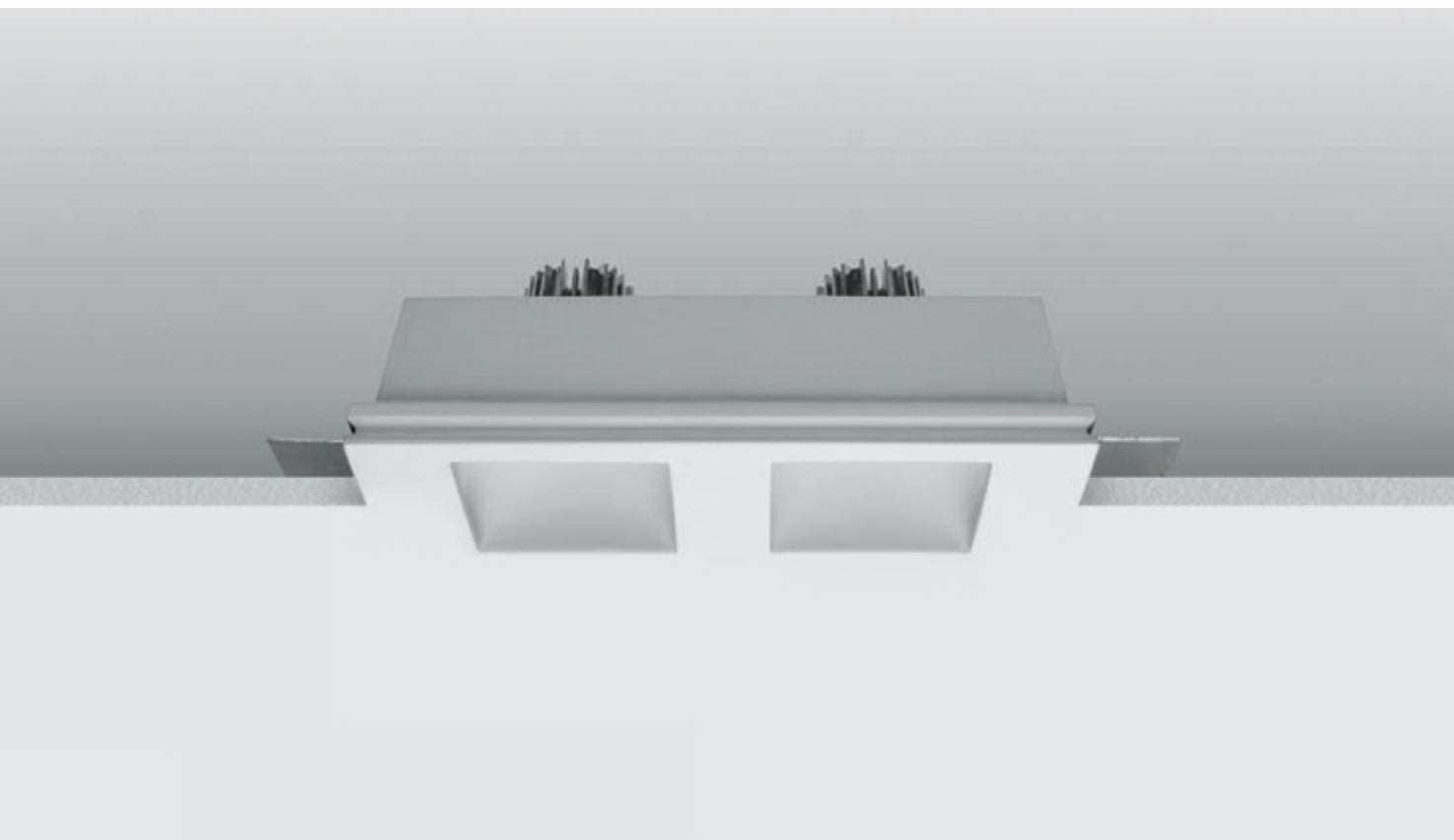

**Gypsum\_D1** | 220-240 V | topLED 12 W DC - 14 W AC

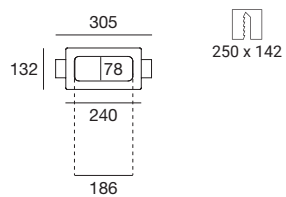

Product	Cct	Cri	lm S	lm D	Optics
8872	3000	80	1588	676	Diffused

**Accessory Description**

60830	Shim (plasterboard 12,5 mm kit - 4 pieces)
-------	--

**Gypsum\_D2** | 220-240 V | topLED 31 W DC - 35 W AC

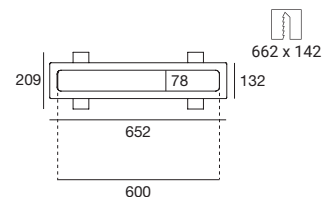

Product	Cct	Cri	lm S	lm D	Optics
8873	3000	80	4149	1916	Diffused

**Accessory Description**

60830	Shim (plasterboard 12,5 mm kit - 4 pieces)
-------	--





**Gypsum\_SR** | arrayLED 7 W DC 700 mA

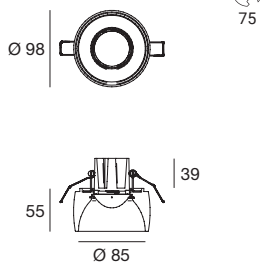

Product	Cct	Cri	Im S	Im D	Optics
<input type="checkbox"/> <b>8864</b>	3000	80	815	485	Diffused
<input type="checkbox"/> <b>8864N</b>	4000	80	807	534	Diffused

**Electronics Description**

<b>99243</b>	ON/OFF Driver (max. 1 art.)
<b>99147</b>	ON/OFF Driver (1-3 art.)
<b>99115</b>	1-10 V / PUSH (1-3 art.)
<b>99344</b>	DALI / PUSH (1-3 art.)

**Gypsum\_SQ** | arrayLED 7 W DC 700 mA

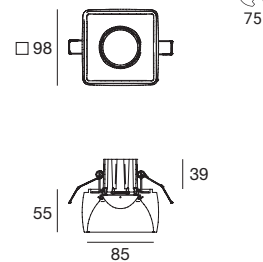

Product	Cct	Cri	Im S	Im D	Optics
<input type="checkbox"/> <b>8863</b>	3000	80	815	485	Diffused
<input type="checkbox"/> <b>8863N</b>	4000	80	807	534	Diffused

**Electronics Description**

<b>99243</b>	ON/OFF Driver (max. 1 art.)
<b>99147</b>	ON/OFF Driver (1-3 art.)
<b>99115</b>	1-10 V / PUSH (1-3 art.)
<b>99344</b>	DALI / PUSH (1-3 art.)

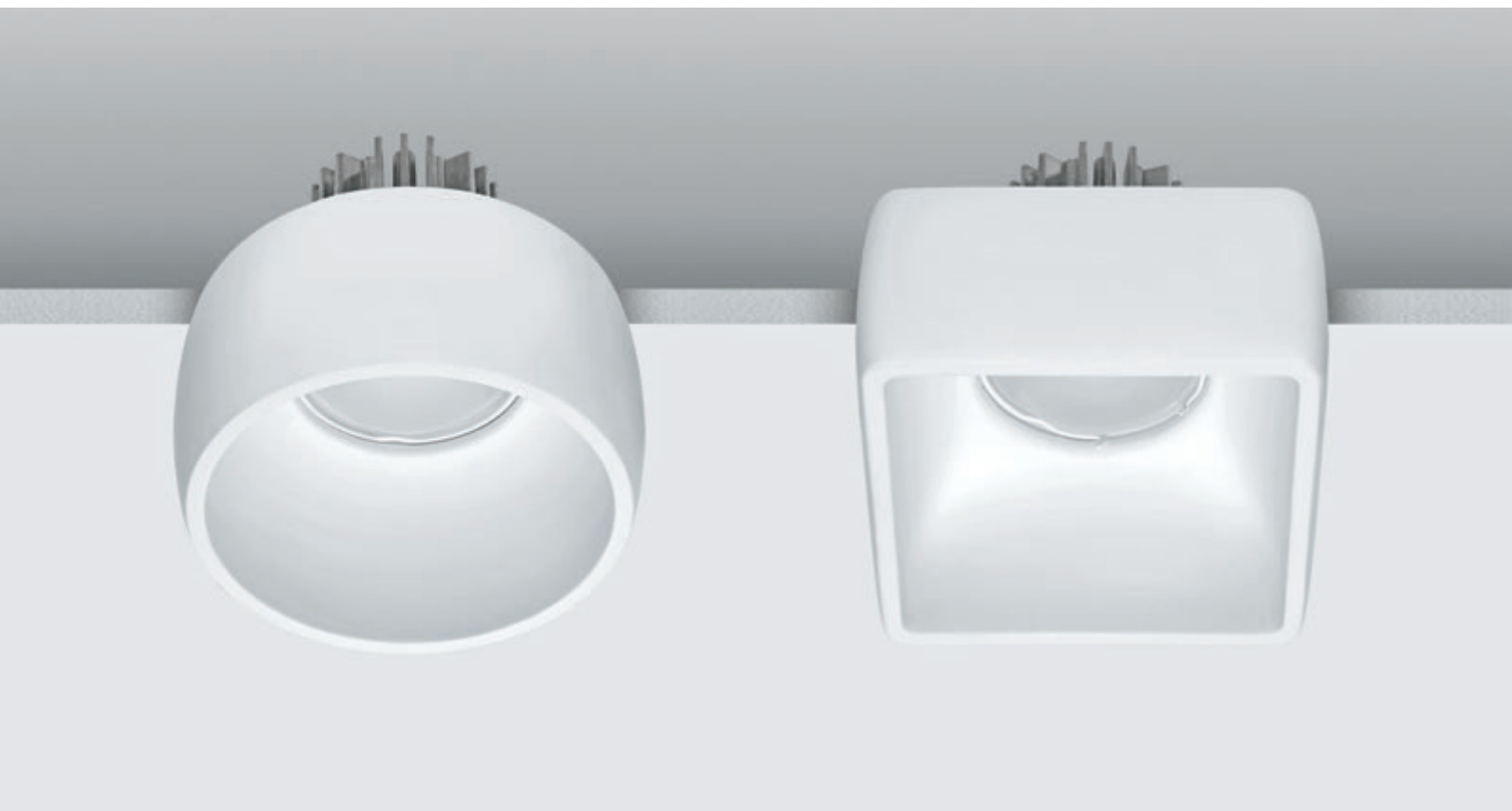

**Finishes**

White

**Recessed**





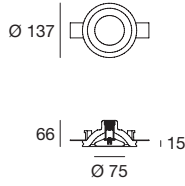

147

Product	Cct	Cri	Im S	Im D	Optics
60811W00	3000	80	126	25	Diffused
60811N00	4000	80	116	28	Diffused

**Electronics Description**

Electronics	Description
89144	ON/OFF Driver (1-2 art.)
89145	ON/OFF Driver (3-6 art.)
99115	1-10 V / PUSH (1-15 art.)
99344	DALI / PUSH (1-15 art.)

**Accessory Description**

Accessory	Description
60830	Shim (plasterboard 12,5 mm kit - 4 pieces)
60840	Glass

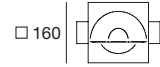

170



Product	Cct	Cri	Im S	Im D	Optics
60910W00	3000	80	116	41	Diffused
60910N00	4000	80	116	41	Diffused

**Electronics Description**

Electronics	Description
89144	ON/OFF Driver (1-2 art.)
89145	ON/OFF Driver (3-6 art.)
99115	1-10 V / PUSH (1-15 art.)
99344	DALI / PUSH (1-15 art.)

**Accessory Description**

Accessory	Description
60830	Shim (plasterboard 12,5 mm kit - 4 pieces)
60837	Outer casing

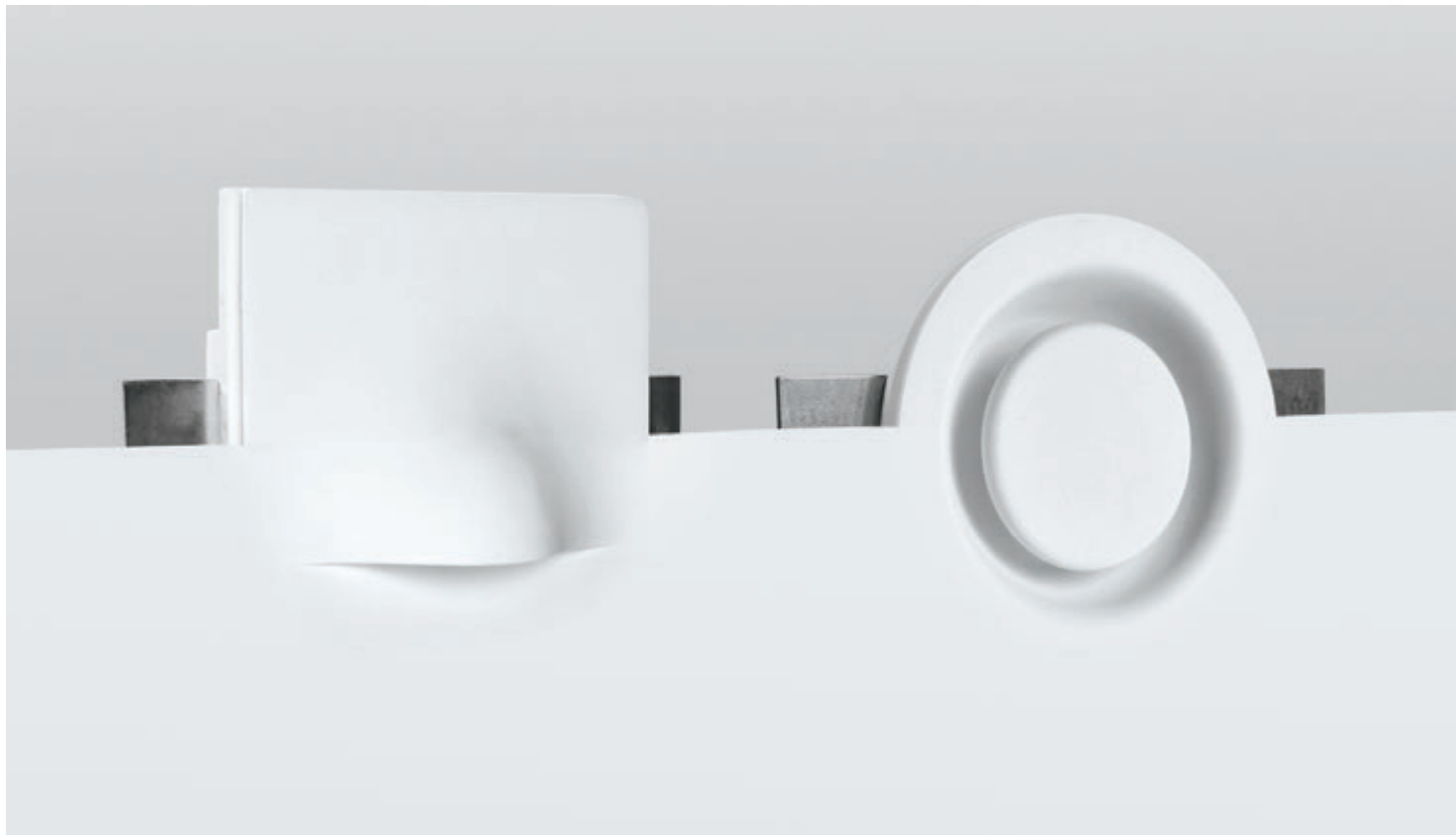

**Finishes**

White
-------

**Recessed**

**Gypsum\_WR1** | powerLED 1 W DC 350 mA

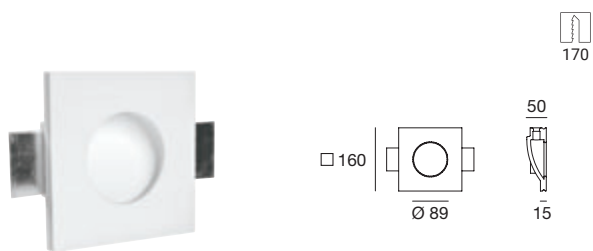

Product	Cct	Cri	Im S	Im D	Optics
60813W00	3000	80	116	49	Diffused
60813N00	4000	80	116	49	Diffused

Electronics	Description
89144	ON/OFF Driver (1-2 art.)
89145	ON/OFF Driver (3-6 art.)
99115	1-10 V / PUSH (1-15 art.)
99344	DALI / PUSH (1-15 art.)

Accessory	Description
60830	Shim (plasterboard 12,5 mm kit - 4 pieces)
60836	Outer casing

**Gypsum\_WR2** | powerLED 1 W DC 350 mA

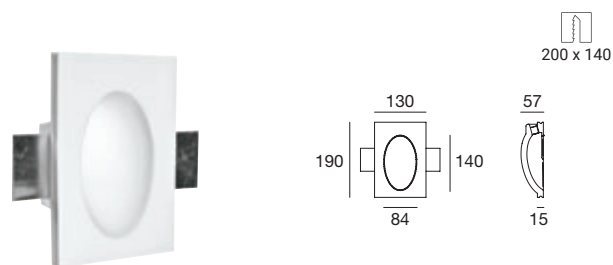

Product	Cct	Cri	Im S	Im D	Optics
60815W00	3000	80	126	46	Diffused
60815N00	4000	80	126	46	Diffused

Electronics	Description
89144	ON/OFF Driver (1-2 art.)
89145	ON/OFF Driver (3-6 art.)
99115	1-10 V / PUSH (1-15 art.)
99344	DALI / PUSH (1-15 art.)

Accessory	Description
60830	Shim (plasterboard 12,5 mm kit - 4 pieces)
60838	Outer casing

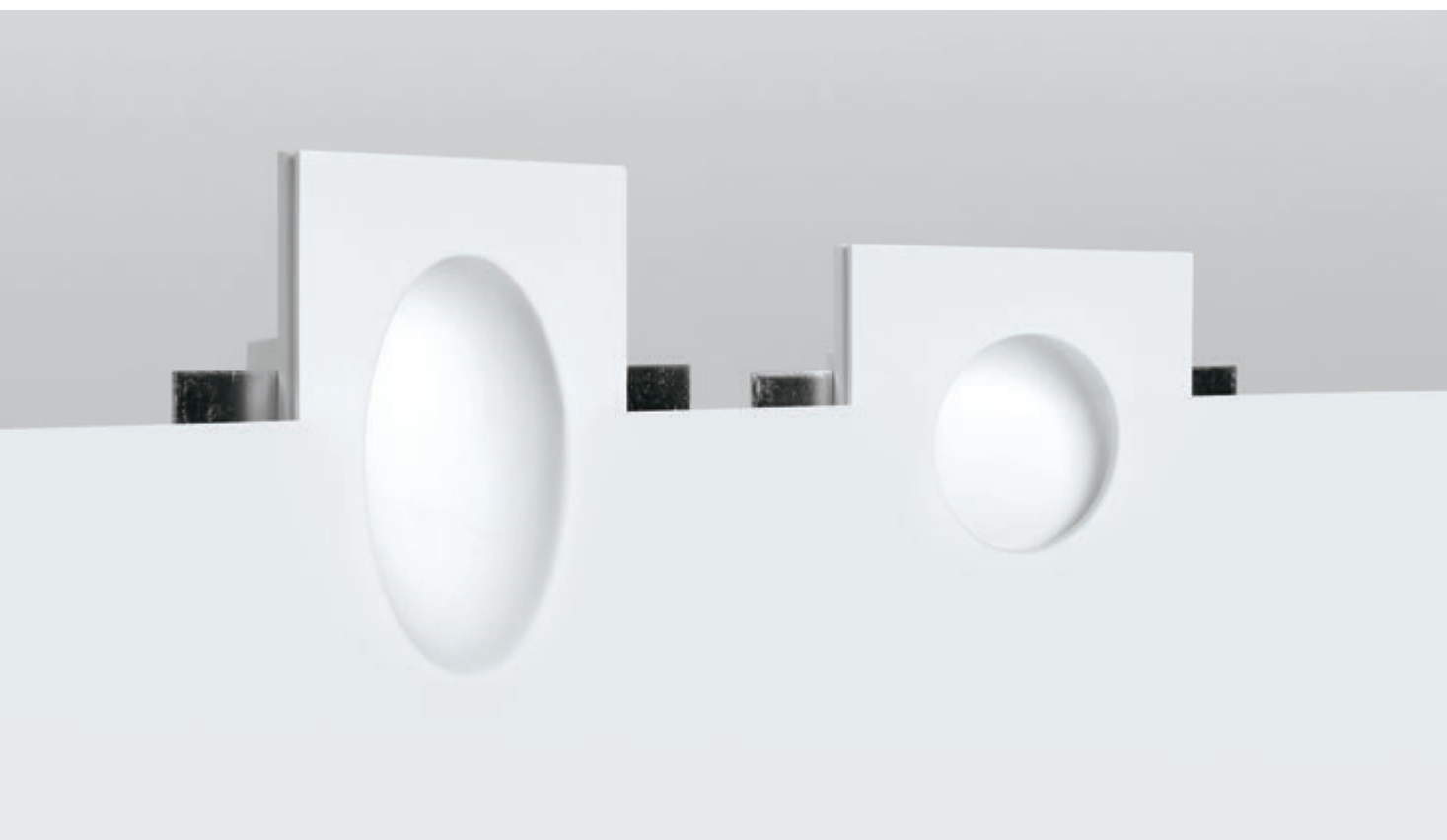

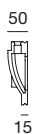
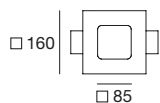

Product	Cct	Cri	Im S	Im D	Optics
60814W00	3000	80	126	43	Diffused
60814N00	4000	80	126	43	Diffused

**Electronics Description**

89144	ON/OFF Driver (1-2 art.)
89145	ON/OFF Driver (3-6 art.)
99115	1-10 V / PUSH (1-15 art.)
99344	DALI / PUSH (1-15 art.)

**Accessory Description**

60830	Shim (plasterboard 12,5 mm kit - 4 pieces)
60837	Outer casing



**Gypsum\_WF1** | powerLED 1 W DC 350 mA

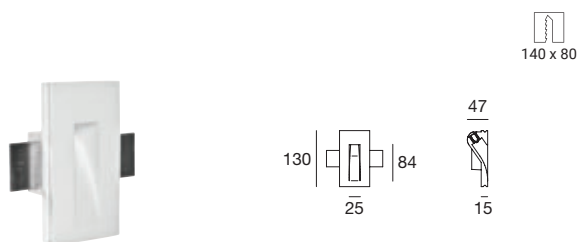

Product	Cct	Cri	Im S	Im D	Optics
60920W70	3000	80	116	31	E.W.Flood (109°)
60920N70	4000	80	116	31	E.W.Flood (109°)

Electronics	Description
89144	ON/OFF Driver (1-2 art.)
89145	ON/OFF Driver (3-6 art.)
99115	1-10 V / PUSH (1-15 art.)
99344	DALI / PUSH (1-15 art.)

Accessory	Description
60830	Shim (plasterboard 12,5 mm kit - 4 pieces)
61270	Outer casing

**Gypsum\_WF2** | powerLED 1 W DC 350 mA

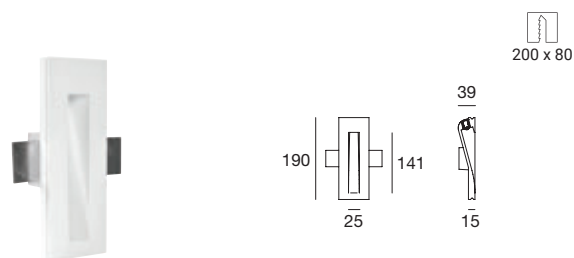

Product	Cct	Cri	Im S	Im D	Optics
60930W70	3000	80	116	46	E.W.Flood (131°)
60930N70	4000	80	116	46	E.W.Flood (131°)

Electronics	Description
89144	ON/OFF Driver (1-2 art.)
89145	ON/OFF Driver (3-6 art.)
99115	1-10 V / PUSH (1-15 art.)
99344	DALI / PUSH (1-15 art.)

Accessory	Description
60830	Shim (plasterboard 12,5 mm kit - 4 pieces)
61280	Outer casing

**Gypsum\_WF3** | 220-240 V | powerLED 1,5 W DC - 3 W AC

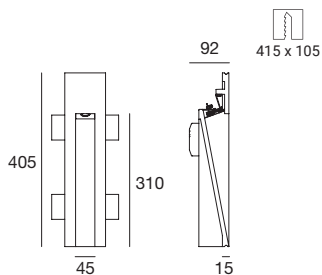

Product	Cct	Cri	lm S	lm D	Optics
60680W70	3000	80	175	84	W.Flood
60680N70	4000	80	175	84	W.Flood

**Accessory Description**

60830	Shim (plasterboard 12,5 mm kit - 4 pieces)
64180	Outer casing

**Gypsum\_WF4** | 220-240 V | powerLED 6 W DC - 8 W AC

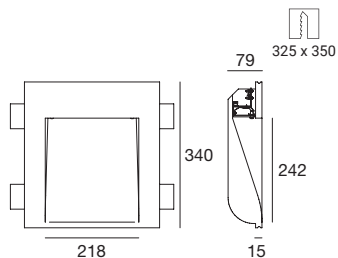

Product	Cct	Cri	lm S	lm D	Optics
61390W00	3000	80	538	316	Diffused
61390N00	4000	80	538	316	Diffused

**Accessory Description**

60830	Shim (plasterboard 12,5 mm kit - 4 pieces)
61290	Outer casing



**Finishes**

White

Recessed

# One to one

Diffusore in polimetilmetacrilato sabbiato.  
Montatura in alluminio verniciato bianco raggrinzante.



194

Sandblasted polymethylmethacrylate diffuser.  
Wrinkle effect white painted aluminium mount.



## One to one\_C | topLED 10 W DC 500 mA

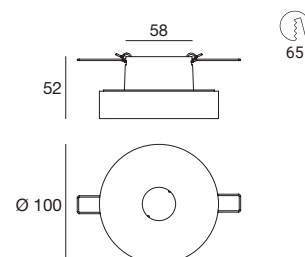

Product	Cct	Cri	lm S	lm D	Optics
7619	3000	90	1082	820	Diffused

### Electronics Description

KIT0064	Driver (max. 1 art.)
KIT0065	Driver (max. 1-2 art.)

### Accessory Description

KIT0026	Phase-cut dimmer (max. 100 W)
---------	-------------------------------

# Outlook

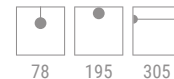

Corpo in alluminio verniciato bianco  
raggrinzante. Diffusore in vetro trasparente.

Body in wrinkle effect white painted  
aluminium. Diffuser in clear glass.

## Outlook\_C | arrayLED 11 W DC 500 mA

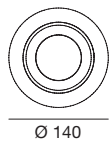
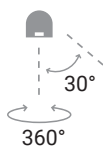

Product	Cct	Cri	lm S	lm D	Optics
8470	3000	90	1082	820	Diffused

### Electronics Description

<b>KIT0064</b>	Phase-cut driver (max. 1 art.)
<b>KIT0065</b>	Phase-cut driver (max. 1-2 art.)

### Accessory Description

<b>KIT0026</b>	Phase-cut dimmer (max. 100 W)
----------------	-------------------------------



### Finishes

White

### Recessed







**PENDANT  
LUMINAIRES**

# Antigua

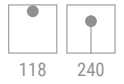

Diffusore in vetro trasparente con bordo sabbiato. Elemento centrale e rosone in metallo verniciato bianco raggrinzante.

Diffuser in clear glass with sandblasted edge. Central element and ceiling rose in wrinkle effect white painted metal.



## Antigua\_P | 220-240 V | stripLED 35 W DC - 38 W AC

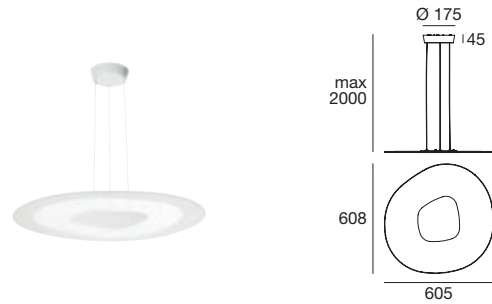

Product	Cct	Cri	lm S	lm D	Optics
90348	3000	90	3996	2945	Diffused

## Antigua\_P | 220-240 V | stripLED 43 W DC - 46 W AC

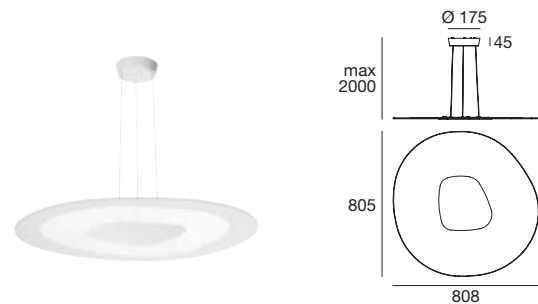

Product	Cct	Cri	lm S	lm D	Optics
90349	3000	90	4596	3760	Diffused

# Antille







120

Diffusore in vetro trasparente con bordo sabbiato asimmetrico. Elemento centrale in metallo nelle finiture galvaniche rame, oro, cromo oppure verniciato bianco raggrinzante. Rosone in metallo verniciato bianco raggrinzante.

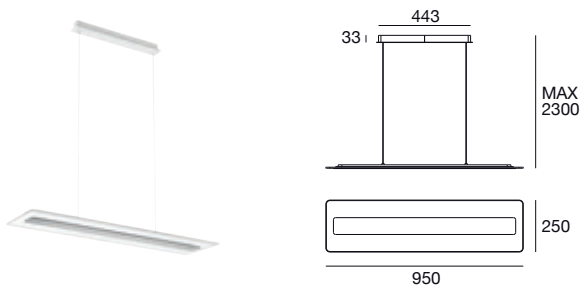
Diffuser in clear glass with asymmetrical sandblasted edge. Central element in metal in copper, gold, chrome galvanic finishes or white wrinkle effect finish. Ceiling rose in wrinkle effect white painted metal.

**Antille\_P** | 220-240 V | stripLED 44 W DC - 45 W AC



Product	Cct	Cri	lm S	lm D	Optics
 8936	3000	90	5174	4278	Diffused
 8937					
 8938					
 8939					

## Asymmetric profile

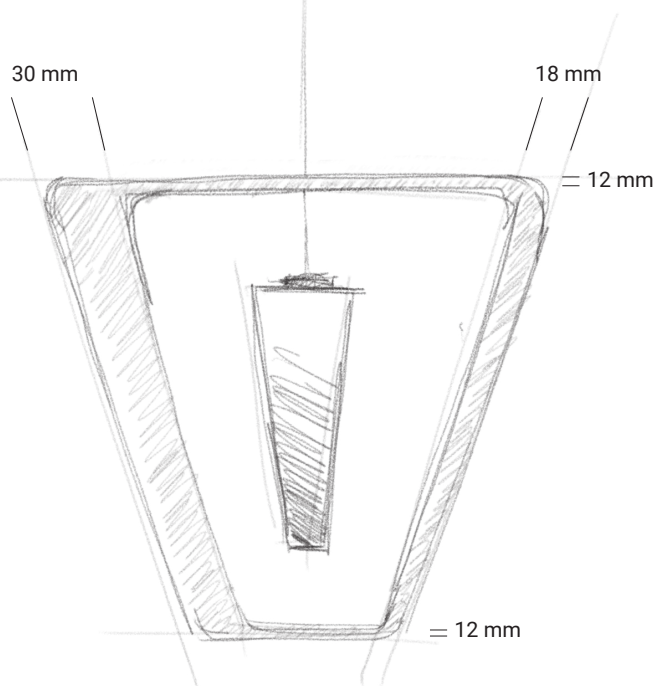

## Finishes

 White  Chrome  Copper  Gold

Pendant luminaires

# Aruba



122

Diffusore in vetro trasparente con bordo sabbiato asimmetrico. Elemento centrale in metallo nelle finiture galvaniche rame, oro, cromo oppure verniciato bianco raggrinzante. Rosone in metallo verniciato bianco raggrinzante.

Diffuser in clear glass with asymmetrical sandblasted edge. Central element in metal in copper, gold, chrome galvanic finishes or white wrinkle effect finish. Ceiling rose in wrinkle effect white painted metal.



**Aruba\_P** | 220-240 V | stripLED 17 W DC - 19 W AC

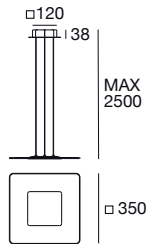
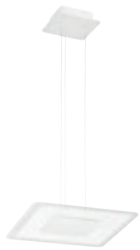

Product	Cct	Cri	lm S	lm D	Optics
8928	3000	90	2212	1794	Diffused
8929					
8930					
8931					

**Aruba\_P** | 220-240 V | stripLED 35 W DC - 38 W AC

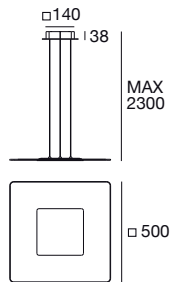

Product	Cct	Cri	lm S	lm D	Optics
8932	3000	90	4228	3388	Diffused
8933					
8934					
8935					



**Finishes**

- White
- Chrome
- Copper
- Gold

**Pendant luminaires**

# Birba



Corpo in ottone lucido, alluminio lucido o alluminio verniciato bianco raggrinzante. Rosone in metallo verniciato bianco raggrinzante.

Body in polished brass, polished or wrinkle effect white painted aluminium. Ceiling rose in wrinkle effect white painted metal.



## Attacco E27

Scegli tra le tante lampadine LED E27 presenti sul mercato: con bulbo grande, piccolo, sferico, a goccia, total white o a filamento... per una luce davvero personale.

### E27 fitting

Choose from the many E27 LED bulbs on the market – big bulb, small bulb, spherical bulb, teardrop bulb, total white bulb or filament bulb ... for truly personalised illumination.

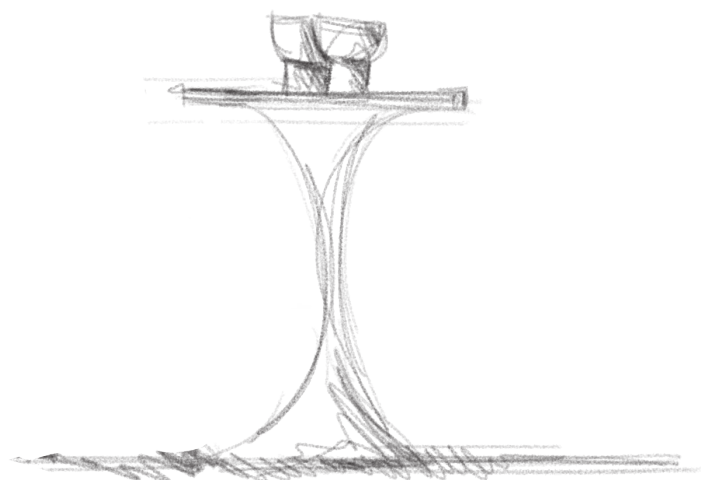
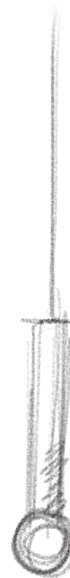
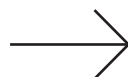
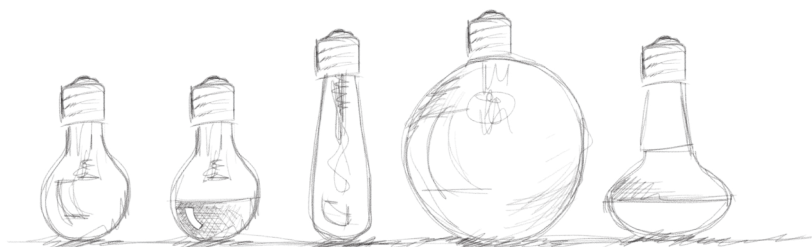

## Attacco regolabile GU10

Puoi posizionare la lampadina GU10 a filo con il bordo lampada per avere la massima ampiezza del fascio luminoso oppure leggermente recessa per un miglior controllo del glaring.

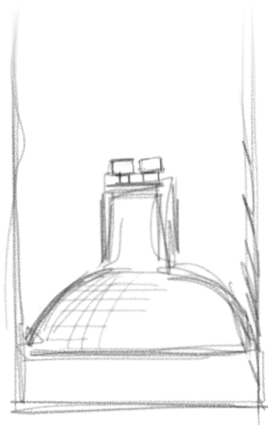

## Adjustable GU10 fitting

Position the GU10 bulb flush with the lamp edge for maximum beam width or even slightly recessed for better glare control.

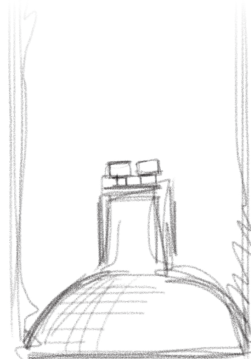





Birba\_P | 220-240 V | GU10 / E27

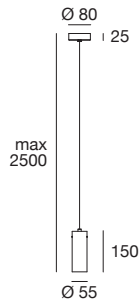
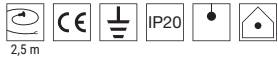

Product	Source
9355	GU10
9357	Max 7 W LED Bulb (not included)
9358	

Product	Source
9403	E27
9405	Max 22 W LED Bulb (not included)
9406	

Birba\_P | 220-240 V | GU10 / E27

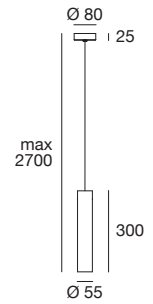

Product	Source
9361	GU10
9363	Max 7 W LED Bulb (not included)
9364	

Product	Source
9409	E27
9411	Max 22 W LED Bulb (not included)
9412	

Birba\_P | 220-240 V | GU10 / E27

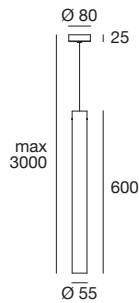
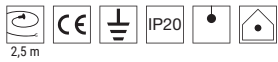

Product	Source
9367	GU10
9369	Max 7 W LED Bulb (not included)
9370	

Product	Source
9415	E27
9417	Max 22 W LED Bulb (not included)
9418	

Finishes



Pendant luminaires

# Crew

147/149

Corpo in metallo verniciato in varie finiture e combinazioni cromatiche. Diffusore in polimetilmetacrilato opalino. Kit sospensione con rosone in metallo verniciato bianco o nero raggrinzante.

Painted metal body in various finishes and colour combinations. Diffuser in opal polymethylmethacrylate. Suspension kit with ceiling rose in wrinkle effect white or black painted metal.





Product	Cct	Cri	lm S	lm D	Optics
White 8270	3000	80	1253	900	Diffused
Dark grey 8271					
Burnished 8272					

Suspension kit REQUIRED

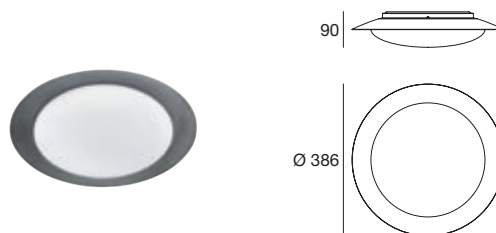

Product	Cct	Cri	lm S	lm D	Optics
White 8275	3000	80	1628	1200	Diffused
Dark grey 8276					
Burnished 8277					

Suspension kit REQUIRED

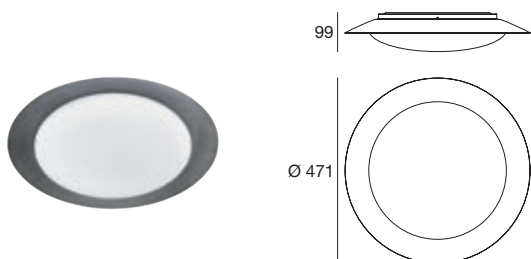

Product	Cct	Cri	lm S	lm D	Optics
White 8280	3000	80	2460	1800	Diffused
Dark grey 8281					
Burnished 8282					

Suspension kit REQUIRED



Finishes



### Da plafone a sospensione in poche mosse!

Con il kit sospensione acquistabile separatamente puoi trasformare Crew in una lampada a sospensione in un attimo. Il kit è completo di rosone, cavi di sostegno e cavo di alimentazione: collegali alla tua Crew e il gioco è fatto!

### From ceiling light to pendant light in just a few steps.

With the suspension kit (purchasable separately), transform Crew into a pendant light in no time at all. The kit comes complete with rosette, support cables and power cable – just connect them to your Crew and you're all set!

NEW

**KIT0120**  
White suspension kit  
2 m

**KIT0121**  
Black suspension kit  
2 m

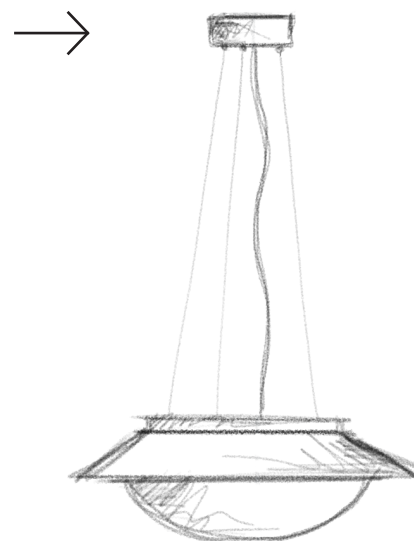



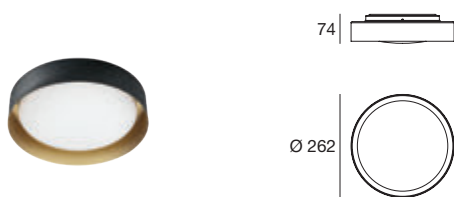

Product	Cct	Cri	Im S	Im D	Optics
8285	3000	80	1253	824	Diffused
8286					
8287					
8288					
8289					

Suspension kit REQUIRED

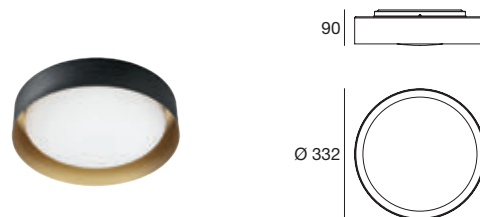

Product	Cct	Cri	Im S	Im D	Optics
8292	3000	80	1628	1097	Diffused
8293					
8294					
8295					
8296					

Suspension kit REQUIRED

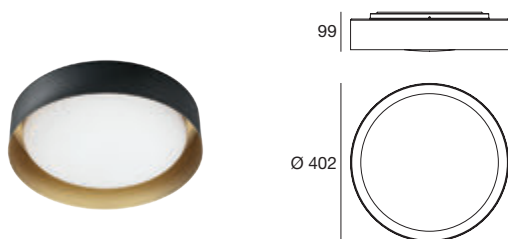

Product	Cct	Cri	Im S	Im D	Optics
8299	3000	80	2460	1648	Diffused
8300					
8301					
8302					
8303					

Suspension kit REQUIRED

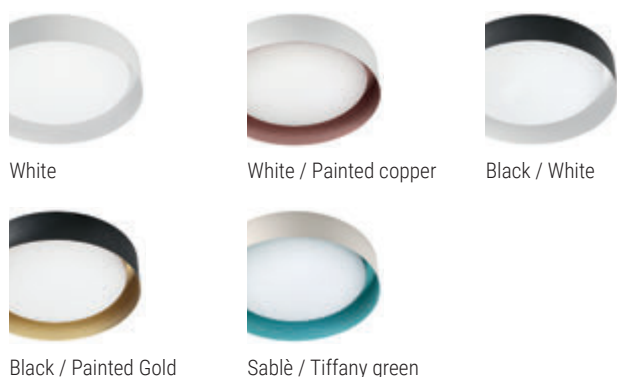

Finishes



### Da plafone a sospensione in poche mosse!

Con il kit sospensione acquistabile separatamente puoi trasformare Crew in una lampada a sospensione in un attimo. Il kit è completo di rosone, cavi di sostegno e cavo di alimentazione: collegali alla tua Crew e il gioco è fatto!

### From ceiling light to pendant light in just a few steps.

With the suspension kit (purchasable separately), transform Crew into a pendant light in no time at all. The kit comes complete with rosette, support cables and power cable – just connect them to your Crew and you're all set!

NEW

**KIT0120**  
White suspension kit  
2 m

**KIT0121**  
Black suspension kit  
2 m

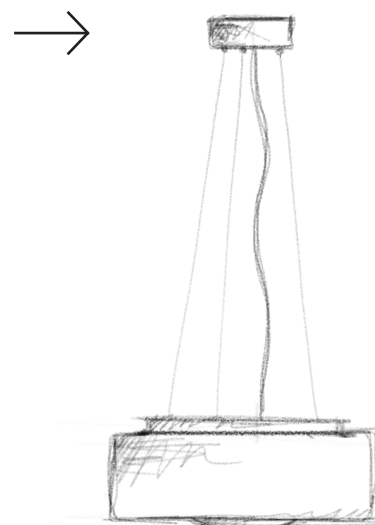

# Dubligh

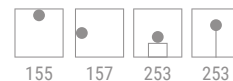

Diffusore in polimetilmetacrilato satinato.  
Rosone in metallo verniciato bianco raggrinzante.

Satin-finish polymethylmethacrylate diffuser.  
Ceiling rose in wrinkle effect white painted metal.



**Dubligh\_PQ** | 220-240 V | topLED 38 W DC - 42 W AC

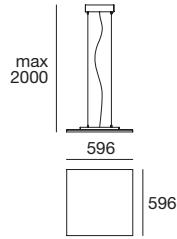

Product	Cct	Cri	Im S	Im D	Optics
<input type="checkbox"/> 7493	3000	80	4485	3607	Diffused

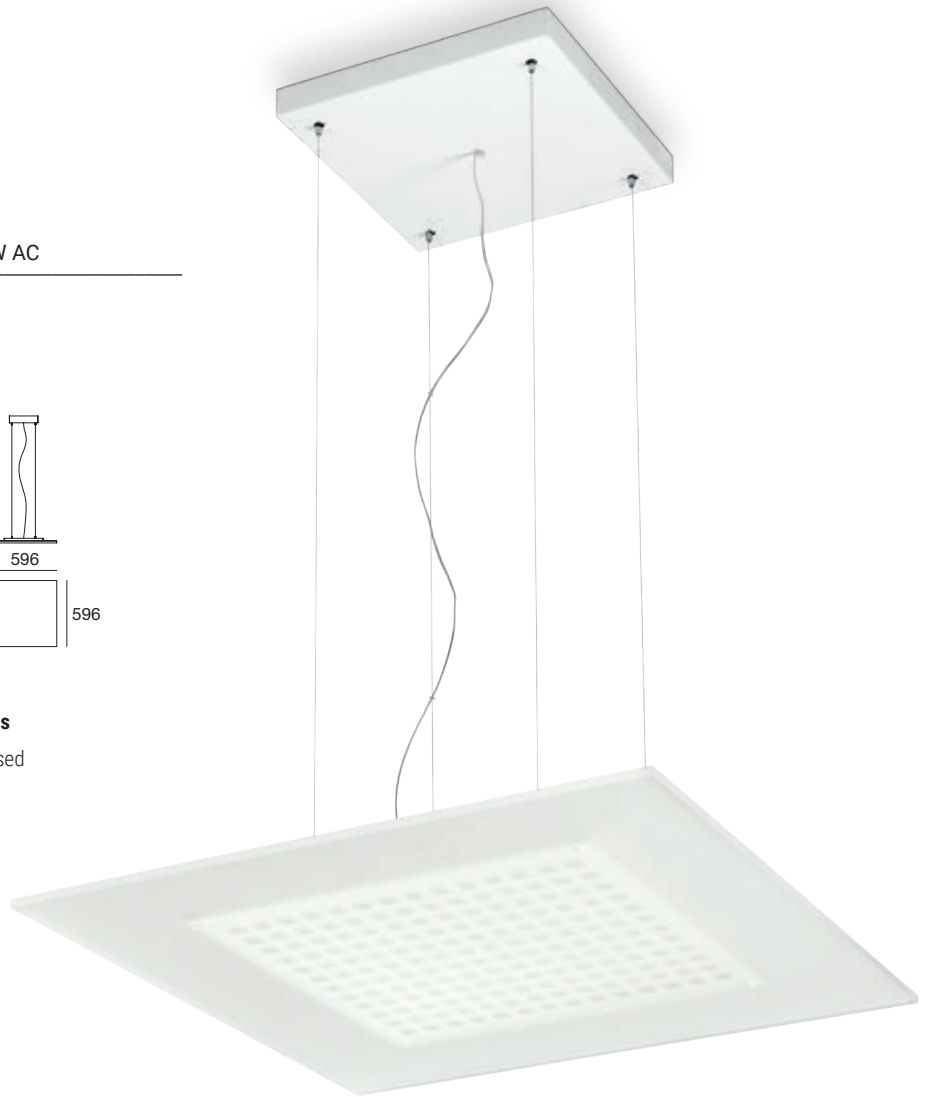

**Dubligh\_PB** | 220-240 V | topLED 32 W DC - 35 W AC

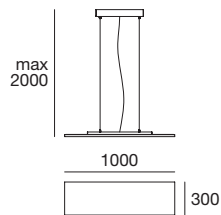

Product	Cct	Cri	Im S	Im D	Optics
<input type="checkbox"/> 7494	3000	80	4200	2821	Diffused

**Finishes**

White

# Halfpipe 2



172 256

Corpo in alluminio lucido o verniciato bianco o nero  
raggrinzante. Diffusore in policarbonato.  
Rosone in metallo verniciato bianco o nero raggrinzante.

Body in polished or wrinkle effect white or black painted  
aluminium. Polycarbonate diffuser. Ceiling rose in wrinkle  
effect white or black painted metal.





**Halfpipe 2\_P** | 220-240 V | topLED 25 W DC - 28 W AC

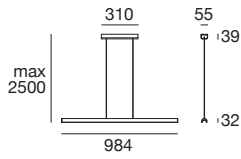

Product	Cct	Cri	lm S	lm D	Optics
9809	3000	90	3525	1912	Diffused
9810					
9811					

Accessory	Description
KIT0026	Phase-cut dimmer (max. 100 W)

**Halfpipe 2\_P** | 220-240 V | topLED 38 W DC - 42 W AC

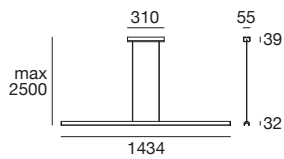

Product	Cct	Cri	lm S	lm D	Optics
9812	3000	90	5042	2539	Diffused
9813					
9814					

Accessory	Description
KIT0026	Phase-cut dimmer (max. 100 W)



**Finishes**

White    Black    Polished Aluminium

# Horizon



174

Disco riflettente in vetro serigrafato/sabbiato.  
Cupola inferiore in metallo nelle finiture galvaniche  
oro o cromo, oppure verniciato bianco raggrinzante.  
Rosone in metallo verniciato bianco raggrinzante.

Reflective disc in silk-screened/sandblasted  
glass. Lower metal dome in gold or chrome  
galvanic finishes or wrinkle effect white painted.  
Ceiling rose in wrinkle effect white painted metal.



**Horizon\_P** | 220-240 V | topLED 29 W DC - 34 W AC



2,5 m

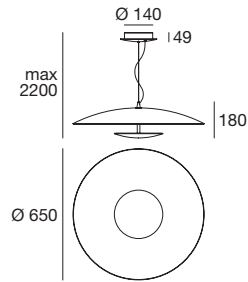

Product	Cct	Cri	lm S	lm D	Optics
90286	3000	80	3652	2270	Diffused
90287					
90288					

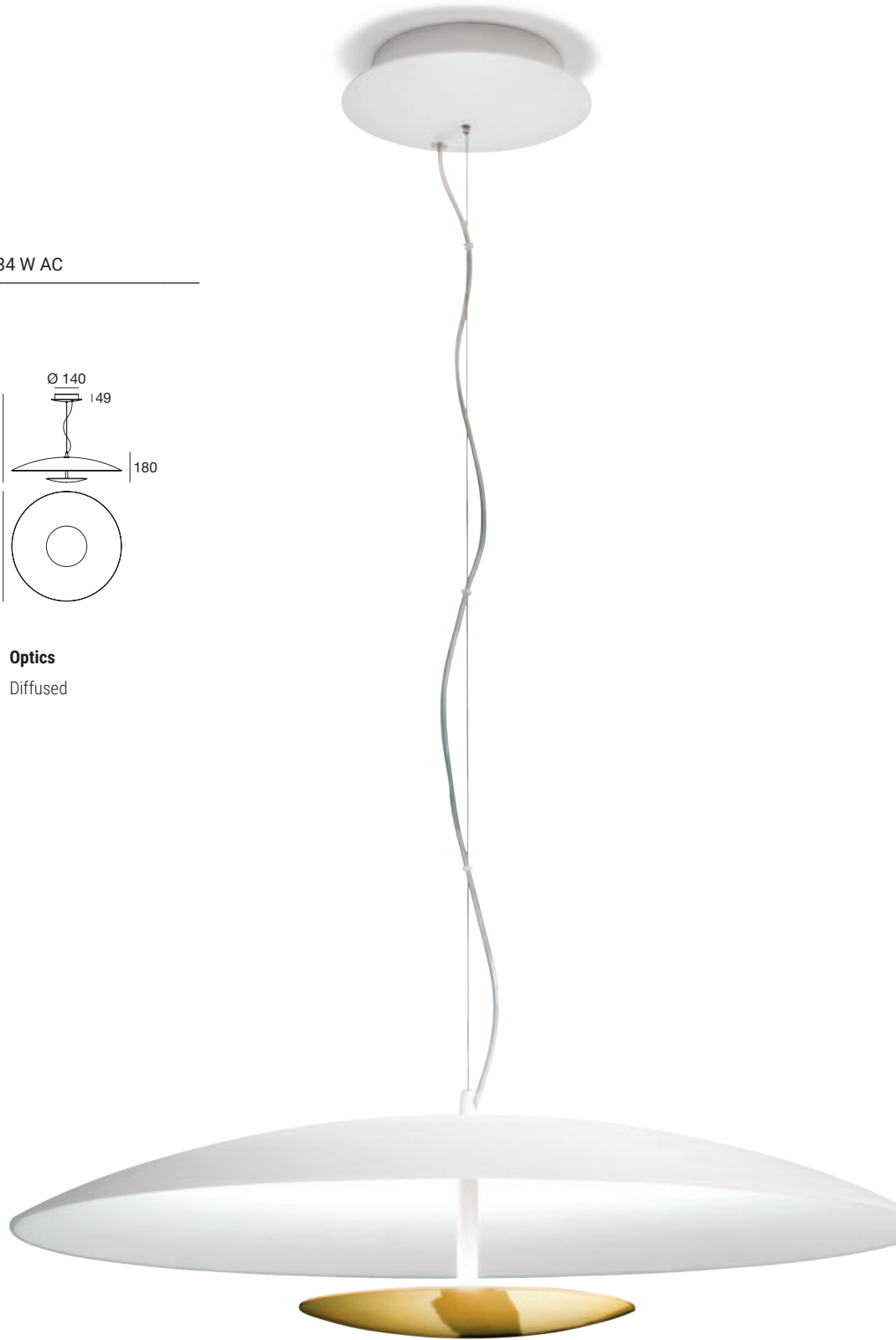

**Finishes**

White   White / Gold   White / Chrome

# Miguel

Corpo in metallo verniciato bicolore: interno bianco, esterno in varie finiture. Rosone in metallo verniciato bianco raggrinzante con cavo di alimentazione bianco, eccetto la versione nera che presenta rosone e cavo neri.

Two-tone painted metal body: white interior, exterior in various finishes. Ceiling rose in wrinkle effect white painted metal with white power cable, except for the black version which has a black ceiling rose and cable.



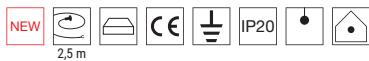

2,5 m

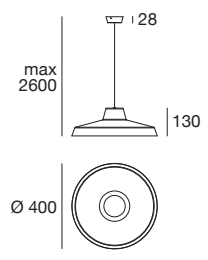

Product	Cct	Cri	lm S	lm D	Optics
9124M	2700	80	1337	953	Diffused
9125M					
9126M					
9127M					
9128M					
9129M					
9124	3000	80	1449	973	Diffused
9125					
9126					
9127					
9128					
9129					



Tutte tranne la versione nera  
All but black version



Solo versione nera  
Only black version



Finishes

- White
- Light Grey
- Azure Blue
- Opal Green
- Vermilion Red
- Black

# Minion



188

Corpo in alluminio verniciato bianco o nero raggrinzante. Diffusore in polimetilmetacrilato trasparente. Rosone in metallo verniciato bianco o nero raggrinzante.

Body in white or black wrinkle effect painted aluminium. Transparent polymethylmethacrylate diffuser. Ceiling rose in wrinkle effect white or black painted metal.



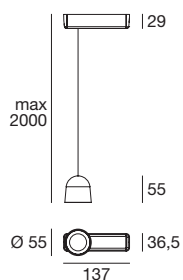

Product	Cct	Cri	Im S	Im D	Optics
<b>8784</b>	3000	90	610	554	Spot (21°)
<b>8786</b>					
<b>8780</b>	3000	90	610	508	M.W.Flood (47°)
<b>8782</b>					



Anelli bianco e rame inclusi con codici: 8784, 8780.

White and copper rings included with codes: 8784, 8780.



Anelli nero e oro inclusi con codici: 8786, 8782.

Black and gold rings included with codes: 8786, 8782.



Luminous flux spot optics

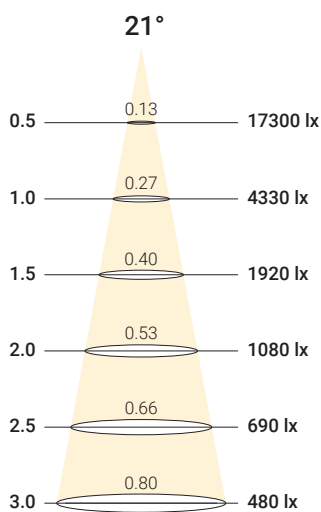

Luminous flux spot optics

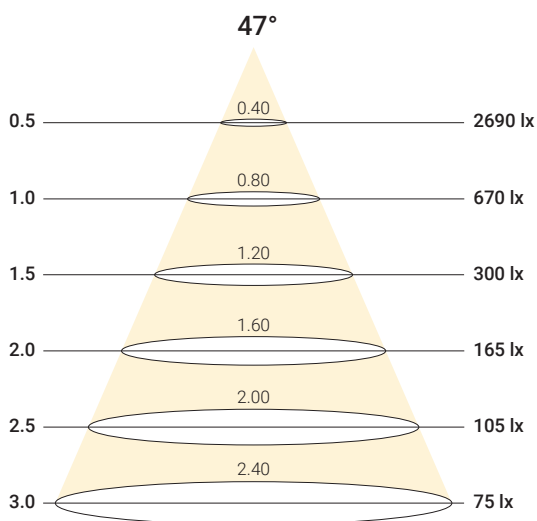

Finishes

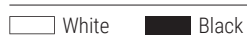

# Oh!



Diffusore in polietilene. Rosone in metallo verniciato bianco raggrinzante.

Polyethylene diffuser. Ceiling rose in wrinkle effect white painted metal.





**Oh!\_P LED** | 220-240 V | arrayLED 6 W DC - 6 W AC

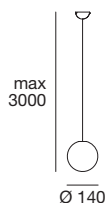
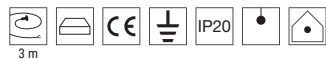

Product	Cct	Cri	Im S	Im D	Optics
10114	3000	80	836	625	Diffused

**Oh!\_P LED** | 220-240 V | topLED 7 W DC - 8 W AC

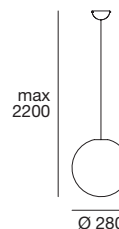

Product	Cct	Cri	Im S	Im D	Optics
12135	3000	80	1022	845	Diffused

**Oh!\_P LED** | 220-240 V | topLED 13 W DC - 15 W AC

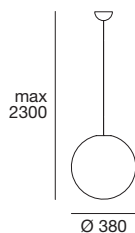

Product	Cct	Cri	Im S	Im D	Optics
12136	3000	80	1930	1584	Diffused

**Oh!\_P LED** | 220-240 V | topLED 18 W DC - 20 W AC

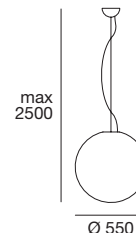

Product	Cct	Cri	Im S	Im D	Optics
12137	3000	80	2748	2115	Diffused

**Oh!\_P LED** | 220-240 V | topLED 26 W DC - 27 W AC

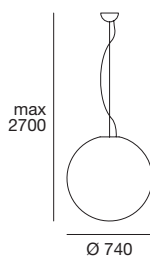

Product	Cct	Cri	Im S	Im D	Optics
12138	3000	80	3835	2856	Diffused

**Finishes**

White

Oh!\_P E27 | 220-240 V

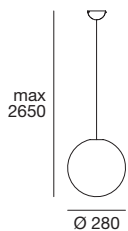

Product	Source
□ 12101	E27 1 x 30 W Max Halogen (LED bulbs compatible)

Oh!\_P E27 | 220-240 V

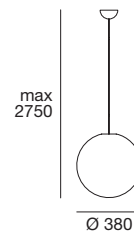
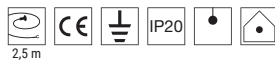

Product	Source
□ 12103	E27 1 x 46 W Max Halogen (LED bulbs compatible)

Oh!\_P E27 | 220-240 V

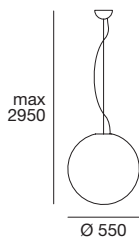

Product	Source
□ 12105	E27 1 x 46 W Max Halogen (LED bulbs compatible)

Oh!\_P E27 | 220-240 V

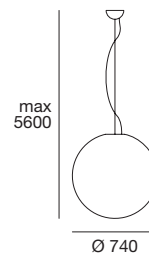

Product	Source
□ 12107	E27 1 x 57 W Max Halogen (LED bulbs compatible)

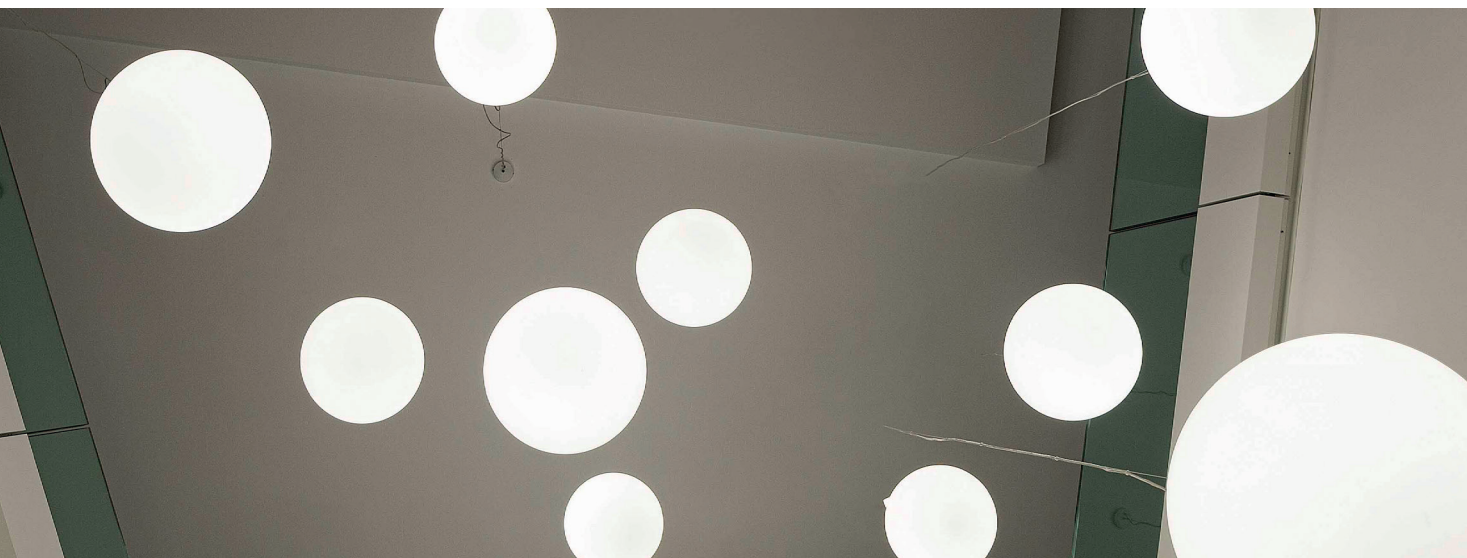

Oh!\_PM3 E27 | 220-240 V

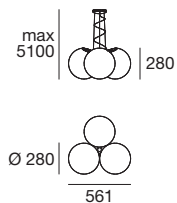

Product	Source
□ 12220	E27 3 x 30 W Max Halogen (LED bulbs compatible)

Oh!\_PM3 E27 | 220-240 V

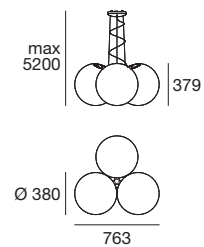

Product	Source
□ 12221	E27 3 x 46 W Max Halogen (LED bulbs compatible)

Oh!\_PM7 E27 | 220-240 V

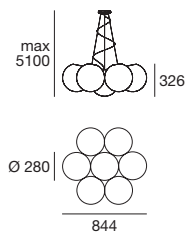

Product	Source
□ 12224	E27 7 x 30 W Max Halogen (LED bulbs compatible)

Oh!\_PM7 E27 | 220-240 V

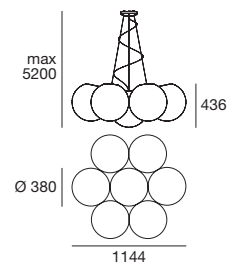

Product	Source
□ 12225	E27 7 x 46 W Max Halogen (LED bulbs compatible)

# Oh! Smash

Diffusore in polietilene. Rosone in metallo verniciato bianco raggrinzante.

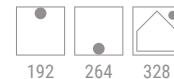

## Oh! Smash\_P E27 | 220-240 V

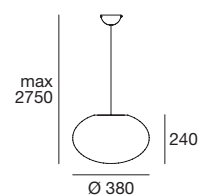

### Product Source

12213	E27 1 x 30 W Max Halogen (LED bulbs compatible)
-------	---

## Oh! Smash\_P E27 | 220-240 V

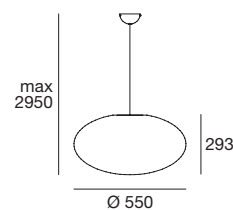

### Product Source

12216	E27 1 x 46 W Max Halogen (LED bulbs compatible)
-------	---

# Ohps

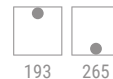

Diffusore in polietilene. Rosone in metallo verniciato bianco raggrinzante.

Polyethylene diffuser. Ceiling rose in wrinkle effect white painted metal.

## Ohps\_P E27 | 220-240 V



2,3 m

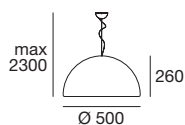

### Product Source

<input type="checkbox"/>	<b>10382</b>	E27 1 x 46 W Max Halogen (LED bulbs compatible)
--------------------------	--------------	---

## Ohps\_P E27 | 220-240 V



2,3 m

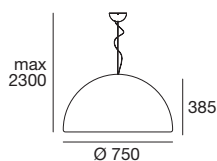

### Product Source

<input type="checkbox"/>	<b>10383</b>	E27 1 x 46 W Max Halogen (LED bulbs compatible)
--------------------------	--------------	---



### Finishes

White

### Pendant luminaires

# Outlook

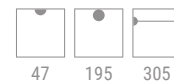

Corpo in alluminio verniciato bianco raggrinzante.  
Diffusore in vetro trasparente. Rosone in metallo  
verniciato bianco raggrinzante.

Body in wrinkle effect white painted aluminium.  
Diffuser in clear glass. Ceiling rose in wrinkle  
effect white painted metal.



Outlook\_P | 220-240 V | arrayLED 8 W DC - 11 W AC



2,1 m

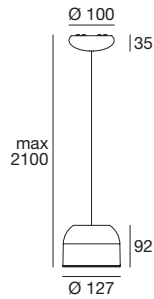

Product	Cct	Cri	lm S	lm D	Optics
8420	3000	90	1082	820	W.Flood (62°)

## Tanta tanta luce!

Il diffusore in vetro con lente integrata amplifica il fascio luminoso, donandoti tutta la luce di cui hai bisogno per un'ottima illuminazione... e anche di più!

## So much light.

The glass diffuser with integrated lens amplifies the light beam, providing all the light needed for optimum illumination ... and more!

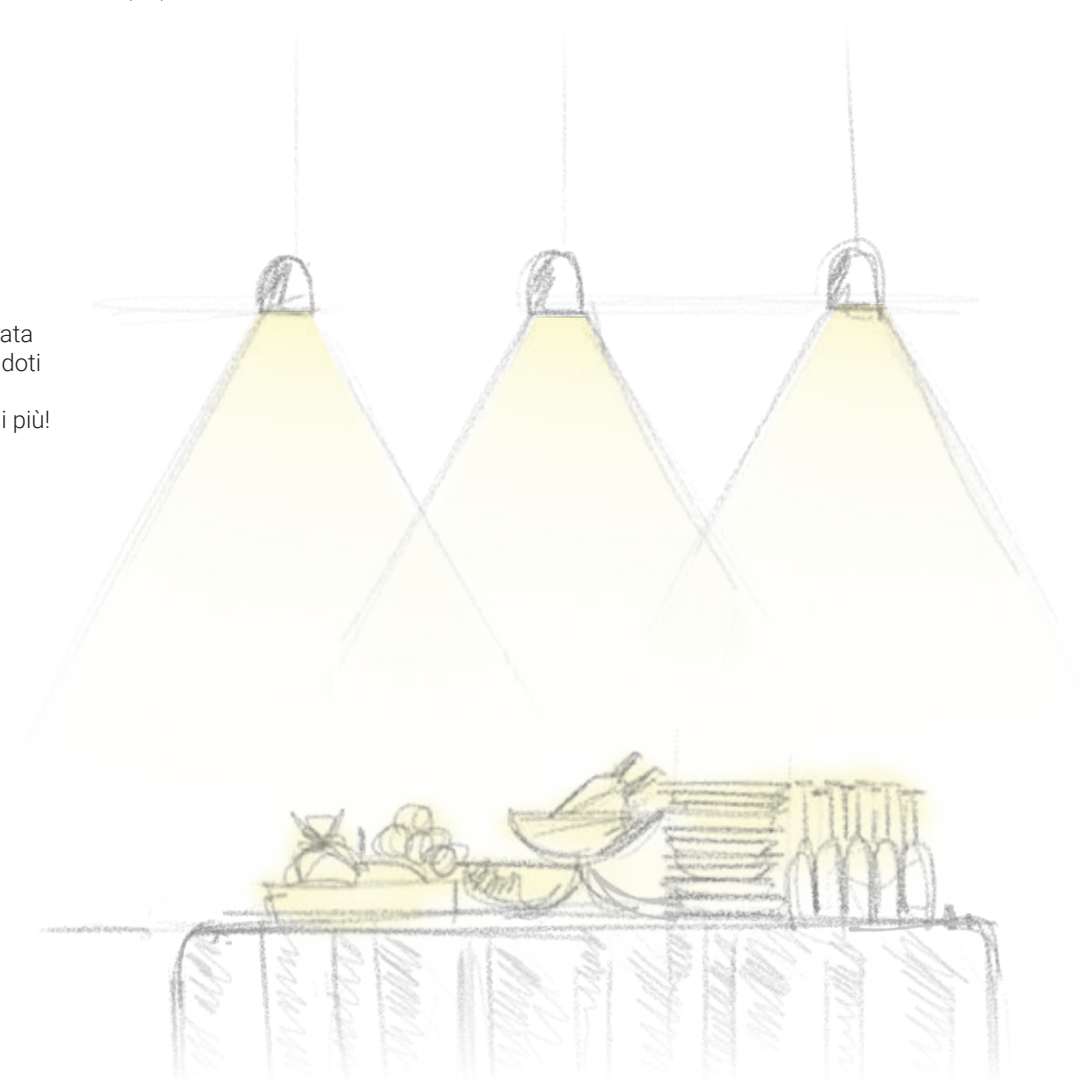

### Finishes

White

Pendant luminaires

# Perla

Corpo centrale in alluminio verniciato bianco o nero raggrinzante. Cilindri esterni in alluminio nelle finiture galvaniche nichel nero spazzolato e oro spazzolato. Diffusori in polimetilmetacrilato sabbato.

Central body in white or black wrinkle effect painted aluminium. External cylinders in aluminium in brushed black nickel and brushed gold galvanic finishes. Diffusers in sandblasted polymethylmethacrylate.





## Due forme e tante soluzioni!

Il modello da 9 bracci complessivi contiene una sezione da 6 e una da 3, combinabili in due diverse configurazioni. Il modello da 12 bracci complessivi contiene una sezione da 6 e due da 3, combinabili in tre diverse configurazioni.

## Two forms, many solutions.

The 9-arm model features one section of 6 and another of 3 arms that can be combined in two different configurations.

The 12-arm model features one section of 6 and another two sections of 3 arms that can be combined in three different configurations.

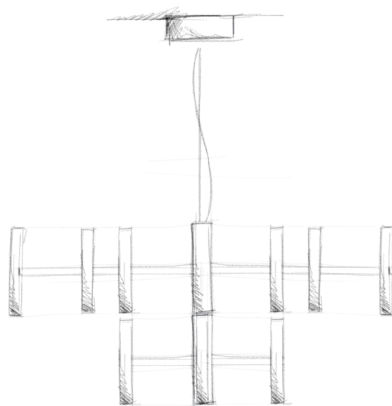

6+3 Up

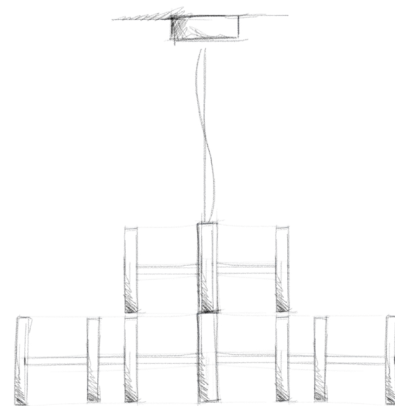

6+3 Down

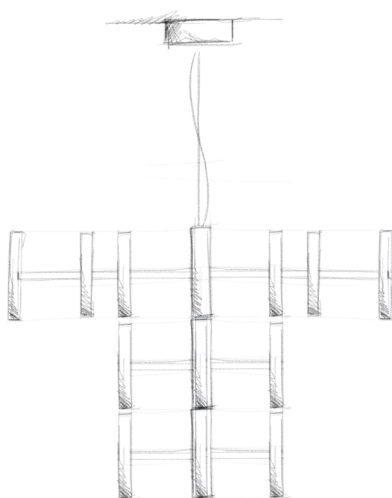

6+3+3 Up

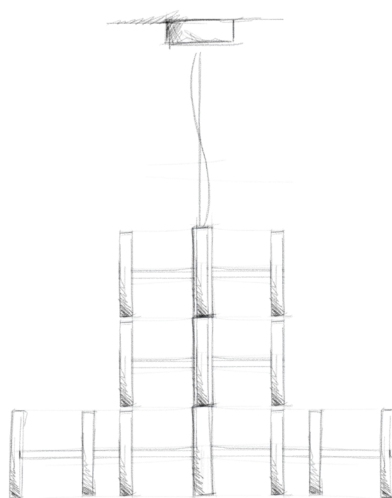

6+3+3 Down

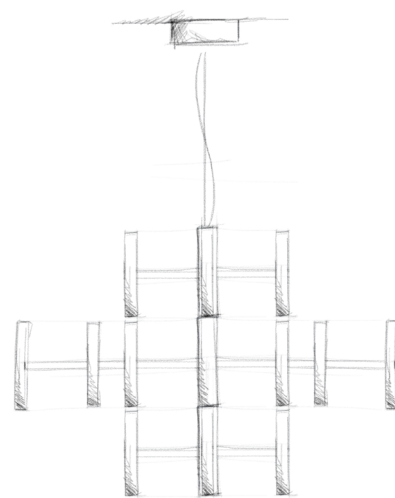

3+6+3 Central

## Semplicemente innestabile, ed è subito chandelier!

Un disco filettato unisce le estremità del corpo centrale grazie ad un avvitamento intuitivo. Puoi scegliere come posizionare le sezioni, come nei classici chandelier: preferisci 6 bracci sopra e 3 sotto o viceversa? Oppure 3+6+3? O magari 3+3+6?

## Simply insert to become a chandelier in an instant.

A threaded disc connects the ends of the central body by means of intuitive screwing. You can choose how to position the sections, just like in classic chandeliers – do you prefer 6 arms above and 3 below or vice versa? Or even 3 + 6 + 3? Or perhaps 3 + 3 + 6?

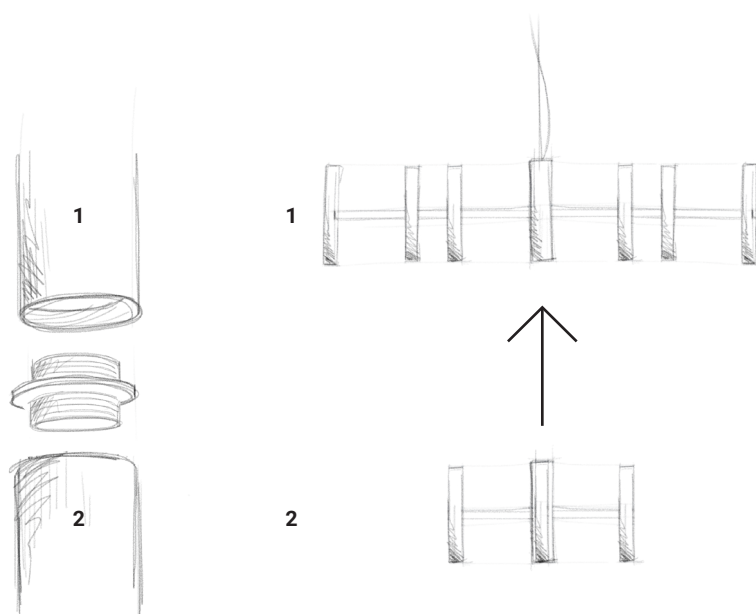



Perla\_P9 | 200-240 V | topLED 37 W DC - 40 W AC

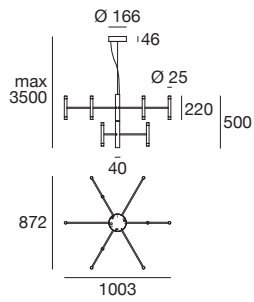

Product	Cct	Cri	lm S	lm D	Optics
■ 9750	3000	90	5576	3864	Diffused
■ 9751					
■ 9752					
■ 9753					

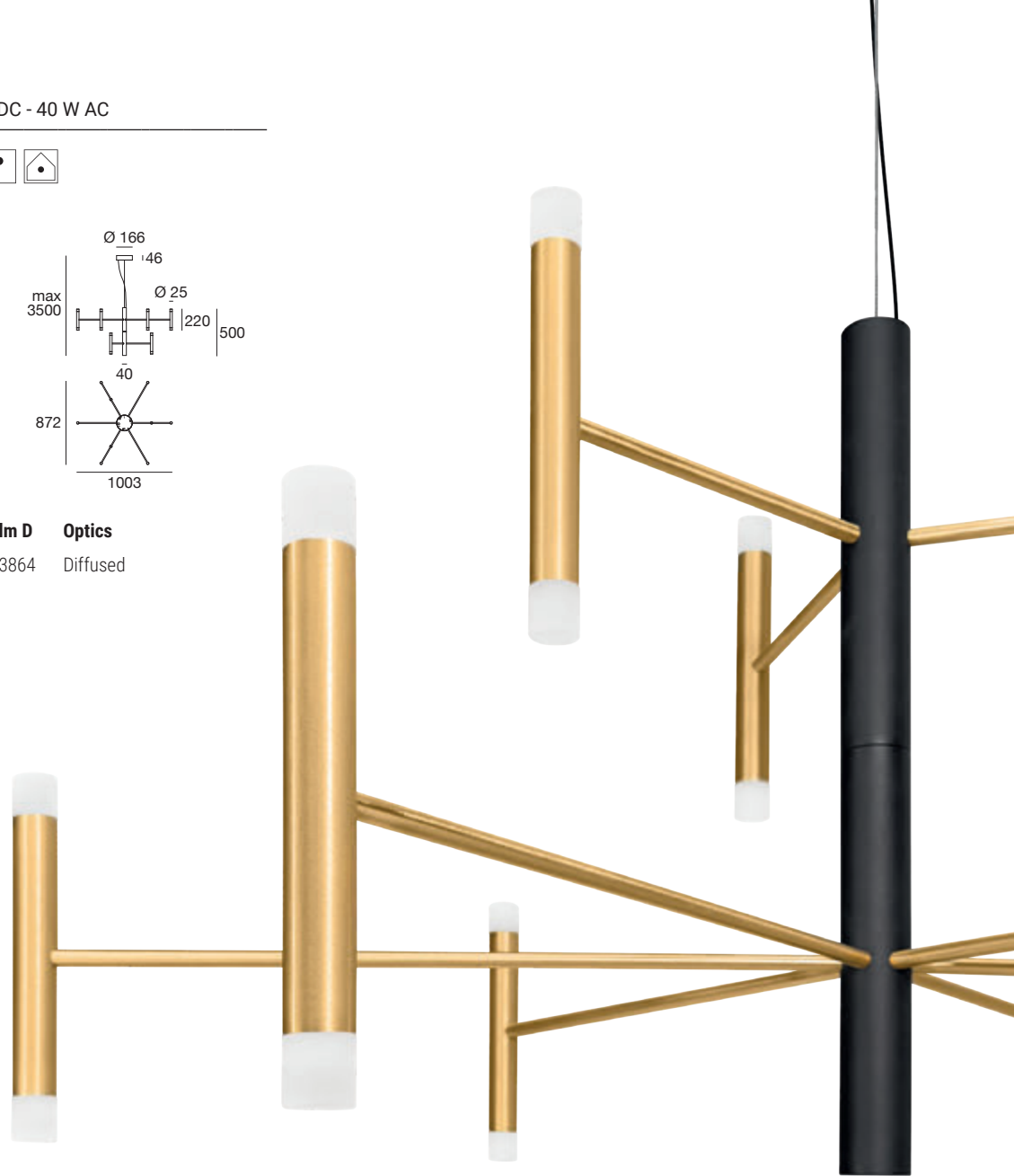

Perla\_P12 | 200-240 V | topLED 53 W DC - 59 W AC

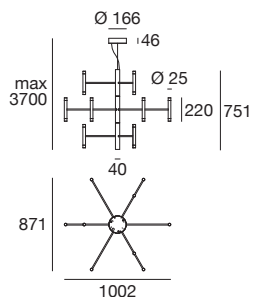

Product	Cct	Cri	lm S	lm D	Optics
■ 9755	3000	90	8110	5644	Diffused
■ 9756					
■ 9757					
■ 9758					

Finishes

- Brushed Black Nickel / White
- Brushed Black Nickel / Black
- Brushed Gold / White
- Brushed Gold / Black

Pendant luminaires

# Poe

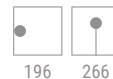

196 266

Corpo in metallo verniciato bianco, nero o grigio raggrinzante, oppure in finitura terracotta. Diffusore in policarbonato satinato. Il rosone in metallo riprende la stessa finitura del corpo lampada.

Body in white, black or wrinkle effect grey painted metal or in terracotta finish. Satin polycarbonate diffuser. The metal ceiling rose is in the same finish as the light body.



Poe\_P1 | 220-240 V | topLED 6 W DC - 7 W AC

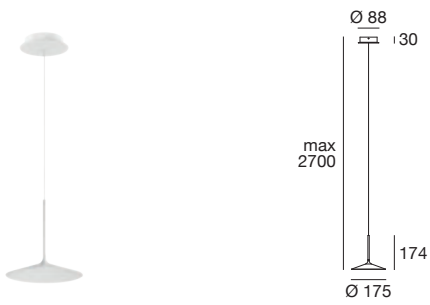
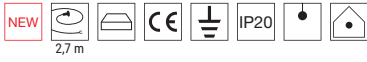

Product	Cct	Cri	lm S	lm D	Optics
8350	3000	90	739	600	Diffused
8351					
8353					
8354					

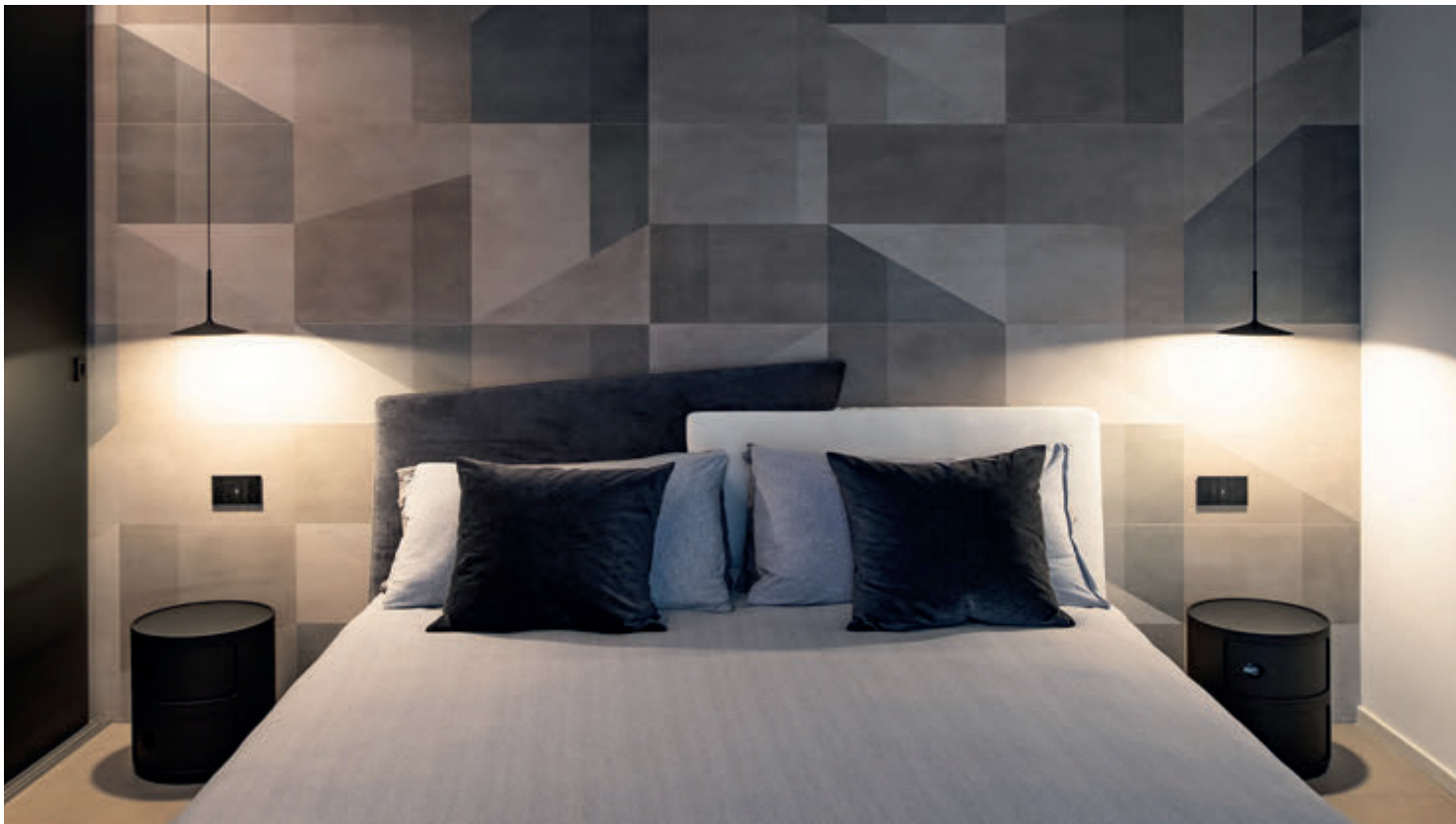

Finishes

- White
- Black
- Basalt Grey
- Terracotta

Pendant luminaires



**Poe\_P3** | 220-240 V | topLED 17 W DC - 19 W AC

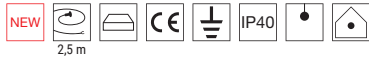

2,5 m

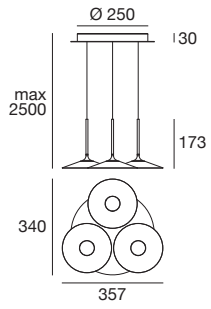
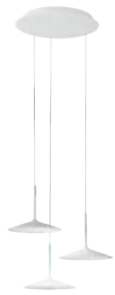

Product	Cct	Cri	lm S	lm D	Optics
8355	3000	90	2113	1800	Diffused
8356					
8358					
8359					

**Poe\_Plus** | 220-240 V | topLED 12 W DC - 15 W AC

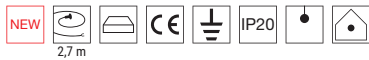

2,7 m

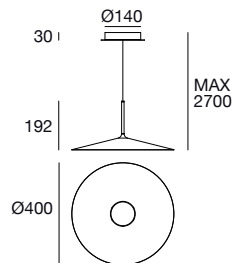

Product	Cct	Cri	lm S	lm D	Optics
8360	3000	90	1623	1484	Diffused
8361					
8363					
8364					

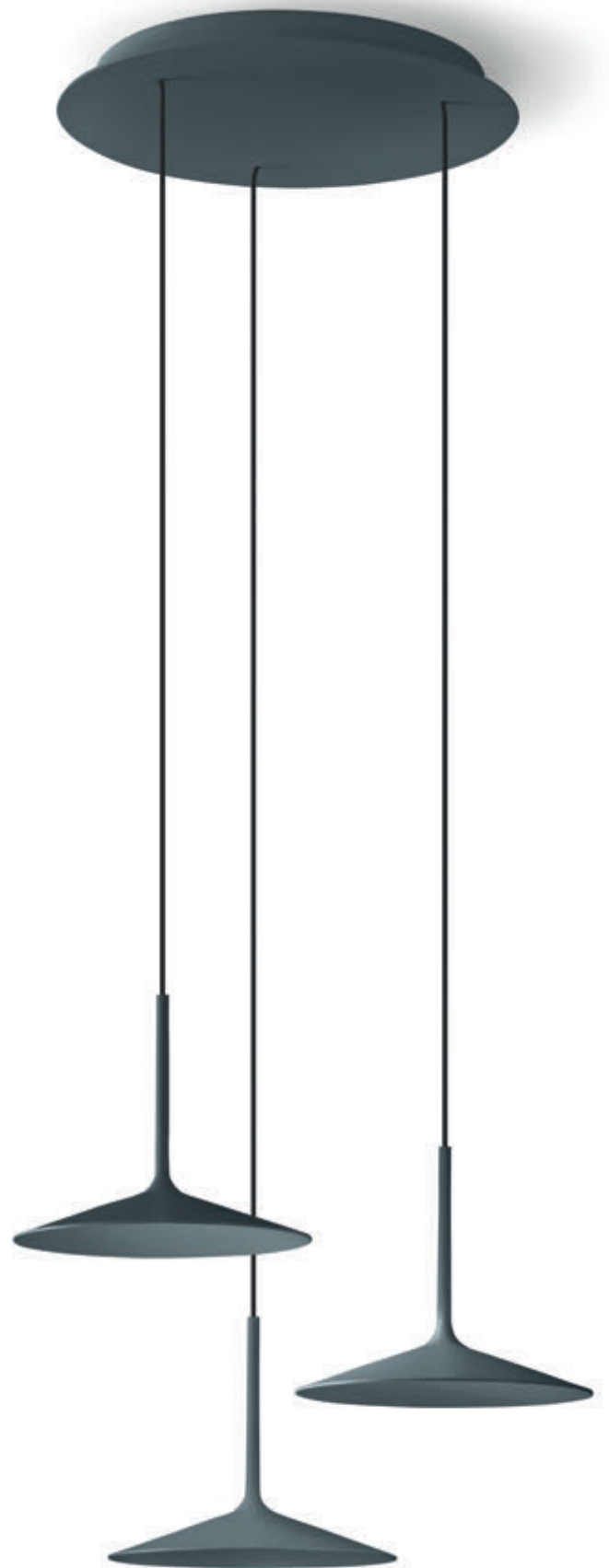

**Finishes**



# Polo



Diffusore in polietilene. Rosone in metallo verniciato bianco raggrinzante.

Polyethylene diffuser. Ceiling rose in wrinkle effect white painted metal.



## Polo\_P | 220-240 V | topLED 27 W DC - 31 W AC

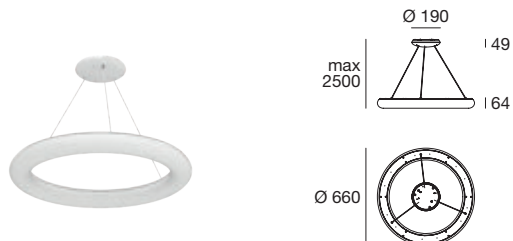

### ON/OFF

Product	Cct	Cri	lm S	lm D	Optics
9162	3000	80	3568	3222	Diffused

### DALI

Product	Cct	Cri	lm S	lm D	Optics
9164	3000	80	3568	3222	Diffused

## Polo\_P | 220-240 V | topLED 45 W DC - 51 W AC

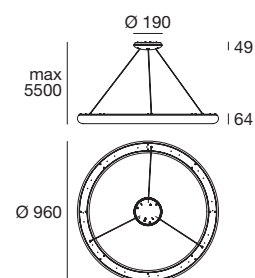

### ON/OFF

Product	Cct	Cri	lm S	lm D	Optics
9163	3000	80	5966	5118	Diffused

### DALI

Product	Cct	Cri	lm S	lm D	Optics
9165	3000	80	3568	3222	Diffused



# Rose



204

Diffusore in polietilene. Rosone in metallo verniciato bianco raggrinzante.

Polyethylene diffuser. Ceiling rose in wrinkle effect white painted metal.

**Rose\_P** | 220-240 V | E27



2,5 m

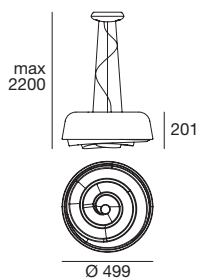

**Product**    **Source**

<input type="checkbox"/> 7655	E27 2 x 46 W Max Halogen (LED bulbs compatible)
-------------------------------	---

**Rose\_P** | 220-240 V | E27



2,5 m

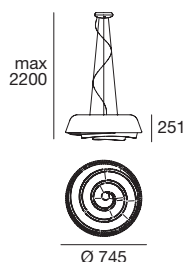

**Product**    **Source**

<input type="checkbox"/> 7657	E27 3 x 46 W Max Halogen (LED bulbs compatible)
-------------------------------	---



**Finishes**

White

**Pendant luminaires**

# Satori

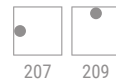

Corpo in alluminio verniciato bianco o nero raggrinzante.  
Diffusore in policarbonato opalino. Rosone in metallo  
verniciato bianco o nero raggrinzante.

Body in white or black wrinkle effect painted aluminium.  
Opal polycarbonate diffuser. Ceiling rose in wrinkle  
effect white or black painted metal.



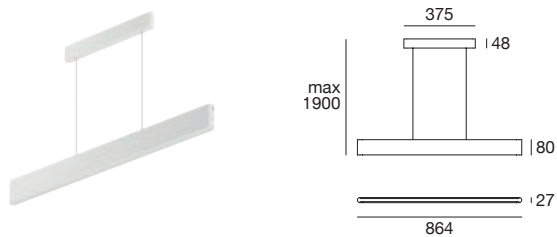

Product	Cct	Cri	lm S	lm D	Optics
9195M	2700	90	4218	2360	Diffused
9196M					
9195	3000	90	4462	2502	Diffused
9196					

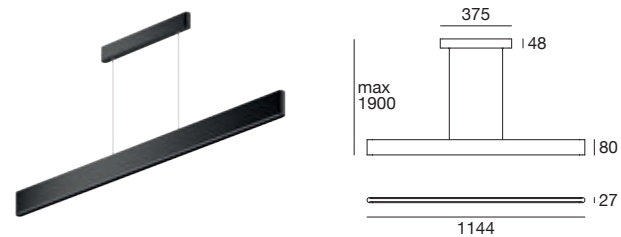

Product	Cct	Cri	lm S	lm D	Optics
9197M	2700	90	5624	3706	Diffused
9198M					
9197	3000	90	5950	3929	Diffused
9198					

### Luce, performance e design.

Luce diretta e indiretta, alte prestazioni e controllo del glaring grazie al diffusore recesso si combinano con una forma familiare orientata al design, spesso appena 27 millimetri, con angoli arrotondati e senza tappi di chiusura per una perfetta continuità estetica.

### Light, effectiveness and design.

Direct and indirect light, high output and glare control thanks to the recessed diffuser combined with a familiar design-oriented form, at just 27 millimetre thick, featuring rounded corners and no end caps for perfect aesthetic continuity.

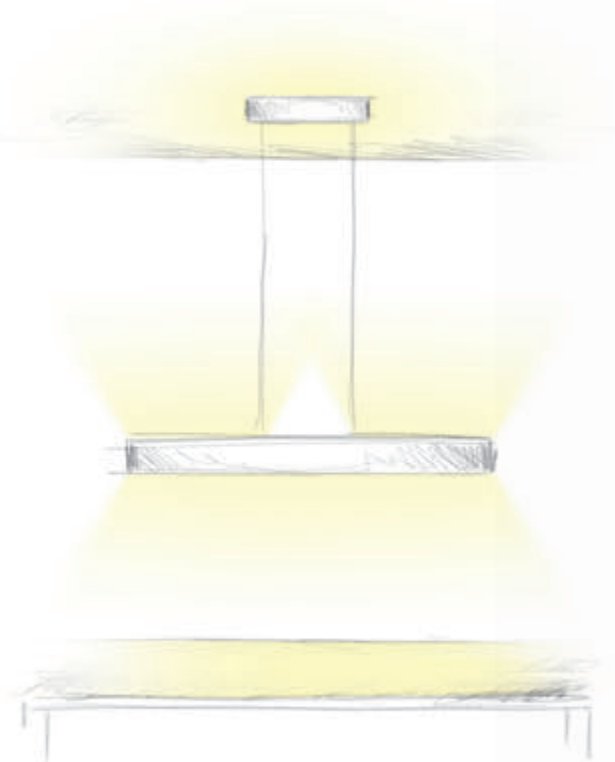

SCALE 1:1  
Only 2,7 cm



#### Finishes

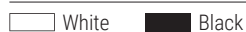





# Sinfonia

SYS  
TEM  
282

Corpo in alluminio verniciato bianco o nero raggrinzante, oppure nelle finiture galvaniche cromo e oro spazzolato. Diffusore in polimetilmetacrilato. Il rosone in metallo riprende la stessa finitura del corpo lampada.

Body in wrinkle effect white or black painted aluminium, or in the galvanic chrome and brushed gold finishes. Diffuser in polymethylmethacrylate. The metal ceiling rose is in the same finish as the light body.



**Puccini** | 220-240 V | topLED 2 W DC - 3 W AC

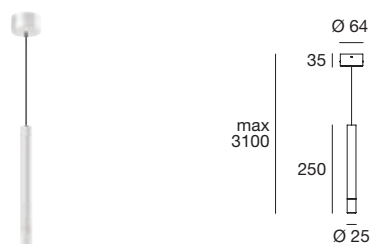

Product	Cct	Cri	Im S	Im D	Optics
9250	3000	90	221	147	Diffused
9251					
9252					
9254					

**Puccini** | 220-240 V | topLED 2 W DC - 3 W AC

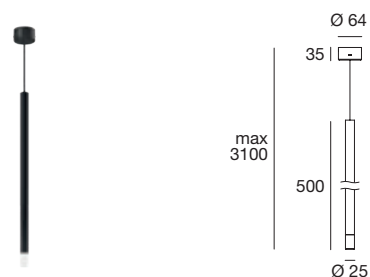

Product	Cct	Cri	Im S	Im D	Optics
9255	3000	90	221	147	Diffused
9256					
9257					
9259					

**Puccini** | 220-240 V | topLED 4 W DC - 5 W AC

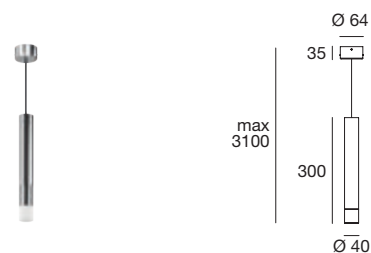

Product	Cct	Cri	Im S	Im D	Optics
9260	3000	90	484	331	Diffused
9261					
9262					
9264					

**Puccini** | 220-240 V | topLED 4 W DC - 5 W AC

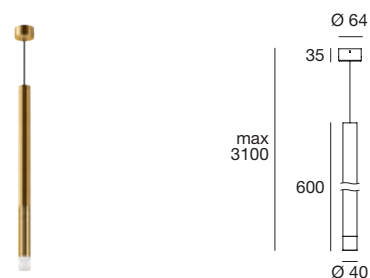

Product	Cct	Cri	Im S	Im D	Optics
9265	3000	90	484	331	Diffused
9266					
9267					
9269					

**Puccini** | 220-240 V | topLED 8 W DC - 9 W AC

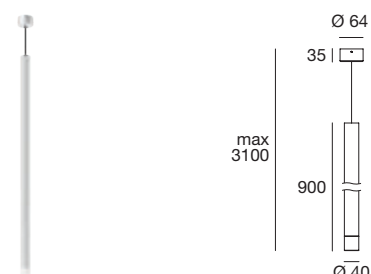

Product	Cct	Cri	Im S	Im D	Optics
9270	3000	90	730	560	Diffused
9271					
9272					
9274					

**Finishes**

- White
- Black
- Chrome
- Brushed Gold

**Pendant luminaires**





**Rossini\_P** | 220-240 V | topLED 5 W DC - 7 W AC

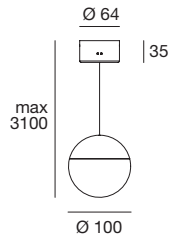

Product	Cct	Cri	lm S	lm D	Optics
□ 9225	3000	90	627	468	Diffused
■ 9226					
▨ 9227					
■ 9229					

**Verdi** | 220-240 V | topLED 5 W DC - 6,5 W AC

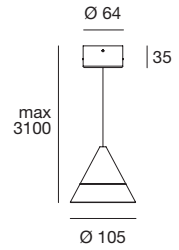

Product	Cct	Cri	lm S	lm D	Optics
□ 9230	3000	90	627	393	Diffused
■ 9231					
▨ 9232					
■ 9234					

**Vivaldi\_P1** | 220-240 V | topLED 5 W DC - 6 W AC

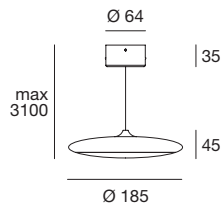

Product	Cct	Cri	lm S	lm D	Optics
□ 9240	3000	90	523	299	Diffused
■ 9241					
▨ 9242					
■ 9244					

**Vivaldi\_P3** | 220-240 V | topLED 15 W DC - 17 W AC

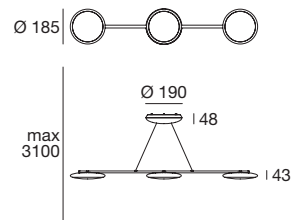

Product	Cct	Cri	lm S	lm D	Optics
□ 9245	3000	90	1569	1016	Diffused
■ 9246					
▨ 9247					
■ 9249					

**Finishes**

□ White   ■ Black   ▨ Chrome   ■ Brushed Gold

**Pendant luminaires**

# Squash

Diffusore in polietilene. Rosone in metallo verniciato bianco raggrinzante.

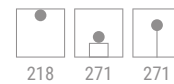

Polyethylene diffuser. Ceiling rose in wrinkle effect white painted metal.



**Squash\_P** | 220-240 V | topLED 9 W AC

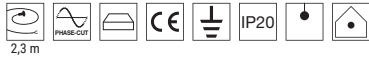

2,3 m

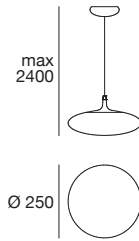

Product	Cct	Cri	lm S	lm D	Optics
<input type="checkbox"/> 7948	3000	90	870	830	Diffused

**Accessory Description**

**KIT0026** | Phase-cut dimmer (max. 100 W)

**Squash\_P** | 220-240 V | topLED 19 W AC



2,3 m

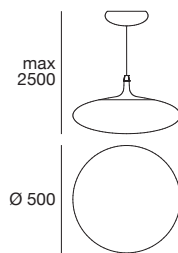

Product	Cct	Cri	lm S	lm D	Optics
<input type="checkbox"/> 7627	3000	90	2364	1750	Diffused



**Finishes**

White

# Straight

Corpo in alluminio verniciato bianco o nero raggrinzante, oppure in finitura galvanica cromo. Diffusore in policarbonato opalino. Rosone in metallo verniciato bianco o nero raggrinzante.

Body in wrinkle effect white or black painted aluminium or in galvanic chrome finish. Opal polycarbonate diffuser. Ceiling rose in wrinkle effect white or black painted metal.



## Emissione diffusa o recessa, il bello di poter scegliere quando vuoi.

Ebbene sì, il diffusore è estraibile e riposizionabile nel corpo lampada. Quindi puoi scegliere quando vuoi tra due tipi di emissione: diffusa oppure recessa.

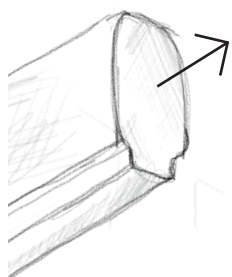

Togli il tappo svitando la piccola vite di bloccaggio con la brugola in dotazione.

Remove the cap by unscrewing the small locking screw with the allen key provided.

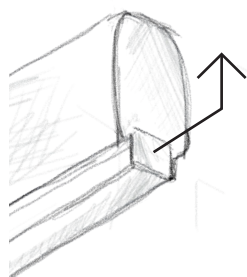

Estrai il diffusore dall'alloggiamento inferiore tirando delicatamente verso l'esterno.

Extract the diffuser out of the lower housing by gently pulling outwards.

## Diffuse or recessed emission, the beauty of being able to choose when you want.

The diffuser is even removable and repositionable within the lamp body so you can choose between two types of emission – diffuse or recessed – whenever you want.

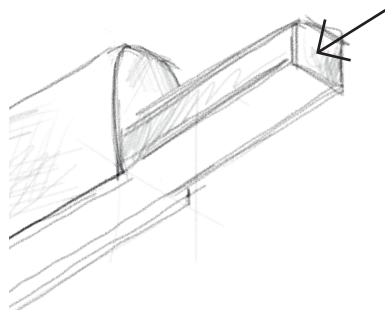

Inserisci il diffusore nell'alloggiamento superiore, spingendo delicatamente.

Insert the diffuser into the upper housing, pushing in gently.

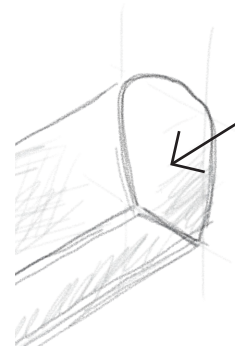

Utilizza l'apposito tappo di chiusura per configurazione recessa, incluso nella confezione.

Use the dedicated end cap for recessed configuration, included in the package.

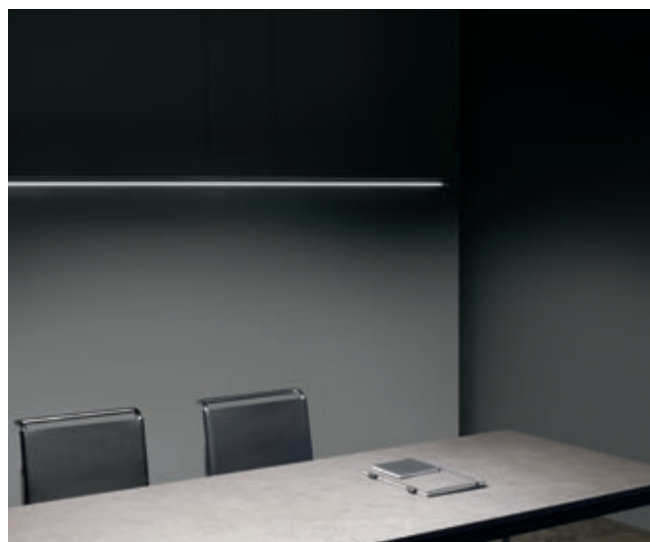

Diffused emission (End-caps Included)

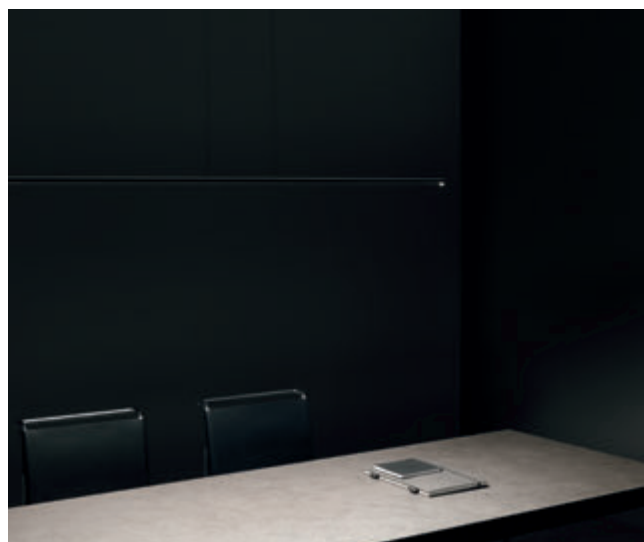

Recessed emission (End-caps Included)





**Abbassa, alza, inclina e ruota di 20°**  
**Lower, raise, tilt and rotate 20°**

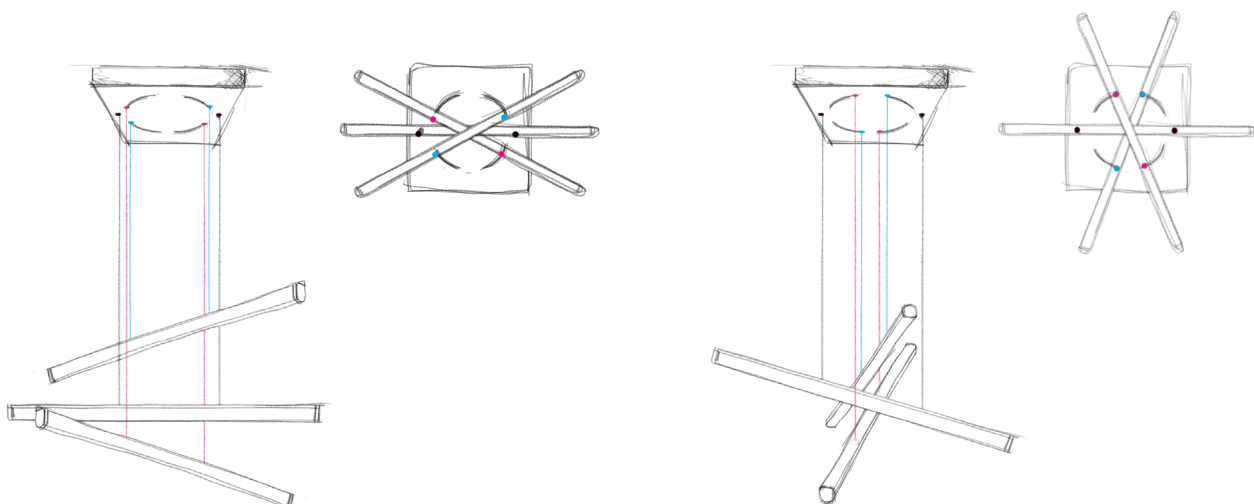

**Straight\_P1** | 220-240 V | topLED 10 W DC - 11 W AC

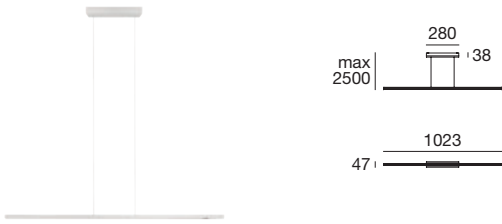

Product	Cct	Cri	Im S	Im D	Optics
□ 8200	2700	90	1442	552	Diffused
■ 8204					
■   ■ 8505					



Hooks for indirect application included

**Straight\_P1** | 220-240 V | topLED 15 W DC - 18 W AC

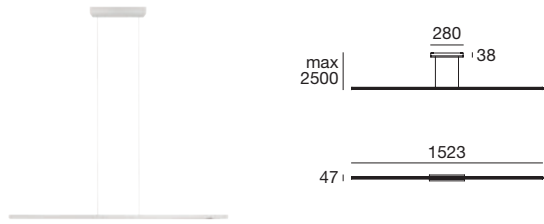

Product	Cct	Cri	Im S	Im D	Optics
□ 8201	2700	90	2222	790	Diffused
■ 8205					
■   ■ 8506					



Hooks for indirect application included

**Straight\_P3** | 220-240 V | topLED 30 W DC - 34 W AC

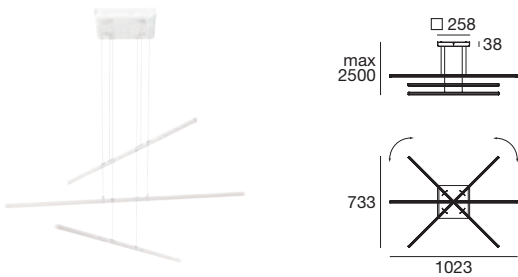

Product	Cct	Cri	Im S	Im D	Optics
□ 8202	2700	90	4445	1571	Diffused
■ 8206					
■   ■ 8507					



Hooks for indirect application included

**Straight\_P3** | 220-240 V | topLED 45 W DC - 49 W AC

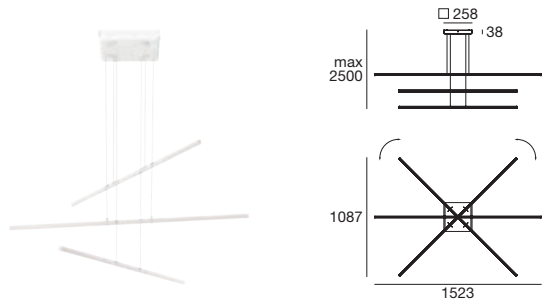

Product	Cct	Cri	Im S	Im D	Optics
□ 8203	2700	90	6668	2348	Diffused
■ 8207					
■   ■ 8508					



Hooks for indirect application included

**Finishes**

□ White   ■ Black   ■ | ■ Chrome

# TU-0

Diffusore in polimetilmetacrilato opalino. Tappi di chiusura in alluminio verniciato bianco raggrinzante. Rosone in metallo verniciato bianco raggrinzante. Kit cover comfort in metallo verniciato nero raggrinzante.

Diffuser in opal polymethylmethacrylate. Closing caps in wrinkle effect white painted aluminium. Ceiling rose in wrinkle effect white painted metal. Comfort cover kit in wrinkle effect black painted metal.





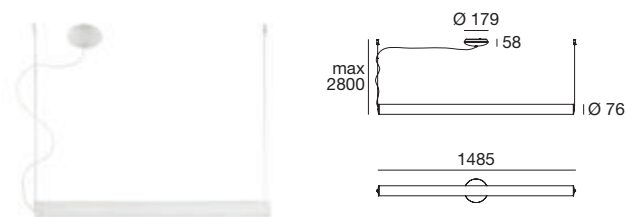
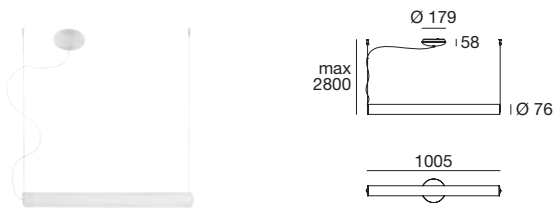
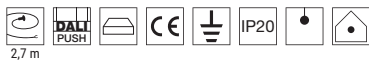

Product	Cct	Cri	lm S	lm D	Optics
8845	3000	80	4828	4199	Diffused

Product	Cct	Cri	lm S	lm D	Optics
8846	3000	80	7242	5818	Diffused

**Accessory Description**

**KIT0112** | Black cover for TU-O L = 1005 mm

**Accessory Description**

**KIT0113** | Black cover for TU-O L = 1485 mm

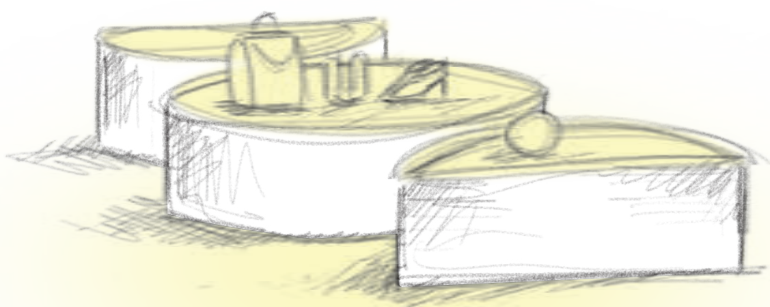
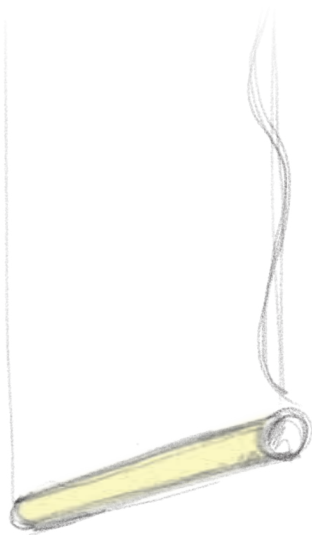

**Finishes**

White

# TU-V



312

Diffusore in polimetilmetacrilato opalino. Tappi di chiusura in alluminio verniciato bianco raggrinzante. Rosone in metallo verniciato bianco raggrinzante.

Diffuser in opal polymethylmethacrylate. Closing caps in wrinkle effect white painted aluminium. Ceiling rose in wrinkle effect white painted metal.



**TU-V** | 220-240 V | topLED 16 W DC - 20 W AC

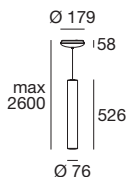

Product	Cct	Cri	lm S	lm D	Optics
8842	3000	80	2414	2343	Diffused

**TU-V** | 220-240 V | topLED 32 W DC - 36 W AC

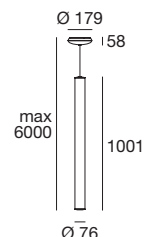

Product	Cct	Cri	lm S	lm D	Optics
8843	3000	80	4828	4199	Diffused

**TU-V** | 220-240 V | topLED 48 W DC - 54 W AC

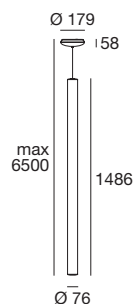

Product	Cct	Cri	lm S	lm D	Optics
8844	3000	80	7242	5996	Diffused

**TU-V** | 220-240 V | topLED 48 W DC - 60 W AC

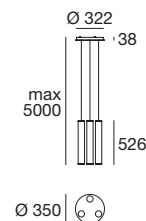

Product	Cct	Cri	lm S	lm D	Optics
8840	3000	80	7242	7029	Diffused

**TU-V** | 220-240 V | topLED 80 W DC - 96 W AC

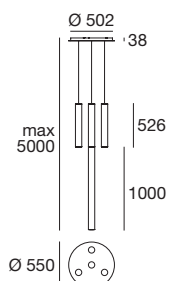

Product	Cct	Cri	lm S	lm D	Optics
8841	3000	80	12070	11228	Diffused

**Finishes**

White





# Yo-yo

234

Corpo in alluminio verniciato raggrinzante in varie finiture.  
Diffusore in polimetilmetacrilato opalino. Il rosone in metallo riprende la stessa finitura del corpo lampada.

Body in wrinkle effect painted aluminium in various finishes.  
Diffuser in opal polymethylmethacrylate. The metal ceiling rose is in the same finish as the light body.



Yo-yo\_P | 220-240 V | topLED 13 W DC - 16 W AC



2,3 m

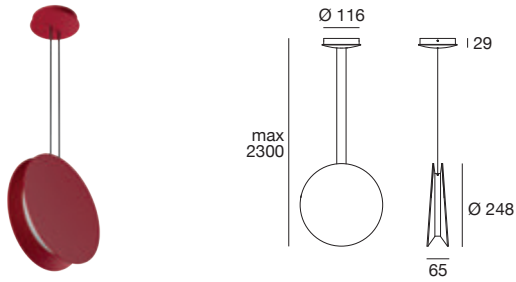

Product	Cct	Cri	lm S	lm D	Optics
9637M	2700	90	1844	1079	Diffused
9638M				396	
9639M				570	
9640M				413	
9637	3000	90	1983	1173	Diffused
9638				430	
9639				620	
9640				449	

**Accessory Description**

**KIT0026** | Phase-cut dimmer (max. 100 W)

**Meravigliosamente asimmetrico.**

Il diffusore di Yo-Yo è schermato da due dischi concavi dalla conformazione obliqua. Il risultato è un'emissione variabile, più aperta sul piano sottostante e più stretta nella parte superiore.

**Fantastically asymmetrical.**

Yo-Yo's diffuser is shielded by two concave discs with an oblique shape. The result is a variable emission, broader at the base and narrower at the top.

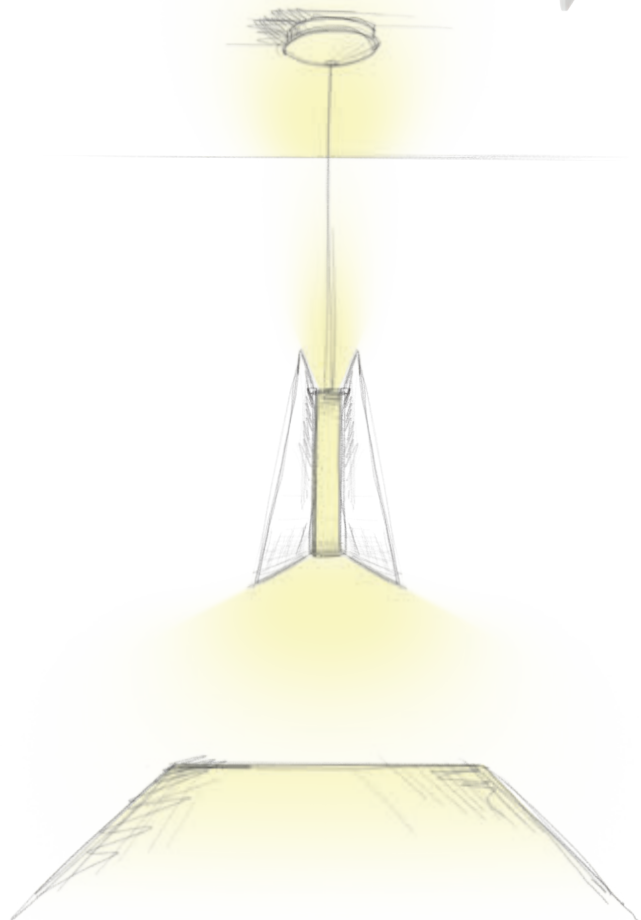

**Finishes**

White    Black    Basalt Grey    Ruby Red

# Zig zag



237

Corpo in alluminio verniciato bianco o nero raggrinzante, oppure in finitura galvanica argento. Diffusore in vetro sabbato. Il rosone in metallo riprende la stessa finitura del corpo lampada.

Body in wrinkle effect white or black painted aluminium or in galvanic silver finish. Sandblasted glass diffuser. The metal ceiling rose has the same finish as the light body.





**Zig zag\_P** | 220-240 V | E27



2,3 m

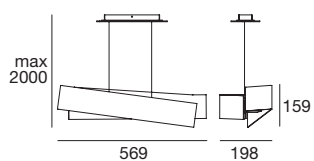

Product	Source
6991	E27
6994	2 x 57 W Max Halogen (LED bulbs compatible)
6995	

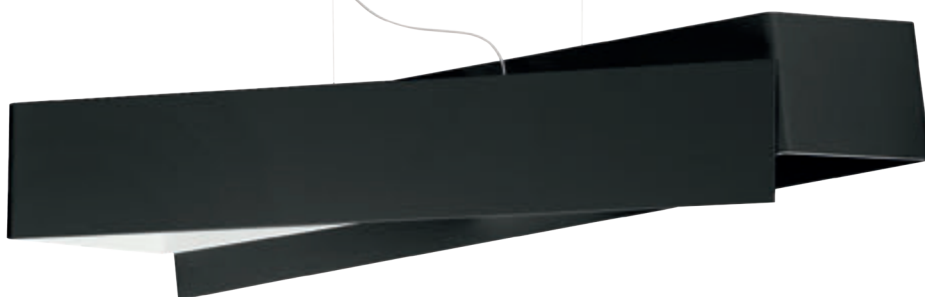

**Finishes**

White   Black / White   Anodised Aluminium





**CEILING  
& WALL**

# Alba



332

Corpo e montatura in alluminio verniciato bianco o nero raggrinzante. Diffusore in vetro trasparente.

Body and mount in white or black wrinkle effect painted aluminium. Diffuser in clear glass.



Alba | 220-240 V | arrayLED 31 W DC - 34 W AC

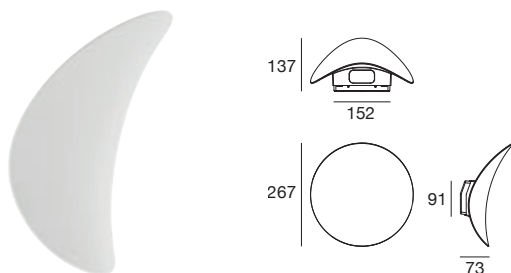
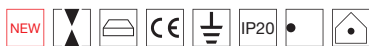

Product	Cct	Cri	lm S	lm D	Optics
9658M	2700	90	2272	2161	Diffused
9659M					
9658	3000	90	2470	2349	Diffused
9659					

## Una lampada, due posizioni, quattro diverse tipologie di luce.

Puoi orientare la lampada e scegliere di avere più luce verso il basso o verso l'alto, grazie alla doppia superficie installativa. Scegli tu come installarla, e se cambi idea... no problem! E non è tutto: ruotandola di 180° avrai due ulteriori tipologie di posizionamento e luce, diverse dalle precedenti.

## One lamp, two positions, four different types of light.

Orient the lamp to have more light shining downwards or upwards, thanks to the dual installation surface. You can even choose how to install this fixture then if you change your mind ... no problem! And that's not all. By rotating the light 180°, you have two further types of positioning and light, differing from the previous ones.

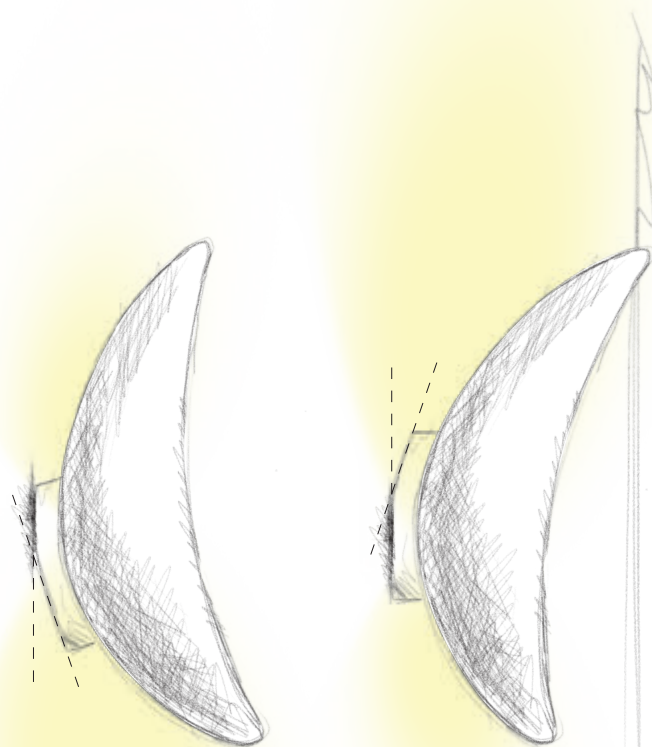

Finishes

White Black

Ceiling & Wall

# Antigua

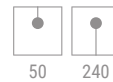

Diffusore in vetro trasparente con bordo sabbia. Elemento centrale e montatura in metallo verniciato bianco raggrinzante.

Diffuser in clear glass with sandblasted edge. Central element and mount in wrinkle effect white painted metal.



**Antigua\_S** | 220-240 V | stripLED 17 W DC - 19 W AC



Product	Cct	Cri	lm S	lm D	Optics
90345	3000	90	2165	1473	Diffused

**Antigua\_S** | 220-240 V | stripLED 35 W DC - 38 W AC

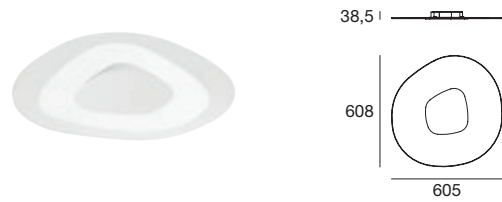

Product	Cct	Cri	lm S	lm D	Optics
90346	3000	90	3996	2945	Diffused

**Antigua\_S** | 220-240 V | stripLED 43 W DC - 46 W AC

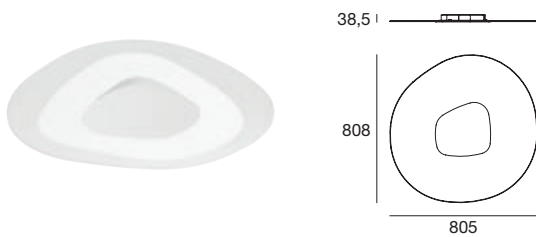
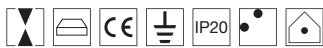

Product	Cct	Cri	lm S	lm D	Optics
90347	3000	90	4596	3760	Diffused

**Finishes**

White

# Antille



51

Diffusore in vetro trasparente con bordo sabbiato asimmetrico. Elemento centrale in metallo nelle finiture galvaniche rame, oro, cromo oppure verniciato bianco raggrinzante. Montatura in metallo verniciato bianco raggrinzante.

Diffuser in clear glass with asymmetrical sandblasted edge. Central element in metal in copper, gold, chrome galvanic finishes or white wrinkle effect finish. Mount in white painted metal with wrinkle effect.





**Antille\_S** | 220-240 V | stripLED 11 W DC - 14 W AC

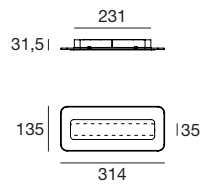

Product	Cct	Cri	lm S	lm D	Optics
8880	3000	90	1640	1457	Diffused
8881					
8882					
8883					

**Antille\_S** | 220-240 V | stripLED 23 W DC - 28 W AC

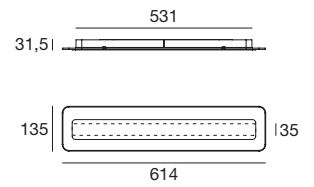

Product	Cct	Cri	lm S	lm D	Optics
8885	3000	90	3363	2912	Diffused
8886					
8887					
8888					

**Asymmetric profile**

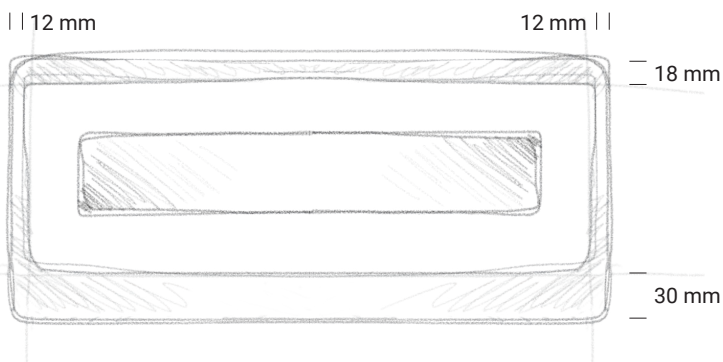

**Finishes**



# Aruba



52





Diffusore in vetro trasparente con bordo sabbiato asimmetrico. Elemento centrale in metallo nelle finiture galvaniche rame, oro, cromo oppure verniciato bianco raggrinzante. Montatura in metallo verniciato bianco raggrinzante.

Diffuser in clear glass with asymmetrical sandblasted edge. Central element in metal in copper, gold, chrome galvanic finishes or white wrinkle effect finish. Mount in white painted metal with wrinkle effect.







## Aruba\_S | 220-240 V | stripLED 17 W DC - 19 W AC



Product	Cct	Cri	lm S	lm D	Optics
 8920	3000	90	2212	1794	Diffused
 8921					
 8922					
 8923					

## Aruba\_S | 220-240 V | stripLED 35 W DC - 38 W AC



Product	Cct	Cri	lm S	lm D	Optics
 8924	3000	90	4228	3388	Diffused
 8925					
 8926					
 8927					

# Bart

Testa e corpo in alluminio verniciato bianco o nero raggrinzante. Diffusore in policarbonato trasparente.

Head and body in white or black wrinkle effect painted aluminium. Diffuser in clear polycarbonate.

**Bart\_S** | 220-240 V | arrayLED 8 W DC - 11 W AC

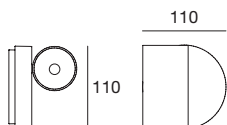

Product	Cct	Cri	lm S	lm D	Optics
8466	3000	90	1082	720	M.Flood (47°)
8467					

**Accessory Description**

**KIT0026** | Phase-cut dimmer (max. 100 W)

**Bart\_W Switch** | 220-240 V | arrayLED 4 W DC - 5 W AC

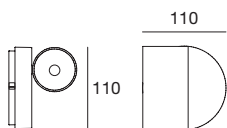

Product	Cct	Cri	lm S	lm D	Optics
7956	3000	90	627	434	M.Flood (37°)
7957					



On/Off switch



**Finishes**

White Black

# Beebo



Testa in alluminio verniciato bianco o nero raggrinzante. Corpo in alluminio verniciato bianco o nero raggrinzante oppure in legno rovere. Diffusore in policarbonato trasparente.

Head in white or black wrinkle effect painted aluminium. Body in wrinkle effect white or black painted aluminium or in oak wood. Diffuser in clear polycarbonate.



## Doppia connessione con un unico punto luce.

Con l'apposito accessorio acquistabile separatamente puoi combinare due Beebo a piacere sfruttando un singolo punto luce.

## Dual connection with a single point of light.

With the accessory available for purchase separately, you can combine two Beebos as you wish, using a single point of light.

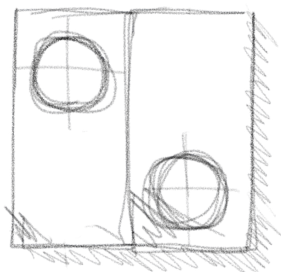

8461 x 2  
+ KIT0028

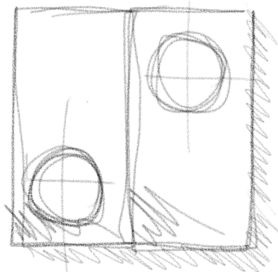

8462 x 2  
+ KIT0029

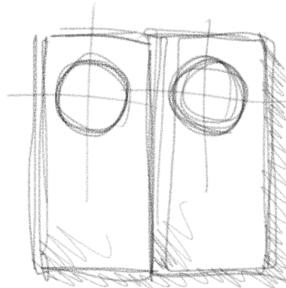

8460 x 2  
+ KIT0028

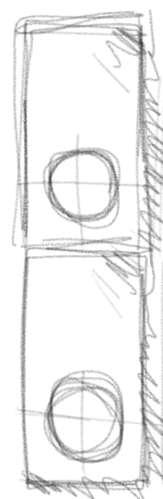

8460 x 2  
+ KIT0028

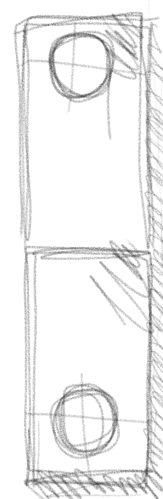

8461 x 2  
+ KIT0028

Beebo\_S | 220-240 V | arrayLED 8 W DC - 11 W AC

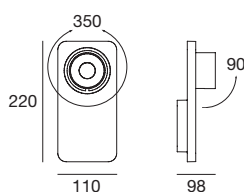
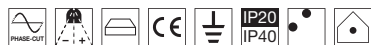

Product	Cct	Cri	Im S	Im D	Optics
8460	3000	90	1082	820	M.Flood (47°)
8461					
8462					

Accessory	Description
KIT0026	Phase-cut dimmer (max. 100 W)
KIT0028	Fixing bracket for modular installation (only for codes 8460-8461)
KIT0029	Fixing bracket for modular installation (only for code 8462)

### Finishes

White Black Oak Wood



Ceiling & Wall



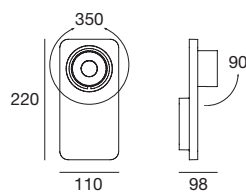

**Beebo\_W Switch** | 220-240 V | arrayLED 4 W DC - 5 W AC



Product	Cct	Cri	lm S	lm D	Optics
 7972	3000	90	627	434	M.Flood (37°)
 7973					
 7974					



**On/Off switch**

**Finishes**

 White  Black  Oak Wood

# Birba

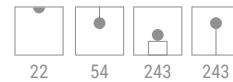

Corpo in ottone lucido, alluminio lucido o alluminio verniciato bianco raggrinzante. Montatura applique in metallo verniciato bianco raggrinzante.

Body in polished brass, polished or wrinkle effect white painted aluminium. Applique mount in wrinkle effect white painted metal.





Birba\_S | 220-240 V | GU10 / E27



GU10 E27

**Product Source**

White	<b>9373</b>	GU10
Polished Brass	<b>9375</b>	Max 7 W LED Bulb (not included)
Polished Aluminium	<b>9376</b>	

**Product Source**

White	<b>9421</b>	E27
Polished Brass	<b>9423</b>	Max 22 W LED Bulb (not included)
Polished Aluminium	<b>9424</b>	

Birba\_S | 220-240 V | GU10 / E27



GU10 E27

**Product Source**

White	<b>9379</b>	GU10
Polished Brass	<b>9381</b>	Max 7 W LED Bulb (not included)
Polished Aluminium	<b>9382</b>	

**Product Source**

White	<b>9427</b>	E27
Polished Brass	<b>9429</b>	Max 22 W LED Bulb (not included)
Polished Aluminium	<b>9430</b>	

Birba\_S | 220-240 V | GU10 / E27



GU10 E27

**Product Source**

White	<b>9385</b>	GU10
Polished Brass	<b>9387</b>	Max 7 W LED Bulb (not included)
Polished Aluminium	<b>9388</b>	

**Product Source**

White	<b>9433</b>	E27
Polished Brass	<b>9435</b>	Max 22 W LED Bulb (not included)
Polished Aluminium	<b>9436</b>	

**Attacco E27  
E27 fitting**



**Attacco regolabile GU10  
Adjustable GU10 fitting**

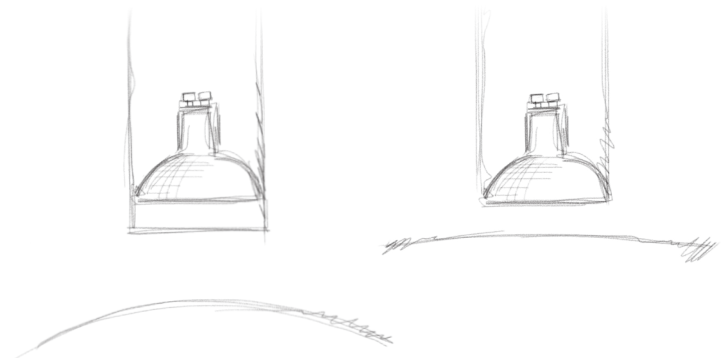

**Finishes**





**Birba\_W1 Mono emission** | 220-240 V | GU10 / E27

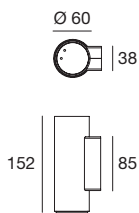

GU10 E27

**Product Source**

	<b>9391</b>	GU10
	<b>9393</b>	Max 7 W LED Bulb (not included)
	<b>9394</b>	

**Product Source**

	<b>9439</b>	E27
	<b>9441</b>	Max 13 W / Ø 60 mm LED Bulb (not included)
	<b>9442</b>	

**Birba\_W2 Bi emission** | 220-240 V | GU10 / E27

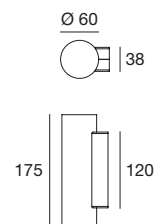

GU10 E27

**Product Source**

	<b>9397</b>	GU10
	<b>9399</b>	Max 2 x 7 W LED Bulb (not included)
	<b>9400</b>	

**Product Source**

	<b>9445</b>	E27
	<b>9447</b>	Max 2 x 13 W / Ø 60 mm LED Bulb (not included)
	<b>9448</b>	



**Finishes**

White   Brass / White   Aluminium / White

**Ceiling & Wall**

# Box

Lampada da soffitto in alluminio verniciato bianco raggrinzante con diffusore in polimetilmetacrilato satinato.  
Lampada a parete in metallo verniciato bianco o nero raggrinzante, grigio cemento, ottone o rame spazzolato.  
Diffusore in polimetilmetacrilato satinato.

Ceiling light in wrinkle effect white painted aluminium with satin polymethylmethacrylate diffuser. Wall light in wrinkle effect white or black painted metal, concrete grey, brass or brushed copper. Satin-finish polymethylmethacrylate diffuser.



**Box\_SR** | 220-240 V | topLED 6 W DC - 7 W AC

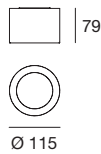

Product	Cct	Cri	lm S	lm D	Optics
<b>8236</b>	3000	80	790	565	Diffused
<b>8236N</b>	4000	80	830	635	Diffused

**Box\_SR** | 220-240 V | topLED 15 W DC - 17 W AC

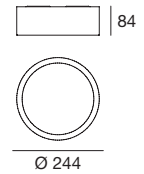

Product	Cct	Cri	lm S	lm D	Optics
<b>8238</b>	3000	80	1940	1383	Diffused
<b>8238N</b>	4000	80	2020	1556	Diffused

**Accessory Description**

**KIT0026** | Phase-cut dimmer (max. 100 W)

**Box\_SR** | 220-240 V | topLED 23 W DC - 25 W AC

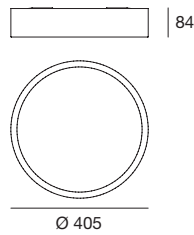

Product	Cct	Cri	lm S	lm D	Optics
<b>8240</b>	3000	80	2867	2030	Diffused
<b>8240N</b>	4000	80	3156	2252	Diffused

**Accessory Description**

**KIT0026** | Phase-cut dimmer (max. 100 W)

**Box\_SR** | 220-240 V | topLED 43 W DC - 48 W AC

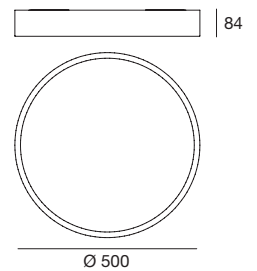

Product	Cct	Cri	lm S	lm D	Optics
<b>8242</b>	3000	80	5314	3842	Diffused
<b>8242N</b>	4000	80	5568	4325	Diffused

**Accessory Description**

**KIT0026** | Phase-cut dimmer (max. 100 W)

**Finishes**

White



**Box\_SQ** | 220-240 V | topLED 6 W DC - 7 W AC

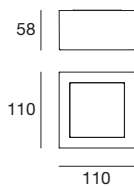

Product	Cct	Cri	lm S	lm D	Optics
<b>8227</b>	3000	80	792	563	Diffused
<b>8227N</b>	4000	80	856	634	Diffused

**Box\_SQ** | 220-240 V | topLED 15 W DC - 17 W AC

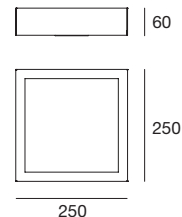

Product	Cct	Cri	lm S	lm D	Optics
<b>8229</b>	3000	80	1895	1362	Diffused
<b>8229N</b>	4000	80	2103	1572	Diffused

**Accessory Description**

**KIT0026** | Phase-cut dimmer (max. 100 W)

**Box\_SQ** | 220-240 V | topLED 23 W DC - 25 W AC

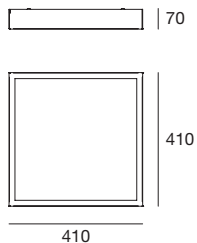

Product	Cct	Cri	lm S	lm D	Optics
<b>8231</b>	3000	80	3418	2402	Diffused
<b>8231N</b>	4000	80	3594	2706	Diffused

**Accessory Description**

**KIT0026** | Phase-cut dimmer (max. 100 W)

**Box\_SQ** | 220-240 V | topLED 43 W DC - 48 W AC

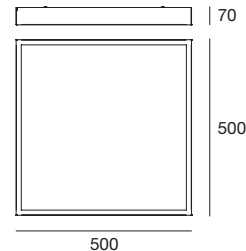
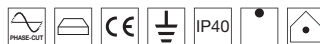

Product	Cct	Cri	lm S	lm D	Optics
<b>8233</b>	3000	80	5090	3441	Diffused
<b>8233N</b>	4000	80	5214	3875	Diffused

**Accessory Description**

**KIT0026** | Phase-cut dimmer (max. 100 W)

**Finishes**

White



**Box\_SB** | 220-240 V | topLED 18 W DC - 20 W AC

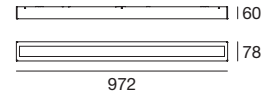

Product	Cct	Cri	lm S	lm D	Optics
<input type="checkbox"/> <b>8259</b>	3000	80	2618	1530	Diffused
<input type="checkbox"/> <b>8259N</b>	4000	80	2879	1750	Diffused

**Accessory Description**

**KIT0026** | Phase-cut dimmer (max. 100 W)

**Box\_SB** | 220-240 V | topLED 24 W DC - 26 W AC

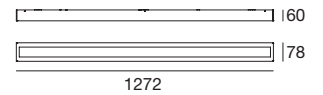

Product	Cct	Cri	lm S	lm D	Optics
<input type="checkbox"/> <b>8260</b>	3000	80	3490	1995	Diffused
<input type="checkbox"/> <b>8260N</b>	4000	80	3839	2255	Diffused

**Accessory Description**

**KIT0026** | Phase-cut dimmer (max. 100 W)





**Box\_W1 Mono Emission** | 220-240 V | topLED 5 W DC - 6 W AC

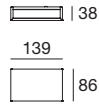

Product	Cct	Cri	lm S	lm D	Optics
8770M	2700	80	525	444	Diffused
8771M					
9540M					
8912M					
8913M					
8770	3000	80	540	499	Diffused
8771					
9540					
8912					
8913					
8770N	4000	80	596	550	Diffused
8771N					
9540N					

**Box\_W1 Mono Emission** | 220-240 V | topLED 13 W DC - 14 W AC

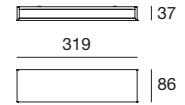

Product	Cct	Cri	lm S	lm D	Optics
8772M	2700	80	1484	1004	Diffused
8773M					
9541M					
8914M					
8915M					
8772	3000	80	1543	1168	Diffused
8773					
9541					
8914					
8915					
8772N	4000	80	1677	1285	Diffused
8773N					
9541N					

**Accessory Description**

**KIT0026** | Phase-cut dimmer (max. 100 W)

**Box\_W1 Mono Emission** | 220-240 V | topLED 26 W DC - 28 W AC

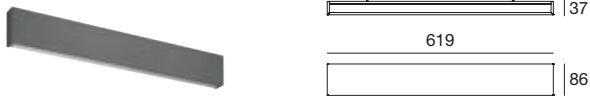

Product	Cct	Cri	lm S	lm D	Optics
<b>8774M</b>	2700	80	2968	2007	Diffused
<b>8775M</b>					
<b>9542M</b>					
<b>8916M</b>					
<b>8917M</b>					
<b>8774</b>	3000	80	3087	2334	Diffused
<b>8775</b>					
<b>9542</b>					
<b>8916</b>					
<b>8917</b>					
<b>8774N</b>	4000	80	3354	2568	Diffused
<b>8775N</b>					
<b>9542N</b>					

Accessory	Description
<b>KIT0026</b>	Phase-cut dimmer (max. 100 W)

**Box\_W1 Mono Emission** | 220-240 V | topLED 40 W DC - 41 W AC

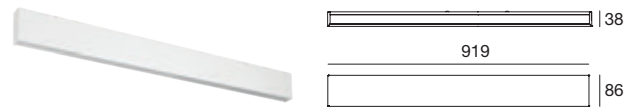

Product	Cct	Cri	lm S	lm D	Optics
<b>8776M</b>	2700	80	4452	2940	Diffused
<b>8777M</b>					
<b>9543M</b>					
<b>8918M</b>					
<b>8919M</b>					
<b>8776</b>	3000	80	4630	3419	Diffused
<b>8777</b>					
<b>9543</b>					
<b>8918</b>					
<b>8919</b>					
<b>8776N</b>	4000	80	5031	3760	Diffused
<b>8777N</b>					
<b>9543N</b>					

Accessory	Description
<b>KIT0026</b>	Phase-cut dimmer (max. 100 W)

**Finishes**



**Ceiling & Wall**





**Box\_W2 Bi Emission** | 220-240 V | topLED 9 W DC - 10 W AC

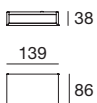

Product	Cct	Cri	lm S	lm D	Optics
8255M	2700	80	1043	730	Diffused
8261M					
9545M					
9532M					
9533M					
8255	3000	80	1092	795	Diffused
8261					
9545					
9532					
9533					
8255N	4000	80	1166	895	Diffused
8261N					
9545N					

Accessory	Description
KIT0026	Phase-cut dimmer (max. 100 W)

**Box\_W2 Bi Emission** | 220-240 V | topLED 18 W DC - 19 W AC

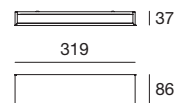
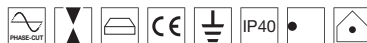

Product	Cct	Cri	lm S	lm D	Optics
8256M	2700	80	2306	1314	Diffused
8262M					
9546M					
9534M					
9535M					
8256	3000	80	2370	1510	Diffused
8262					
9546					
9534					
9535					
8256N	4000	80	2598	1700	Diffused
8262N					
9546N					

Accessory	Description
KIT0026	Phase-cut dimmer (max. 100 W)

**Box\_W2 Bi Emission** | 220-240 V | topLED 25 W DC - 28 W AC

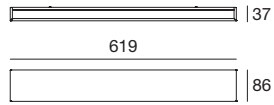

Product	Cct	Cri	Im S	Im D	Optics
<b>8257M</b>	2700	80	3425	1914	Diffused
<b>8263M</b>					
<b>9547M</b>					
<b>9536M</b>					
<b>9537M</b>					
<b>8257</b>	3000	80	3490	2225	Diffused
<b>8263</b>					
<b>9547</b>					
<b>9536</b>					
<b>9537</b>					
<b>8257N</b>	4000	80	3839	2501	Diffused
<b>8263N</b>					
<b>9547N</b>					

Accessory	Description
<b>KIT0026</b>	Phase-cut dimmer (max. 100 W)

**Box\_W2 Bi Emission** | 220-240 V | topLED 37 W DC - 41 W AC

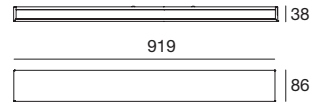

Product	Cct	Cri	Im S	Im D	Optics
<b>8258M</b>	2700	80	5137	2800	Diffused
<b>8264M</b>					
<b>9548M</b>					
<b>9538M</b>					
<b>9539M</b>					
<b>8258</b>	3000	80	5235	3255	Diffused
<b>8264</b>					
<b>9548</b>					
<b>9538</b>					
<b>9539</b>					
<b>8258N</b>	4000	80	5758	3665	Diffused
<b>8264N</b>					
<b>9548N</b>					

Accessory	Description
<b>KIT0026</b>	Phase-cut dimmer (max. 100 W)

**Finishes**



**Ceiling & Wall**

# Circular



296

Corpo in metallo verniciato bianco raggrinzante oppure in finitura gavanica cromo. Diffusore in polimetilmetacrilato sabbiato.

Body in wrinkle effect white painted metal or in gavanic chrome finish. Sandblasted polymethylmethacrylate diffuser.





**Circular** | 220-240 V | topLED 7 W DC - 8 W AC

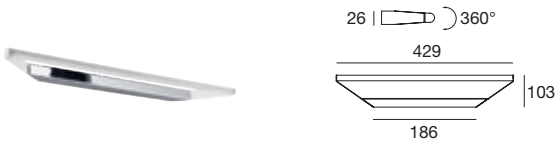

Product	Cct	Cri	lm S	lm D	Optics
□ 8405	3000	80	1022	710	Diffused
■ 8406					

**Circular** | 220-240 V | topLED 10 W DC - 11 W AC

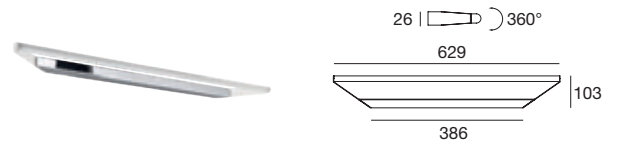

Product	Cct	Cri	lm S	lm D	Optics
□ 8409	3000	80	1441	971	Diffused
■ 8410					

**Circular** | 220-240 V | topLED 15 W DC - 19 W AC

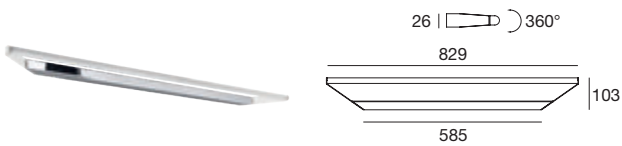

Product	Cct	Cri	lm S	lm D	Optics
□ 8413	3000	80	2119	1680	Diffused
■ 8414					

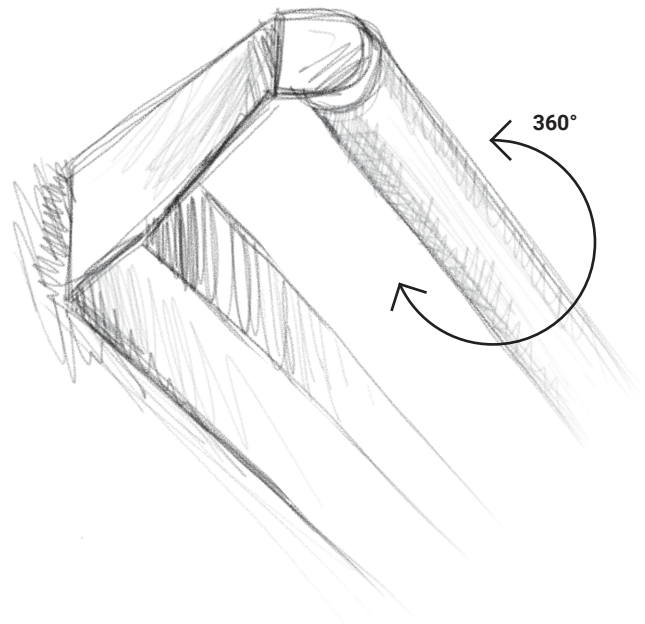

**Finishes**

□ White    ■ White / Chrome

# Crew



59/61

Corpo in metallo verniciato in varie finiture e combinazioni cromatiche. Diffusore in polimetilmetacrilato opalino.

Painted metal body in various finishes and colour combinations. Diffuser in opal polymethylmethacrylate.



Crew\_1 | 220-240 V | topLED 11 W DC - 12 W AC

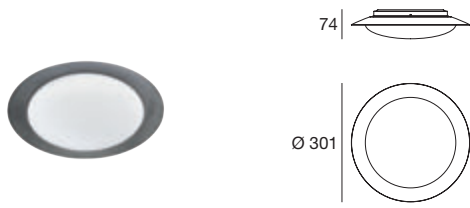

Product	Cct	Cri	lm S	lm D	Optics
8270	3000	80	1253	900	Diffused
8271					
8272					

Crew\_1 | 220-240 V | topLED 14 W DC - 17 W AC

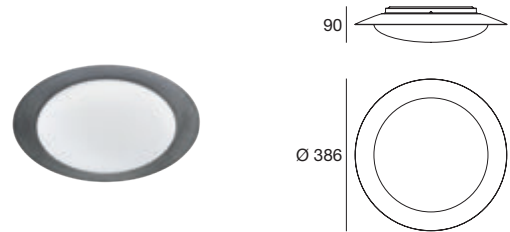

Product	Cct	Cri	lm S	lm D	Optics
8275	3000	80	1628	1200	Diffused
8276					
8277					

Crew\_1 | 220-240 V | topLED 21 W DC - 22 W AC

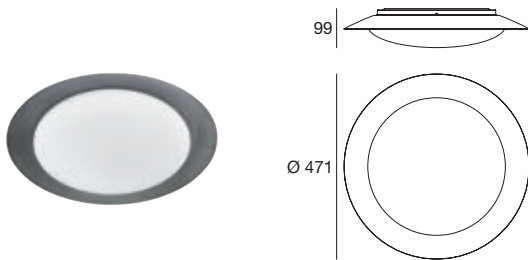

Product	Cct	Cri	lm S	lm D	Optics
8280	3000	80	2460	1800	Diffused
8281					
8282					



White



Dark Grey



Burnished

Finishes





Crew\_2 | 220-240 V | topLED 11 W DC - 12 W AC

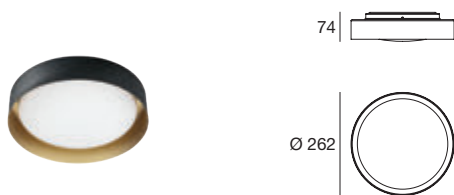

Product	Cct	Cri	lm S	lm D	Optics
8285	3000	80	1253	824	Diffused
8286					
8287					
8288					
8289					

Crew\_2 | 220-240 V | topLED 14 W DC - 17 W AC

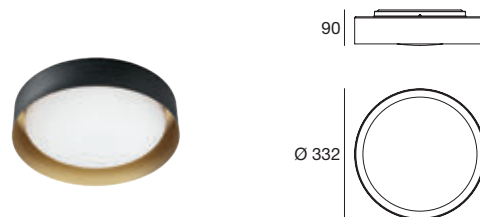

Product	Cct	Cri	lm S	lm D	Optics
8292	3000	80	1628	1097	Diffused
8293					
8294					
8295					
8296					

Crew\_2 | 220-240 V | topLED 21 W DC - 22 W AC

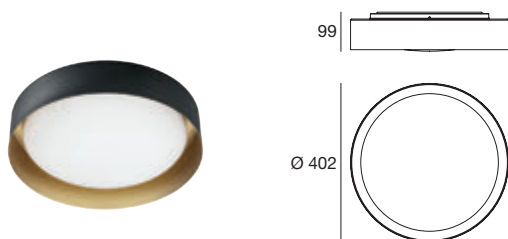

Product	Cct	Cri	lm S	lm D	Optics
8299	3000	80	2460	1648	Diffused
8300					
8301					
8302					
8303					



White



White / Painted copper



Black / White



Black / Painted Gold



Sablè / Tiffany green

Finishes



# Crumb

Corpo in metallo verniciato bianco o nero raggrinzante.  
Diffusore in vetro borosilicato trasparente oppure fumé.

Body in wrinkle effect white or black painted metal.  
Diffuser in clear or smoked borosilicate glass.





**Crumb** | 220-240 V | topLED 9 W DC - 10 W AC

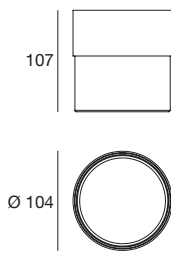

Product	Cct	Cri	lm S	lm D	Optics
□ 90281	3000	90	1013	516	Diffused
■ 90296					

**Crumb** | 220-240 V | topLED 13 W DC - 15 W AC

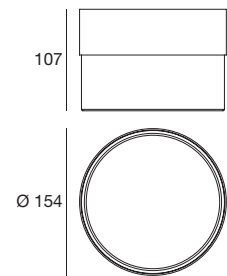

Product	Cct	Cri	lm S	lm D	Optics
□ 90282	3000	90	1653	828	Diffused
■ 90297					

**Finishes**

□ White / Transparent    ■ Black / Smoked

# Curvè

Corpo in alluminio verniciato bianco  
raggrinzante, grigio cemento o dark brown.  
Diffusore in polimetilmetacrilato satinato.

Aluminium wrinkle effect body painted white,  
concrete grey or dark brown. Satin-finish  
polymethylmethacrylate diffuser.





**Curvè LED** | 220-240 V | topLED 12 W DC - 15 W AC



Product	Cct	Cri	lm S	lm D	Optics
1140	3000	90	1490	958	Diffused
1141					
1146					

**Curvè LED** | 220-240 V | topLED 24 W DC - 30 W AC

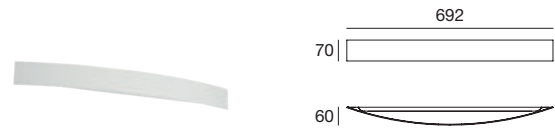

Product	Cct	Cri	lm S	lm D	Optics
1143	3000	90	2980	2211	Diffused
1144					
1147					

**Curvè LED** | 220-240 V | topLED 32 W DC - 35 W AC

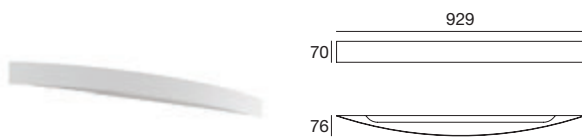

Product	Cct	Cri	lm S	lm D	Optics
1190	3000	90	4430	2590	Diffused
1191					
1192					

**Finishes**

White Dark Brown Concrete

# Dublight



Diffusore in polimetilmetacrilato satinato.  
Montatura in metallo verniciato bianco raggrinzante.

Satin-finish polymethylmethacrylate diffuser.  
Mount in white painted metal with wrinkle effect.



**Dublight\_SQ** | 220-240 V | topLED 6 W DC - 7 W AC

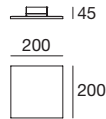

Product	Cct	Cri	lm S	lm D	Optics
□ 7488	3000	80	759	568	Diffused

**Dublight\_SQ** | 220-240 V | topLED 21 W DC - 23 W AC

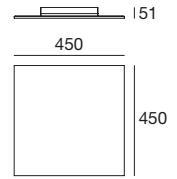

Product	Cct	Cri	lm S	lm D	Optics
□ 7489	3000	80	2800	1824	Diffused

**Dublight\_SQ** | 220-240 V | topLED 38 W DC - 42 W AC

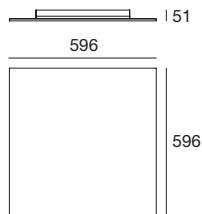

Product	Cct	Cri	lm S	lm D	Optics
□ 7490	3000	80	4485	3374	Diffused

**Dublight\_SB** | 220-240 V | topLED 32 W DC - 35 W AC

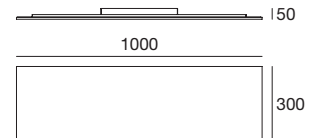

Product	Cct	Cri	lm S	lm D	Optics
□ 7491	3000	80	4200	2821	Diffused

**Finishes**

□ White



**Dublight\_W** | 220-240 V | topLED 6 W DC - 7 W AC

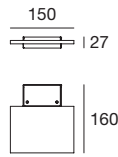

Product	Cct	Cri	lm S	lm D	Optics
<input type="checkbox"/> <b>7485</b>	3000	80	759	515	Diffused

**Dublight\_W** | 220-240 V | topLED 12 W DC - 13 W AC

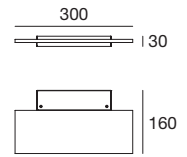

Product	Cct	Cri	lm S	lm D	Optics
<input type="checkbox"/> <b>7486</b>	3000	80	1574	813	Diffused

**Dublight\_W** | 220-240 V | topLED 24 W DC - 27 W AC

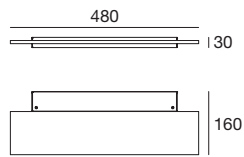

Product	Cct	Cri	lm S	lm D	Optics
<input type="checkbox"/> <b>7487</b>	3000	80	3148	1713	Diffused

# Duck

Corpo in alluminio verniciato bianco o nero raggrinzante.  
Sfera in metallo nelle finiture galvaniche oro o cromo.

Body in white or black wrinkle effect painted aluminium.  
Metal sphere in gold or chrome galvanic finishes.



Duck\_S | 220-240 V | powerLED 8 W DC - 10 W AC

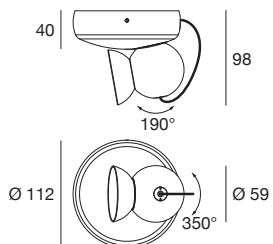

Product	Cct	Cri	lm S	lm D	Optics
<input type="checkbox"/> 9633M <input checked="" type="checkbox"/> 9634M	2700	90	719	458	M.Flood (45°)
<input type="checkbox"/> 9633 <input checked="" type="checkbox"/> 9634	3000	90	782	498	M.Flood (45°)

Accessory	Description
KIT0026	Phase-cut dimmer (max. 100 W)

## Ruota, gira, sposta: è magnetica, puoi orientarla come vuoi.

L'attacco magnetico permette una rotazione orbitale della testa. Lo scorrimento è perfetto e non intacca mai la superficie liscia della sfera: puoi girarla quante volte vuoi!

## Rotate, turn, move - orient this magnetic fitting as you wish!

Magnetic attachment allows for the orbital rotation of the head which slides perfectly without ever affecting the smooth surface of the sphere, so you can turn it as many times as you want!

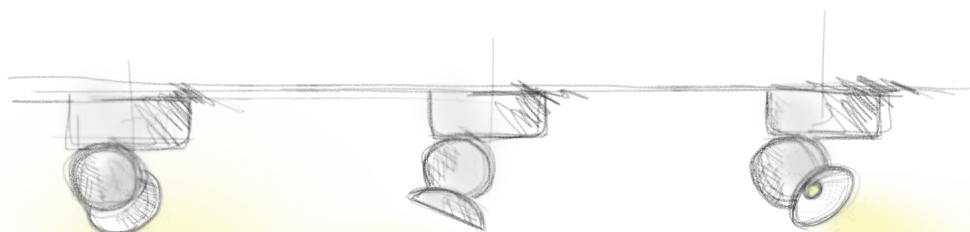

### Finishes

White / Chrome   
  Black / Gold









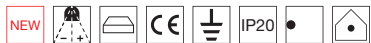

**Duck\_W** | 220-240 V | powerLED 4 W DC - 5 W AC

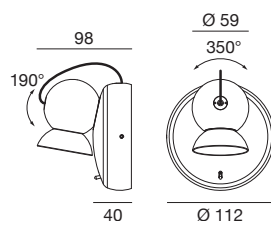

SCALE 1:1



Product	Cct	Cri	lm S	lm D	Optics
 <b>9630M</b>  <b>9631M</b>	2700	90	368	318	M.Flood (45°)
 <b>9630</b>  <b>9631</b>	3000	90	400	346	M.Flood (45°)

**Finishes**

 White / Chrome     Black / Gold

# Eta

Corpo in alluminio verniciato  
bianco o nero raggrinzante.

Body in white or black wrinkle  
effect painted aluminium.



299



Eta | 198-264 V | arrayLED 9 W DC - 11 W AC

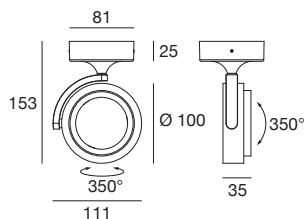

Product	Cct	Cri	lm S	lm D	Optics
□ 9908	3000	90	958	856	Spot
■ 9911					
□ 9909	3000	90	958	856	M.Flood
■ 9912					
□ 9910	3000	90	958	856	W.Flood
■ 9913					

Accessory	Description
KIT0026	Phase-cut dimmer (max. 100 W)



Finishes

□ White ■ Black

# Gemini



254

Corpo in grés nelle finiture statuaretto o nero greco, oppure in vetro bronzato specchiato. Diffusore in polimetilmetacrilato satinato. Montatura in metallo verniciato bianco raggrinzante.





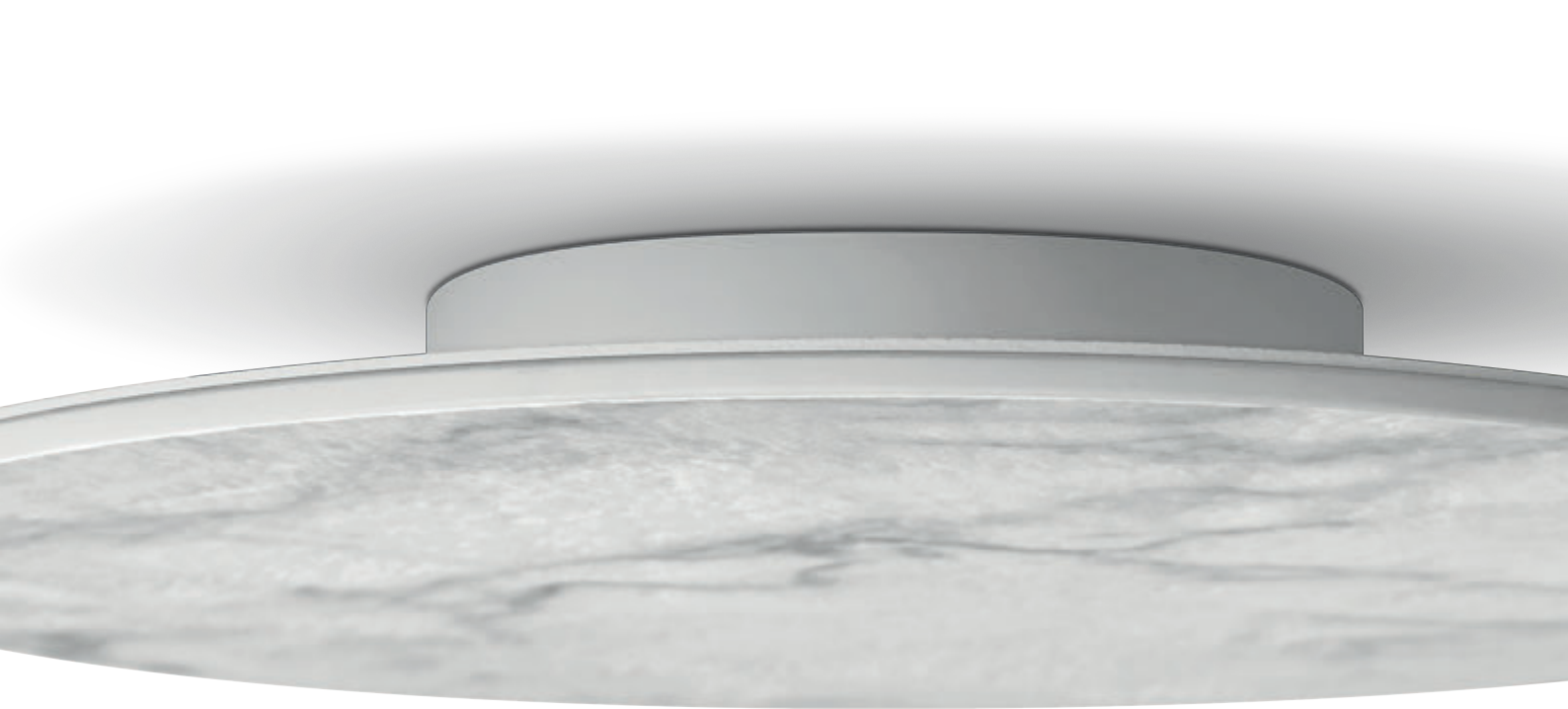

Body in stoneware with statuaretto or nero greco finishes, or in bronze mirrored glass. Satin-finish polymethylmethacrylate diffuser. Mount in white painted metal with wrinkle effect.

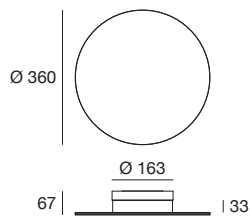



**Gemini\_S** | 220-240 V | topLED 24 W DC - 26 W AC



Product	Cct	Cri	lm S	lm D	Optics
 <b>9666M</b>	2700	90	2593	1895	Diffused
 <b>9667M</b>					
 <b>9668M</b>					
 <b>9666</b>	3000	90	2818	2060	Diffused
 <b>9667</b>					
 <b>9668</b>					

**Finishes**





**Gemini\_W1** | 220-240 V | topLED 13 W DC - 14 W AC

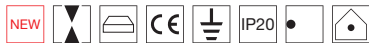

Product	Cct	Cri	lm S	lm D	Optics
<b>9669M</b>	2700	90	1216	810	Diffused
<b>9670M</b>					
<b>9671M</b>					
<b>9669</b>	3000	90	1322	880	Diffused
<b>9670</b>					
<b>9671</b>					

**Gemini\_W1** | 220-240 V | topLED 25 W DC - 28 W AC

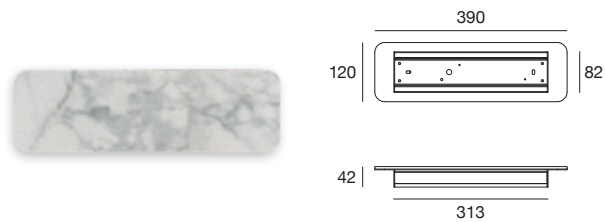

Product	Cct	Cri	lm S	lm D	Optics
<b>9672M</b>	2700	90	2248	1524	Diffused
<b>9673M</b>					
<b>9674M</b>					
<b>9672</b>	3000	90	2443	1656	Diffused
<b>9673</b>					
<b>9674</b>					

Accessory	Description
<b>KIT0026</b>	Phase-cut dimmer (max. 100 W)

**Gemini\_W2** | 220-240 V | topLED 18 W DC - 19 W AC

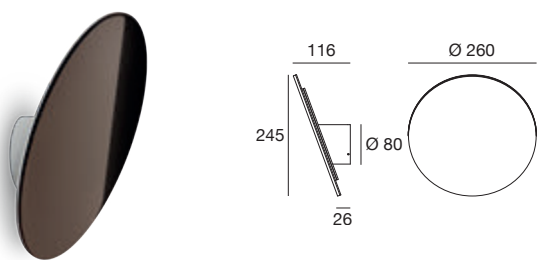

Product	Cct	Cri	lm S	lm D	Optics
<b>9675M</b>	2700	90	1984	1926	Diffused
<b>9676M</b>					
<b>9677M</b>					
<b>9675</b>	3000	90	2157	2094	Diffused
<b>9676</b>					
<b>9677</b>					



**Finishes**



# Goose

Corpo in alluminio verniciato bianco o nero  
raggrinzante. Snodo in oro o nickel satinato.  
Diffusore in polimetilmetacrilato trasparente.

Body in white or black wrinkle effect painted  
aluminium. Joint in gold or satin nickel.  
Diffuser in clear polymethylmethacrylate.





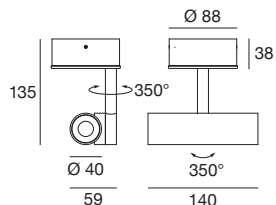

Product	Cct	Cri	lm S	lm D	Optics
9727M	2700	90	690	587	Flood (28°)
9728M					
9730M					
9731M					
9727	3000	90	750	638	Flood (28°)
9728					
9730					
9731					

Accessory	Description
KIT0026	Phase-cut dimmer (max. 100 W)



## Totale libertà di movimento e puntamento.

Gli snodi consentono una rotazione orbitale di 350° su entrambi gli assi, compresa la posizione zenitale: puoi utilizzare Goose come proiettore o persino come cilindro a soffitto.

## Total freedom of movement and direction.

The joints allow for a 350° orbital rotation along both axes, including the zenith position so you can use Goose as a projector or even as a ceiling cylinder.



### Finishes

White / Brushed Gold    Black / Brushed Nickel    White / Brushed Nickel    Black / Brushed Gold

# Gypsum

Corpo in gesso verniciabile.  
Diffusore in vetro sabbato.

Paintable plaster body.  
Sandblasted glass diffuser.



**Gypsum\_W1 Mono Emission** | 220-240 V | topLED 7 W DC - 7,5 W AC

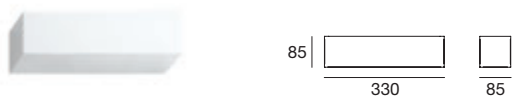

Product	Cct	Cri	Im S	Im D	Optics
<b>60834W00</b>	3000	80	1157	562	Diffused
<b>60834N00</b>	4000	80	1157	562	Diffused

**Gypsum\_W2 Bi Emission** | 220-240 V | topLED 13 W DC - 15 W AC



Product	Cct	Cri	Im S	Im D	Optics
<b>60817W00</b>	3000	80	2040	1118	Diffused
<b>60817N00</b>	4000	80	2040	1118	Diffused

**Gypsum\_W3 Bi Emission** | 220-240 V | topLED 22 W DC - 25 W AC



Product	Cct	Cri	Im S	Im D	Optics
<b>60819W00</b>	3000	80	3492	1912	Diffused
<b>60819N00</b>	4000	80	3492	1912	Diffused



**Finishes**

White

# Halfpipe 2

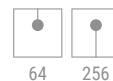

Corpo in alluminio lucido o verniciato bianco o nero raggrinzante. Diffusore in policarbonato.

Body in polished or wrinkle effect white or black painted aluminium. Polycarbonate diffuser.



Halfpipe 2\_W | 220-240 V | topLED 9 W DC - 11 W AC

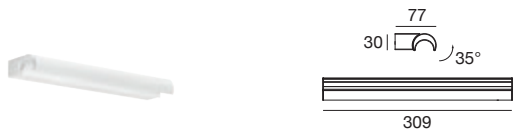

Product	Cct	Cri	lm S	lm D	Optics
9800	3000	90	1175	673	Diffused
9801					
9802					

Halfpipe 2\_W | 220-240 V | topLED 18 W DC - 21 W AC

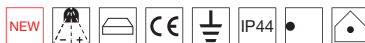

Product	Cct	Cri	lm S	lm D	Optics
9803	3000	90	2350	1517	Diffused
9804					
9805					

Halfpipe 2\_W | 220-240 V | topLED 25 W DC - 28 W AC



Product	Cct	Cri	lm S	lm D	Optics
9806	3000	90	3361	1929	Diffused
9807					
9808					

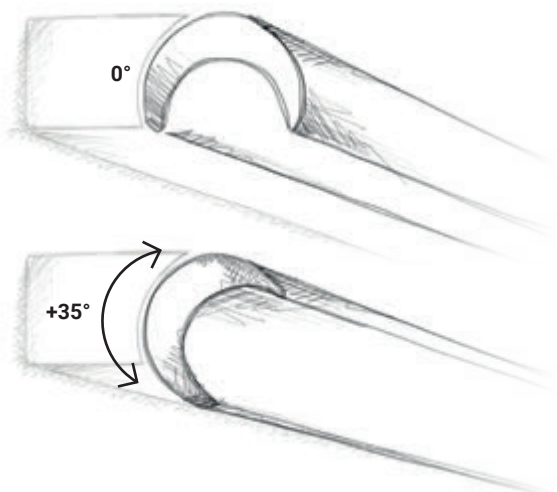

Finishes



# Horizon



66

Disco riflettente in vetro serigrafato/sabbiato, cupola inferiore in metallo nelle finiture galvaniche oro o cromo, oppure verniciato bianco raggrinzante. Montatura in metallo verniciato bianco raggrinzante.



Reflecting disc in silk-screened/sandblasted glass, lower dome in metal in galvanic gold or chrome finishes, or white wrinkle effect painted. Mount in white painted metal with wrinkle effect.



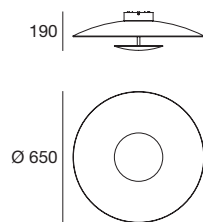

**Horizon\_S** | 220-240 V | topLED 29 W DC - 34 W AC



Product	Cct	Cri	lm S	lm D	Optics
 90285	3000	80	3652	2770	Diffused
 90284					
 90283					

**Finishes**

 White    White / Gold    White / Chrome

# Igloo

SYS  
TEM  
274

Corpo in alluminio lucido o verniciato bianco o nero  
raggrinzante. Diffusore in polimetilmetacrilato opalino.

Body in polished or wrinkle effect white or black painted  
aluminium. Diffuser in opal polymethylmethacrylate.





**Igloo\_S ON/OFF** | 220-240 V | topLED 16 W DC - 20 W AC



Product	Cct	Cri	Im S	Im D	Optics
9135	3000	90	2306	1316	Diffused
9136					
9137					

**Igloo\_S DALI** | 220-240 V | topLED 16 W DC - 20 W AC



Product	Cct	Cri	Im S	Im D	Optics
9138	3000	90	2306	1316	Diffused
9139					
9140					

Accessory	Description
KIT0096	Junction bracket

**Igloo\_S DALI** | 220-240 V | topLED 33 W DC - 36 W AC



Product	Cct	Cri	Im S	Im D	Optics
9141	3000	90	4470	3139	Diffused
9142					
9143					

Accessory	Description
KIT0098	Junction bracket

**Igloo\_S DALI** | 220-240 V | topLED 50 W DC - 53 W AC

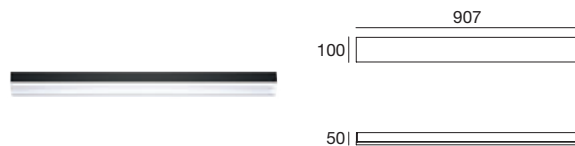
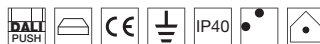

Product	Cct	Cri	Im S	Im D	Optics
9144	3000	90	6636	4833	Diffused
9145					
9146					

Accessory	Description
KIT0099	Junction bracket





308  
35 |

58 |

Product	Cct	Cri	Im S	Im D	Optics
9147	3000	90	1556	874	Diffused
9148					
9149					



607  
35 |

58 |

Product	Cct	Cri	Im S	Im D	Optics
9150	3000	90	3364	1962	Diffused
9151					
9152					



# Kioo

Corpo in alluminio anodizzato o verniciato bianco raggrinzante. Diffusore in policarbonato opalino.

Body in anodised aluminium or painted wrinkle effect white. Opal polycarbonate diffuser.



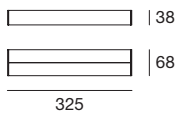

Product	Cct	Cri	Im S	Im D	Optics
7904	3000	90	1516	1004	Diffused
7905					

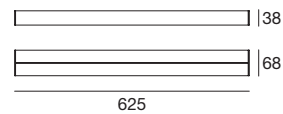

Product	Cct	Cri	Im S	Im D	Optics
7906	3000	90	3030	2030	Diffused
7907					



# Metal

Corpo in alluminio verniciato bianco o nero raggrinzante.  
Diffusore in polimetilmetacrilato opalino.

Body in white or black wrinkle effect painted aluminium.  
Diffuser in opal polymethylmethacrylate.



**Metal** | 220-240 V | topLED 9 W DC - 11 W AC



Product	Cct	Cri	lm S	lm D	Optics
<b>90320</b>	3000	90	1104	737	Diffused
<b>90332</b>					

**Metal** | 220-240 V | topLED 17 W DC - 20 W AC

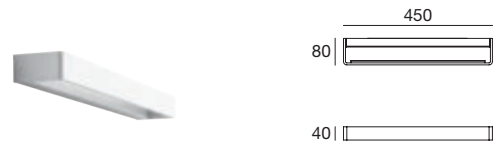

Product	Cct	Cri	lm S	lm D	Optics
<b>90322</b>	3000	90	2090	1338	Diffused
<b>90333</b>					

**Metal** | 220-240 V | topLED 26 W DC - 30 W AC

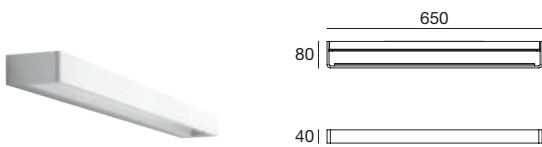

Product	Cct	Cri	lm S	lm D	Optics
<b>90324</b>	3000	90	3077	2007	Diffused
<b>90334</b>					

**Finishes**

White Black

# Mille

Corpo in metallo verniciato bianco.  
Diffusore in vetro sabbato bianco.

White painted metal body.  
White sandblasted glass diffuser.





**Mille\_W1 LED** | 220-240 V | topLED 6 W DC - 8 W AC

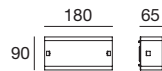

Product	Cct	Cri	lm S	lm D	Optics
7836	3000	90	710	526	Diffused

Nickel and cherry finals included.

**Mille\_W1 LED** | 220-240 V | topLED 9 W DC - 9,5 W AC

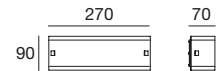

Product	Cct	Cri	lm S	lm D	Optics
7838	3000	90	1023	758	Diffused

Nickel and cherry finals included.

**Mille\_W1 LED** | 220-240 V | topLED 12 W DC - 14 W AC

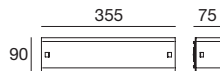

Product	Cct	Cri	lm S	lm D	Optics
7840	3000	90	1421	975	Diffused

Nickel and cherry finals included.

**Mille\_W1 LED** | 220-240 V | topLED 18 W DC - 20 W AC

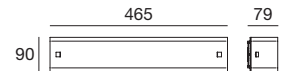

Product	Cct	Cri	lm S	lm D	Optics
7842	3000	90	2046	1643	Diffused

Nickel and cherry finals included.

**Mille\_W1 LED** | 220-240 V | topLED 24 W DC - 28 W AC



Product	Cct	Cri	lm S	lm D	Optics
7844	3000	90	2929	2266	Diffused

Nickel and cherry finals included.

**Mille\_W1 LED** | 220-240 V | topLED 30 W DC - 34 W AC

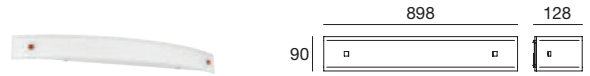

Product	Cct	Cri	lm S	lm D	Optics
7846	3000	90	3408	2560	Diffused

Nickel and cherry finals included.

**Mille\_W1 LED** | 220-240 V | topLED 30 W DC - 34 W AC

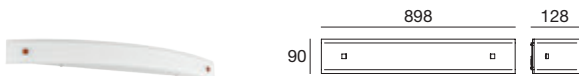

Product	Cct	Cri	lm S	lm D	Optics
7848	3000	90	3408	2560	Diffused

Nickel and cherry finals included.

**Mille\_W2 LED** | 220-240 V | topLED 12 W DC - 14 W AC



Product	Cct	Cri	lm S	lm D	Optics
7850	3000	90	1417	989	Diffused

Nickel and cherry finals included.



**Mille\_SB LED** | 220-240 V | topLED 26 W DC - 29 W AC

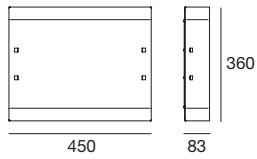

Product	Cct	Cri	lm S	lm D	Optics
7852	3000	90	2809	1920	Diffused

Nickel and cherry finals included.

**Mille\_SB LED** | 220-240 V | topLED 32 W DC - 34 W AC

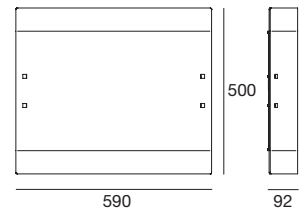

Product	Cct	Cri	lm S	lm D	Optics
7854	3000	90	3678	2240	Diffused

Nickel and cherry finals included.

**Finishes**

White / Sandblasted Glass

# Minion



70

Testa e corpo in alluminio verniciato bianco o nero raggrinzante. Diffusore in polimetilmetacrilato trasparente.

Head and body in white or black wrinkle effect painted aluminium. Transparent polymethylmethacrylate diffuser.



**Minion\_S1** | 220-240 V | powerLED 5 W DC - 6 W AC

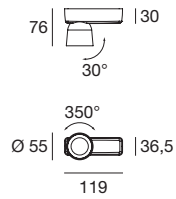

Product	Cct	Cri	lm S	lm D	Optics
<b>8744</b>	3000	90	610	554	Spot (21°)
<b>8746</b>					
<b>8740</b>	3000	90	610	508	M.Flood (47°)
<b>8742</b>					



SCALE 1:1

**Minion\_S2** | 220-240 V | powerLED 11 W DC - 12 W AC

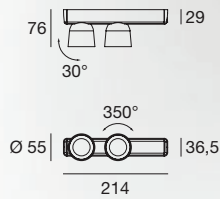

Product	Cct	Cri	lm S	lm D	Optics
<b>8752</b>	3000	90	1872	1280	Spot (22°)
<b>8754</b>					
<b>8748</b>	3000	90	1872	1198	M.Flood (48°)
<b>8750</b>					



Anelli bianco e rame inclusi con codici: 8744, 8740, 8752, 8748.

White and copper rings included with codes: 8744, 8740, 8752, 8748.



Anelli nero e oro inclusi con codici: 8746, 8742, 8754, 8750.

Black and gold rings included with codes: 8746, 8742, 8754, 8750.

**Finishes**

White Black

# Oh!

Diffusore in polietilene.  
Montatura in policarbonato bianco.



Polyethylene diffuser.  
White polycarbonate mount.



**Oh!\_S LED** | 220-240 V | topLED 7 W DC - 8 W AC



Product	Cct	Cri	Im S	Im D	Optics
□ 12131	3000	80	1022	845	Diffused

**Oh!\_S E27** | 220-240 V



Product	Source
□ 12122	E27 1 x 30 W Max Halogen (LED bulbs compatible)

**Oh!\_S LED** | 220-240 V | topLED 13 W DC - 15 W AC

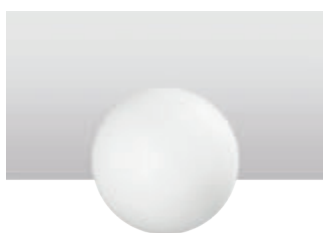

Product	Cct	Cri	Im S	Im D	Optics
□ 12132	3000	80	1930	1585	Diffused

**Oh!\_S E27** | 220-240 V

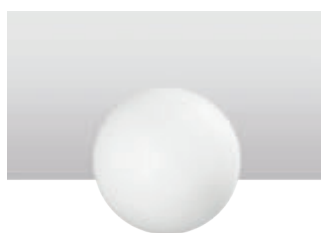

Product	Source
□ 12124	E27 1 x 46 W Max Halogen (LED bulbs compatible)

**Oh!\_S LED** | 220-240 V | topLED 18 W DC - 20 W AC

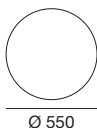

Product	Cct	Cri	Im S	Im D	Optics
□ 12133	3000	80	2748	2115	Diffused

**Oh!\_S E27** | 220-240 V

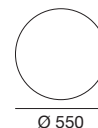
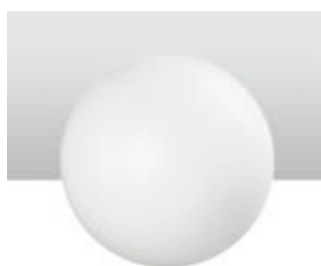

Product	Source
□ 12126	E27 1 x 46 W Max Halogen (LED bulbs compatible)

**Finishes**

□ White

# Oh! Smash



Diffusore in polietilene.  
Montatura in policarbonato bianco.

Polyethylene diffuser.  
White polycarbonate mount.

## Oh! Smash\_S E27 | 220-240 V

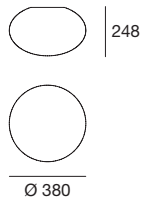

Product	Source
12214	E27 1 x 30 W Max Halogen (LED bulbs compatible)

## Oh! Smash\_S E27 | 220-240 V

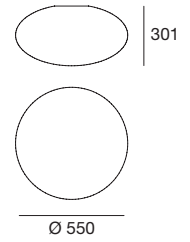

Product	Source
12217	E27 1 x 46 W Max Halogen (LED bulbs compatible)



# Ohps



Diffusore in polietilene.  
Montatura in policarbonato bianco.

Polyethylene diffuser.  
White polycarbonate mount.

## Ohps\_S E27 | 220-240 V

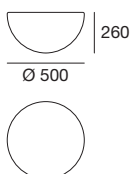

Product	Source
 12386	E27 1 x 30 W Max Halogen (LED bulbs compatible)

## Ohps\_S E27 | 220-240 V

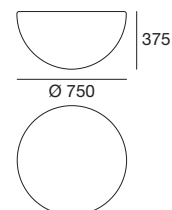

Product	Source
 12387	E27 1 x 46 W Max Halogen (LED bulbs compatible)



### Finishes

 White

### Ceiling & Wall

# One to one

Diffusore in polimetilmetacrilato sabbato.  
Montatura in alluminio verniciato bianco raggrinzante.



46

Sandblasted polymethylmethacrylate diffuser.  
Wrinkle effect white painted aluminium mount.



**One to one\_S** | 220-240 V | arrayLED 8 W DC - 10 W AC

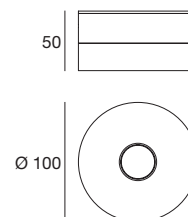
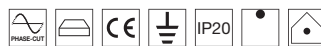

Product	Cct	Cri	lm S	lm D	Optics
7618	3000	80	1082	820	Diffused

#### Accessory Description

**KIT0026** | Phase-cut dimmer (max. 100 W)

# Outlook

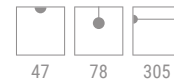

Corpo in alluminio verniciato bianco raggrinzante.  
Diffusore in vetro trasparente.

Body in wrinkle effect white painted aluminium.  
Diffuser in clear glass.

**Outlook\_S** | 220-240 V | arrayLED 8 W DC - 11 W AC

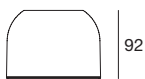
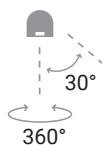

Product	Cct	Cri	lm S	lm D	Optics
8472	3000	90	1082	820	W.Flood (62°)

#### Accessory Description

**KIT0026** | Phase-cut dimmer (max. 100 W)



#### Finishes

White

#### Ceiling & Wall

# Poe

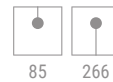

Corpo e montatura in metallo verniciato bianco, nero o grigio raggrinzante, oppure in finitura terracotta. Diffusore in policarbonato satinato.

Body and mount in white, black or wrinkle effect grey painted metal or in terracotta finish. Satin polycarbonate diffuser.



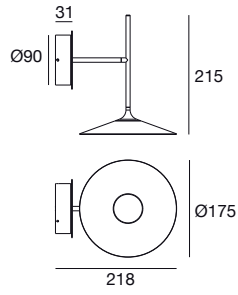

Product	Cct	Cri	lm S	lm D	Optics
8500	3000	90	740	536	Diffused
8501					
8503					
8504					



Finishes



# Polo



Diffusore in polietilene.  
Montatura in policarbonato bianco.

Polyethylene diffuser.  
White polycarbonate mount.





Product	Cct	Cri	Im S	Im D	Optics
9160	3000	80	3568	3222	Diffused

**Accessory Description**

Accessory	Description
KIT0107	Decentralization kit ON/OFF canopy (Ø 80 mm)

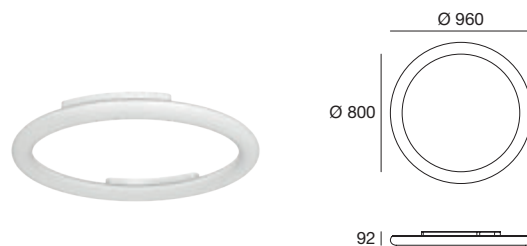

Product	Cct	Cri	Im S	Im D	Optics
9161	3000	80	5966	5118	Diffused

**Accessory Description**

Accessory	Description
KIT0107	Decentralization kit ON/OFF canopy (Ø 80 mm)
KIT0108	Decentralization kit DALI canopy (Ø 160 mm)

**Centrata o decentrata: come preferisci la tua Polo?**

I kit decentramenti on/off e DALI acquistabili a parte ti permettono di sfruttare punti luce decentrati per portare la luce dove preferisci. Oppure, di centrare la lampada rispetto al punto luce stesso.

**Centre or off-centre – how do you want your Polo?**

The separately-purchasable On/Off and DALI decentralisation kits allow you to create off-centre lighting points to have light right where you want it. Alternatively, you can even centre the fixture in relation to the light point itself.



**Direct mounting.**  
No decentralization kit required.

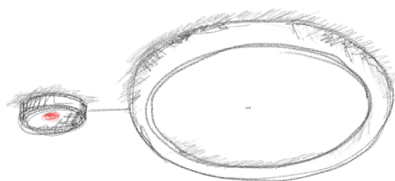

**KIT0108**  
Decentralization kit DALI canopy (Ø 160)

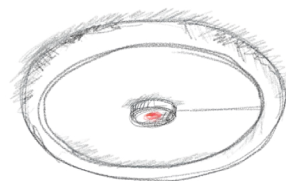

**KIT0107**  
Decentralization kit ON/OFF canopy (Ø 80)

**Finishes**

White

# Regolo

Corpo in alluminio verniciato bianco o marrone raggrinzante.  
Diffusore in policarbonato sabbiato.

Body in white or brown wrinkle effect painted aluminium.  
Sandblasted polycarbonate diffuser.





**Regolo 160** | 220-240 V | topLED 16 W DC - 18 W AC



Product	Cct	Cri	Im S	Im D	Optics
9035	3000	90	2109	1486	Diffused
9036					
9037					

**Regolo 240** | 220-240 V | topLED 22 W DC - 24 W AC

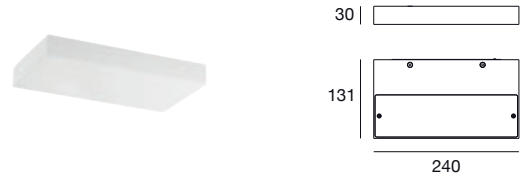

Product	Cct	Cri	Im S	Im D	Optics
9040	3000	90	2746	2030	Diffused
9041					
9042					

**Regolo 320** | 220-240 V | topLED 33 W DC - 36 W AC

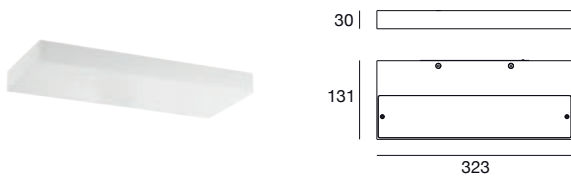

Product	Cct	Cri	Im S	Im D	Optics
9045	3000	90	4183	2912	Diffused
9046					
9047					

**Finishes**

White    Black    Anodised Aluminium

# Reiki

Corpo in alluminio verniciato bianco o grigio antracite  
raggrinzante. Diffusore in polimetilmetacrilato sabbato.

Body in wrinkled white or anthracite grey painted aluminium.  
Sandblasted polymethylmethacrylate diffuser.



Reiki | 220-240 V | topLED 24 W DC - 28 W AC



Product	Cct	Cri	lm S	lm D	Optics
9296M	2700	90	3100	1565	Diffused
9297M					
9296	3000	90	3200	1671	Diffused
9297					

Reiki | 220-240 V | topLED 36 W DC - 42 W AC



Product	Cct	Cri	lm S	lm D	Optics
9298M	2700	90	4400	2821	Diffused
9299M					
9298	3000	90	4500	2938	Diffused
9299					

Finishes

White Anthracite Grey

# Rose



89

Corpo in metallo verniciato bianco raggrinzante.  
Diffusore in polietilene.

Body in wrinkle effect white painted metal.  
Polyethylene diffuser.



Rose\_S | 220-240 V | E27

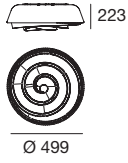

Product	Source
<input type="checkbox"/> 7656	E27 2 x 46 W Max Halogen (LED bulbs compatible)

Rose\_S | 220-240 V | E27

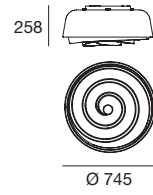

Product	Source
<input type="checkbox"/> 7658	E27 3 x 46 W Max Halogen (LED bulbs compatible)

Finishes

White

# Satori



90

Corpo in alluminio verniciato bianco o nero raggrinzante. Diffusore in policarbonato opalino. Montatura in metallo verniciato bianco o nero raggrinzante.

Body in white or black wrinkle effect painted aluminium. Opal polycarbonate diffuser. Wrinkle effect black or white painted metal mount.



Satori\_W | 220-240 V | topLED 17 W DC - 20 W AC



DALI PUSH

Product	Cct	Cri	lm S	lm D	Optics
<b>9180M</b>	2700	90	2622	1689	Diffused
<b>9181M</b>					
<b>9180</b>	3000	90	2780	1790	Diffused
<b>9181</b>					

ON/OFF

Product	Cct	Cri	lm S	lm D	Optics
<b>9174M</b>	2700	90	2622	1689	Diffused
<b>9175M</b>					
<b>9174</b>	3000	90	2780	1790	Diffused
<b>9175</b>					

Satori\_W | 220-240 V | topLED 24 W DC - 27 W AC



DALI PUSH

Product	Cct	Cri	lm S	lm D	Optics
<b>9182M</b>	2700	90	3749	2370	Diffused
<b>9183M</b>					
<b>9182</b>	3000	90	3966	2512	Diffused
<b>9183</b>					

ON/OFF

Product	Cct	Cri	lm S	lm D	Optics
<b>9176M</b>	2700	90	3749	2370	Diffused
<b>9177M</b>					
<b>9176</b>	3000	90	3966	2512	Diffused
<b>9177</b>					

Satori\_W | 220-240 V | topLED 35 W DC - 38 W AC



DALI PUSH

Product	Cct	Cri	lm S	lm D	Optics
<b>9184M</b>	2700	90	5624	3106	Diffused
<b>9185M</b>					
<b>9184</b>	3000	90	5950	3304	Diffused
<b>9185</b>					

ON/OFF

Product	Cct	Cri	lm S	lm D	Optics
<b>9178M</b>	2700	90	5624	3106	Diffused
<b>9179M</b>					
<b>9178</b>	3000	90	5950	3304	Diffused
<b>9179</b>					

Finishes

White Black





**Satori\_S** | 220-240 V | topLED 25 W DC - 28 W AC



Product	Cct	Cri	lm S	lm D	Optics
<b>9189M</b>	2700	90	3933	2288	Diffused
<b>9190M</b>					
<b>9189</b>	3000	90	4171	2425	Diffused
<b>9190</b>					

**Satori\_S** | 220-240 V | topLED 36 W DC - 44 W AC

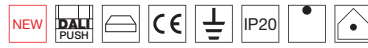

Product	Cct	Cri	lm S	lm D	Optics
<b>9191M</b>	2700	90	5245	3387	Diffused
<b>9192M</b>					
<b>9191</b>	3000	90	5562	3590	Diffused
<b>9192</b>					



**Finishes**

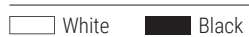

# Sinfonia

Corpo in alluminio verniciato bianco o nero raggrinzante, oppure nelle finiture galvaniche cromo e oro spazzolato. Diffusore in polimetilmetacrilato.

Body in wrinkle effect white or black painted aluminium, or in the galvanic chrome and brushed gold finishes. Diffuser in polymethylmethacrylate.



Rossini\_S | 220-240 V | topLED 5 W DC - 6 W AC

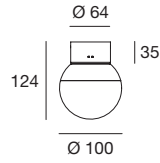

Product	Cct	Cri	lm S	lm D	Optics
9210	3000	90	627	468	Diffused
9211					
9212					
9214					

Vivaldi\_W | 220-240 V | topLED 5 W DC - 6 W AC

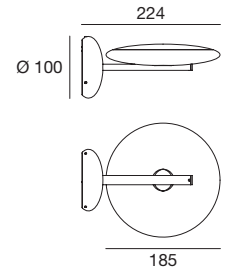

Product	Cct	Cri	lm S	lm D	Optics
9235	3000	90	523	299	Diffused
9236					
9237					
9239					



Finishes



Ceiling & Wall

# Skinny

Corpo in alluminio anodizzato o verniciato bianco raggrinzante. Diffusore in polimetilmetacrilato con microincisioni al laser (OptiLight Technology™).

Body in anodised aluminium or painted wrinkle effect white. Polymethylmethacrylate diffuser with laser micro-engraving (OptiLight Technology™).



**Skinny** | 220-240 V | topLED 12 W DC - 14 W AC

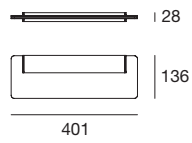

Product	Cct	Cri	lm S	lm D	Optics
□ 7908	3000	90	1515	956	Diffused
■ 7909					

**Skinny** | 220-240 V | topLED 24 W DC - 28 W AC

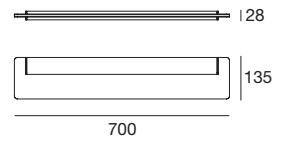

Product	Cct	Cri	lm S	lm D	Optics
□ 7910	3000	90	3032	1968	Diffused
■ 7911					

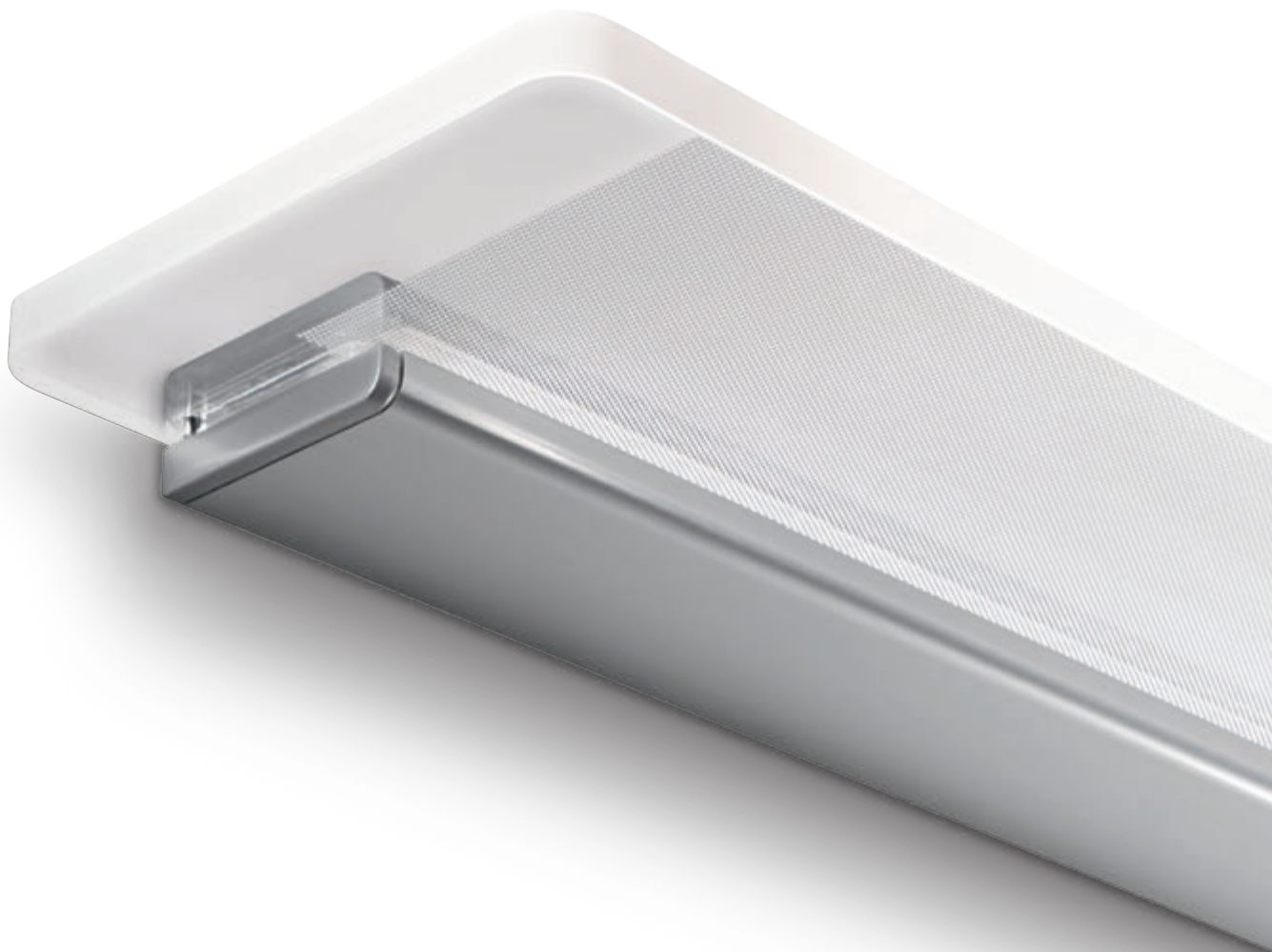

**Finishes**

□ White   ■ Anodised Aluminium

# Snake

Corpo tubolare in Santoprene™ bianco o nero opaco.  
Diffusore in policarbonato satinato. Montatura in  
alluminio verniciato bianco o nero raggrinzante.

Tubular body in matt white or black Santoprene™.  
Satin polycarbonate diffuser. White or black  
wrinkle effect painted aluminium mount.



**Snake\_W1** | topLED 1,5 W DC 500 mA



Product	Cct	Cri	Im S	Im D	Optics
7223	3000	90	178	125	Diffused
7224					

**Electronics Description**

<b>KIT73</b>	ON/OFF Driver (max. 10 W)
<b>KIT72</b>	ON/OFF Driver (max. 20 W)

**Snake\_W1** | 220-240 V | topLED 1,5 W DC - 2 W AC

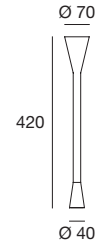

Product	Cct	Cri	Im S	Im D	Optics
7220	3000	90	178	125	Diffused
7221					

**Snake\_W1 Switch** | 220-240 V | topLED 1,5 W DC - 2 W AC

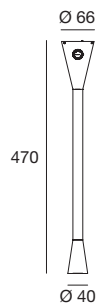

Product	Cct	Cri	Im S	Im D	Optics
7232	3000	90	178	125	Diffused
7233					



On/Off switch



**Finishes**

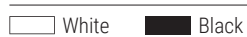





**Snake\_W2** | topLED 1,5 W DC 500 mA



Product	Cct	Cri	Im S	Im D	Optics
White 7229	3000	90	178	117	Diffused
Black 7230					

**Electronics Description**

<b>KIT73</b>	ON/OFF Driver (max. 10 W)
<b>KIT72</b>	ON/OFF Driver (max. 20 W)

**Snake\_W3** | 220-240 V | topLED 1,5 W DC - 2 W AC

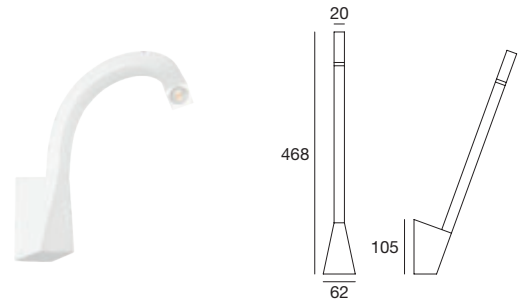

Product	Cct	Cri	Im S	Im D	Optics
White 7226	3000	90	178	117	Diffused
Black 7227					

**Snake\_W3 Switch** | 220-240 V | topLED 1,5 W DC - 2 W AC

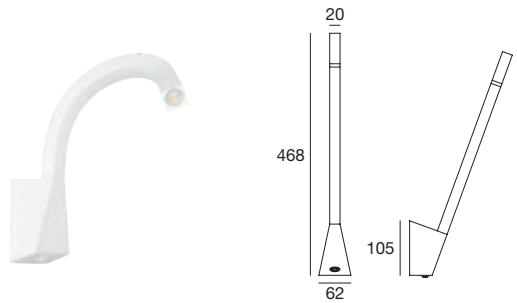

Product	Cct	Cri	Im S	Im D	Optics
White 7234	3000	90	178	117	Diffused
Black 7235					

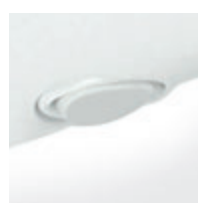

On/Off switch

**Finishes**

- White
- Black

# Squash

Diffusore in polietilene.  
Montatura in metallo verniciato bianco raggrinzante.



Polyethylene diffuser.  
Mount in white painted metal with wrinkle effect.



## Squash\_S | 220-240 V | topLED 9 W AC



Product	Cct	Cri	lm S	lm D	Optics
7951	3000	90	870	830	Diffused

## Squash\_S | 220-240 V | topLED 19 W AC



Product	Cct	Cri	lm S	lm D	Optics
7626	3000	90	2364	1954	Diffused

# Straight



103

Corpo in alluminio verniciato bianco o nero  
raggrinzante, oppure in finitura galvanica cromo.  
Diffusore in policarbonato. Montatura in ABS.

Body in wrinkle effect white or black painted  
aluminium or in galvanic chrome finish.  
Polycarbonate diffuser. ABS mount.

**Straight\_W** | 220-240 V | topLED 11 W DC - 13 W AC

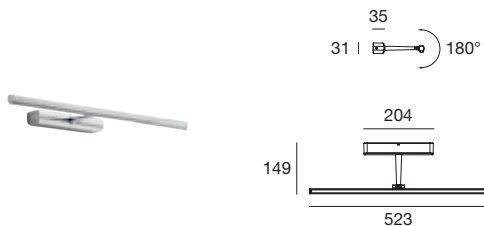

Product	Cct	Cri	lm S	lm D	Optics
8208	2700	90	1354	528	Diffused
8210					
8265					

**Straight\_W** | 220-240 V | topLED 15 W DC - 19 W AC

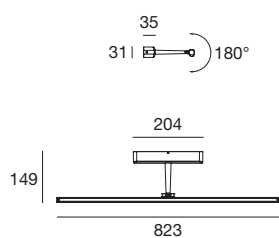

Product	Cct	Cri	lm S	lm D	Optics
8209	2700	90	1957	756	Diffused
8211					
8266					



## Finishes

White Black Chrome

Ceiling & Wall

219

# Tara

Corpo in alluminio verniciato bianco o nero raggrinzante.  
Diffusore in polimetilmetacrilato sabbato.

Body in white or black wrinkle effect painted aluminium.  
Sandblasted polymethylmethacrylate diffuser.

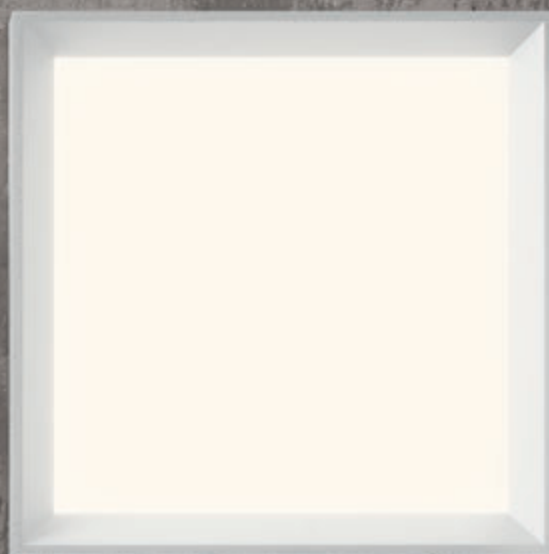

**Tara\_R** | 220-240 V | topLED 17 W DC - 21 W AC

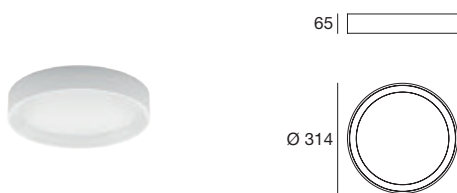

Product	Cct	Cri	lm S	lm D	Optics
□ 8334	3000	90	2208	1764	Diffused
■ 8335					

**Tara\_Q** | 220-240 V | topLED 18 W DC - 21 W AC

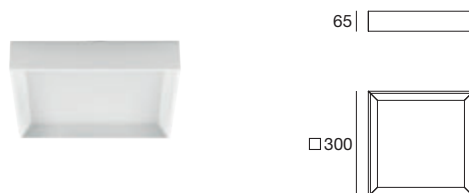

Product	Cct	Cri	lm S	lm D	Optics
□ 8325	3000	90	2336	1360	Diffused
■ 8326					

**Tara\_R** | 220-240 V | topLED 27 W DC - 31 W AC

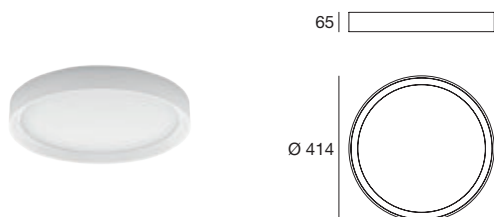

Product	Cct	Cri	lm S	lm D	Optics
□ 8337	3000	90	3285	2466	Diffused
■ 8338					

**Tara\_Q** | 220-240 V | topLED 25 W DC - 31 W AC



Product	Cct	Cri	lm S	lm D	Optics
□ 8328	3000	90	3228	1898	Diffused
■ 8329					

**Tara\_R** | 220-240 V | topLED 41 W DC - 46 W AC

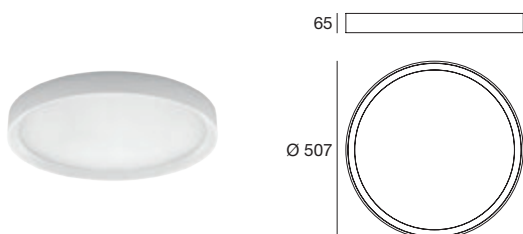

Product	Cct	Cri	lm S	lm D	Optics
□ 8340	3000	90	4883	3525	Diffused
■ 8341					

**Tara\_Q** | 220-240 V | topLED 39 W DC - 45 W AC

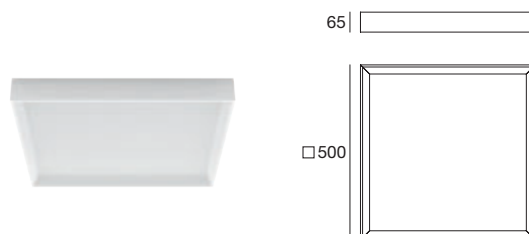

Product	Cct	Cri	lm S	lm D	Optics
□ 8331	3000	90	4700	2720	Diffused
■ 8332					

**Finishes**

□ White ■ Black



**Tara\_R** | 220-240 V | topLED 17 W DC - 23 W AC

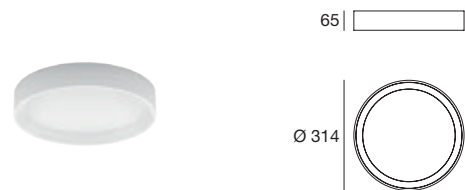
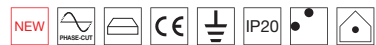

Product	Cct	Cri	lm S	lm D	Optics
CA004DWHMDI	2700	90	2054	1641	Diffused
CA004DBBMDI					

Accessory	Description
KIT0026	Phase-cut Dimmer (4 art. / max. 100 W)

**Tara\_Q** | 220-240 V | topLED 18 W DC - 23 W AC

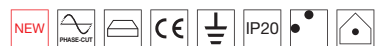

Product	Cct	Cri	lm S	lm D	Optics
CA001DWHMDI	2700	90	2173	1265	Diffused
CA001DBBMDI					

Accessory	Description
KIT0026	Phase-cut Dimmer (4 art. / max. 100 W)

Tara\_R | 220-240 V | topLED 27 W DC - 33 W AC

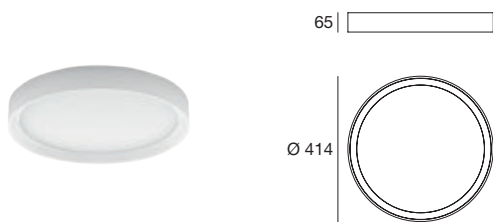

Product	Cct	Cri	Im S	Im D	Optics
CA005DWHMDI	2700	90	3056	2294	Diffused
CA005DBBMDI					

Accessory Description

KIT0026 | Phase-cut Dimmer (3 art. / max. 100 W)

Tara\_R | 220-240 V | topLED 41 W DC - 45 W AC

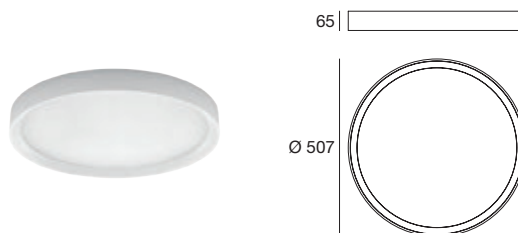
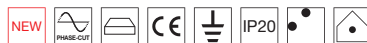

Product	Cct	Cri	Im S	Im D	Optics
CA006DWHMDI	2700	90	4542	3280	Diffused
CA006DBBMDI					

Accessory Description

KIT0026 | Phase-cut Dimmer (2 art. / max. 100 W)

Tara\_Q | 220-240 V | topLED 25 W DC - 33 W AC

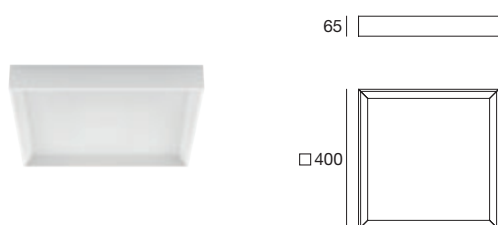

Product	Cct	Cri	Im S	Im D	Optics
CA002DWHMDI	2700	90	3003	1765	Diffused
CA002DBBMDI					

Accessory Description

KIT0026 | Phase-cut Dimmer (3 art. / max. 100 W)

Tara\_Q | 220-240 V | topLED 39 W DC - 45 W AC

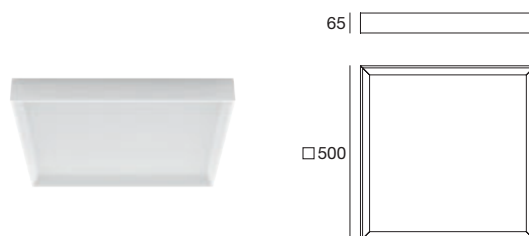

Product	Cct	Cri	Im S	Im D	Optics
CA003DWHMDI	2700	90	4372	2530	Diffused
CA003DBBMDI					

Accessory Description

KIT0026 | Phase-cut Dimmer (2 art. / max. 100 W)

Finishes

White Black





Tara\_B | 220-240 V | topLED 38 W DC - 44 W AC

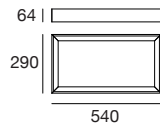

Product	Cct	Cri	lm S	lm D	Optics
CA007DWHMDI	2700	90	4354	2756	Diffused
CA007DBBMDI					
9015	3000	90	4680	2963	Diffused
9016					

Accessory Description

KIT0026 | Phase-cut Dimmer (1-2 art. / max. 100 W)

Tara\_B | 220-240 V | topLED 24 W DC - 28 W AC

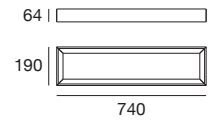

Product	Cct	Cri	lm S	lm D	Optics
CA008DWHMDI	2700	90	3304	1833	Diffused
CA008DBBMDI					
9018	3000	90	3552	1971	Diffused
9019					

Accessory Description

KIT0026 | Phase-cut Dimmer (1-3 art. / max. 100 W)

Tara\_B | 220-240 V | topLED 38 W DC - 42 W AC

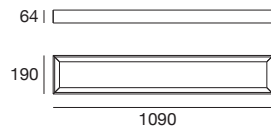

Product	Cct	Cri	lm S	lm D	Optics
CA009DWHMDI	2700	90	5036	2555	Diffused
CA009DBBMDI					
9021	3000	90	5414	2746	Diffused
9022					

Accessory Description

KIT0026 | Phase-cut Dimmer (1-2 art. / max. 100 W)

Finishes

White Black





**Tara Maxi** | 220-240 V | topLED 51 W DC - 58 W AC



	Product	Cct	Cri	lm S	lm D	Optics
	CA010DWHMDI	2700	90	5850	4343	Diffused
	CA010DBBMDI					
	9024	3000	90	6288	4669	Diffused
	9025					

**Accessory Description**

**KIT0026** | Phase-cut Dimmer (1 art. / max. 100 W)

**Tara Mega** | 220-240 V | topLED 66 W DC - 76 W AC

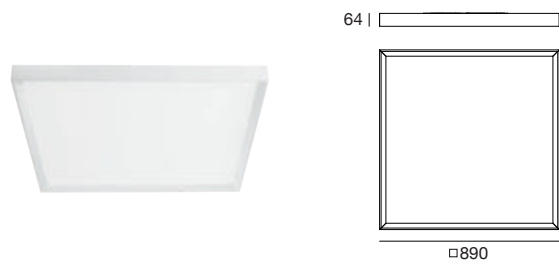

	Product	Cct	Cri	lm S	lm D	Optics
	CA011DWHMDI	2700	90	7300	5476	Diffused
	CA011DBBMDI					
	9027	3000	90	7848	5887	Diffused
	9028					

**Accessory Description**

**KIT0026** | Phase-cut Dimmer (1 art. / max. 100 W)

**Finishes**

White Black

**Ceiling & Wall**

# Triad

Montatura in metallo verniciato bianco raggrinzante, bianco lucido oppure in finitura wengè. Diffusore in vetro sabbato.

Metal mount painted wrinkle effect white, glossy white or in wengè finish. Sandblasted glass diffuser.



**Triad 2.0** | 220-240 V | topLED 9 W DC - 12 W AC

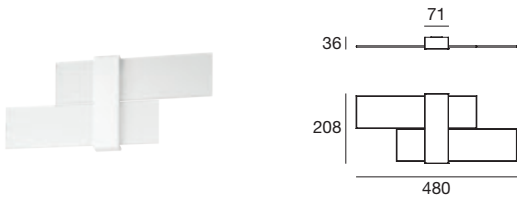

Product	Cct	Cri	lm S	lm D	Optics
90335	3000	80	1290	957	Diffused

**Triad 2.0** | 220-240 V | topLED 21 W DC - 21 W AC

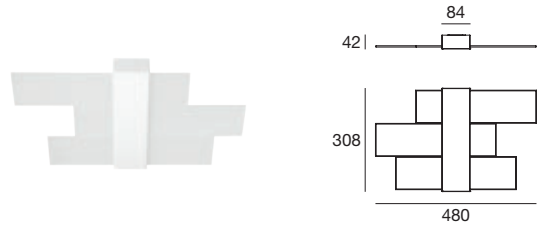

Product	Cct	Cri	lm S	lm D	Optics
90336	3000	80	2256	1674	Diffused

**Triad 2.0** | 220-240 V | topLED 32 W DC - 36 W AC

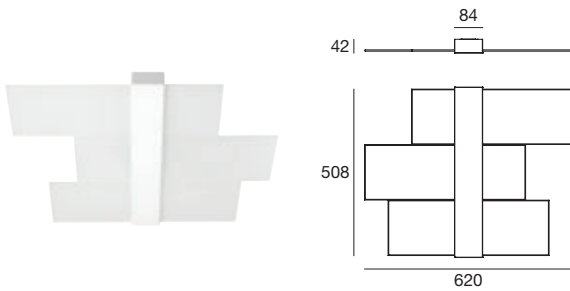

Product	Cct	Cri	lm S	lm D	Optics
90337	3000	80	4316	2871	Diffused

**Finishes**

White

**Ceiling & Wall**



Triad\_S | 220-240 V | E27

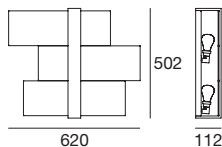
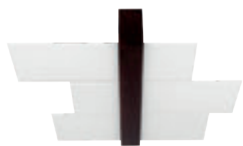

Product	Source
90208	E27
90230	2 x 57 W Max Halogen (LED bulbs compatible)

Triad\_S | 220-240 V | E27

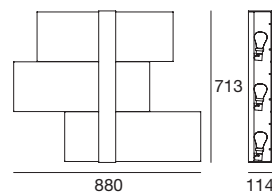

Product	Source
90209	E27
90231	3 x 57 W Max Halogen (LED bulbs compatible)

Triad\_W | 220-240 V | E27

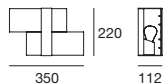

Product	Source
90206	E27
90228	1 x 57 W Max Halogen (LED bulbs compatible)

Triad\_W | 220-240 V | E27

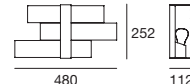

Product	Source
90207	E27
90229	1 x 57 W Max Halogen (LED bulbs compatible)

Finishes

White White / Wengè

# TU-Top

Diffusore in polimetilmetacrilato opalino. Tappi di chiusura e montatura in alluminio verniciato bianco raggrinzante.

Diffuser in opal polymethylmethacrylate. Closing caps and mount in wrinkle effect white painted aluminium.





**TU-Top** | 220-240 V | topLED 32 W DC - 36 W AC

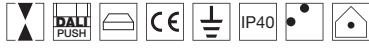

Product	Cct	Cri	lm S	lm D	Optics
□ 8850	3000	80	4764	4108	Diffused

**TU-Top** | 220-240 V | topLED 41 W DC - 48 W AC

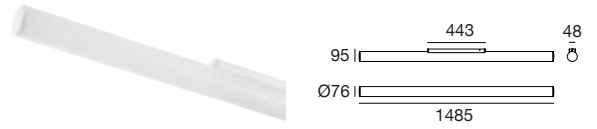
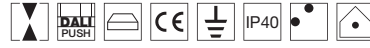

Product	Cct	Cri	lm S	lm D	Optics
□ 8851	3000	80	6234	5370	Diffused



**Finishes**

□ White

# Yo-yo



110

Corpo in alluminio verniciato raggrinzante in varie finiture.  
Diffusore in polimetilmetacrilato opalino.

Body in wrinkle effect painted aluminium in various finishes.  
Diffuser in opal polymethylmethacrylate.



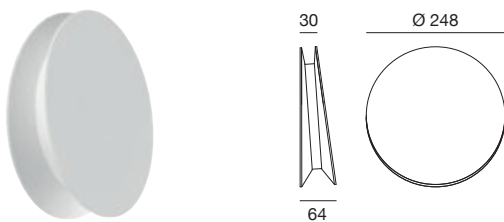

Product	Cct	Cri	lm S	lm D	Optics
9645M	2700	90	3303	1995	Diffused
9646M				917	
9647M				1321	
9648M				957	
9645	3000	90	3552	2168	Diffused
9646				997	
9647				1436	
9648				1040	

**Accessory Description**

**KIT0026** | Phase-cut dimmer (max. 100 W)

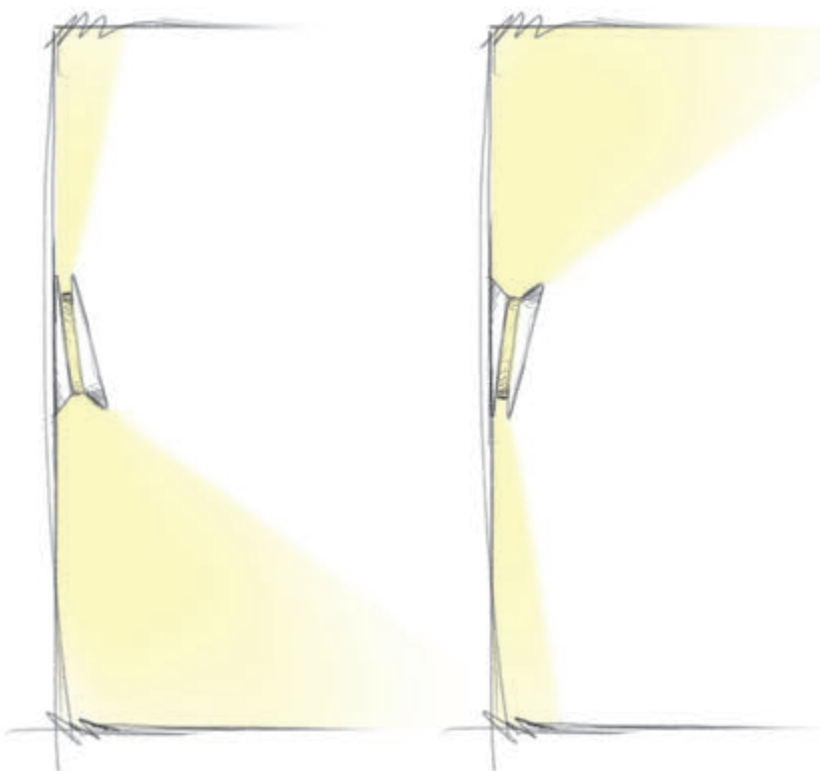

**Luce asimmetrica per illuminare in base alle tue necessità.**

Il disco frontale di Yo-Yo è obliquo. Il risultato è un'emissione variabile: più l'apertura è larga, più luce fuoriesce. Semplice, no? Scegli se girare la lampada verso l'alto o verso il basso, o addirittura sbizzarrirti con la fantasia!

**Asymmetrical light to illuminate according to your needs.**

The front disc of Yo-Yo is oblique. The result is a variable output where the wider the aperture, the more light escapes. Simple, isn't it? Choose whether to turn the lamp upwards, downwards or even let your imagination run wild!

**Finishes**

White Black Grey Ruby Red

# Zig zag

Corpo in alluminio verniciato bianco o nero  
raggrinzante, oppure in finitura galvanica argento.  
Diffusore in vetro sabbato.



112

Body in wrinkle effect white or black painted  
aluminium or in galvanic silver finish.  
Sandblasted glass diffuser.



**Zig zag\_S** | 220-240 V | E27

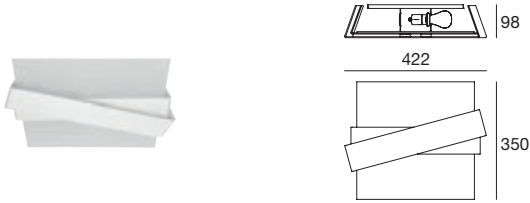

Product	Source
7400	E27
7402	2 x 46 W Max Halogen (LED bulbs compatible)
7401	

**Zig zag\_S** | 220-240 V | E27

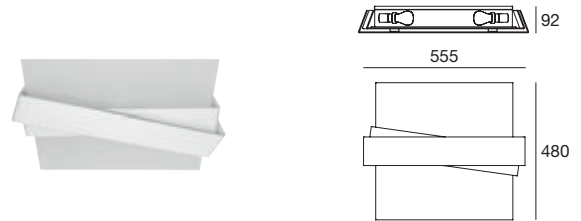

Product	Source
7290	E27
7289	2 x 46 W Max Halogen (LED bulbs compatible)
7291	

**Zig zag\_W** | 220-240 V | E27

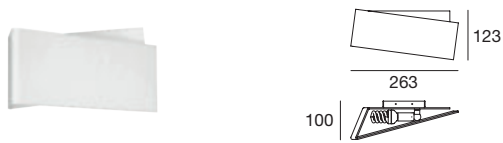

Product	Source
6996	E27
6999	1 x 48 W Max Halogen (3000 k included) (LED bulbs compatible)
7001	

**Zig zag\_W** | 220-240 V | E27



Product	Source
6986	E27
6989	1 x 57 W Max Halogen (LED bulbs compatible)
6990	

**Finishes**

White    Black    Black / White    Anodised Aluminium





**FLOOR &  
TABLE**

# Antigua

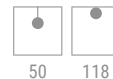

50 118

Diffusore in vetro trasparente con bordo sabbato.  
Elemento centrale, stelo e base in metallo verniciato  
bianco o nero raggrinzante.

Diffuser in clear glass with sandblasted edge.  
Central element, stem and base in wrinkle  
effect white or black painted metal.









**Antigua\_FL** | 220-240 V | stripLED 32 W DC - 39 W AC

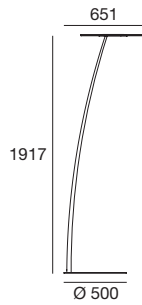

3 m



Product	Cct	Cri	lm S	lm D	Optics
 9315	3000	90	2796	2000	Diffused
 9316					

**Finishes**

 White

# Birba

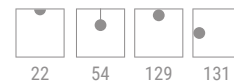

Corpo in ottone lucido, alluminio lucido o alluminio verniciato bianco raggrinzante. Base in metallo verniciato bianco raggrinzante.

Body in polished brass, polished or wrinkle effect white painted aluminium. Base in wrinkle effect white painted metal.



**Birba\_TAB** | 220-240 V | E27

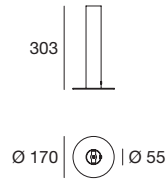

Product	Source
9463	E27
9465	Max 22 W LED Bulb (not included)
9466	



**Birba\_FL** | 220-240 V | E27

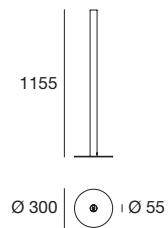

Product	Source
9475	E27
9477	Max 22 W LED Bulb (not included)
9478	

**Birba\_FL** | 220-240 V | E27

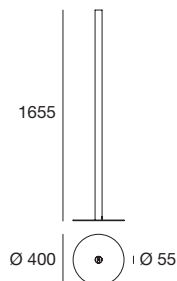

Product	Source
9469	E27
9471	Max 22 W LED Bulb (not included)
9472	

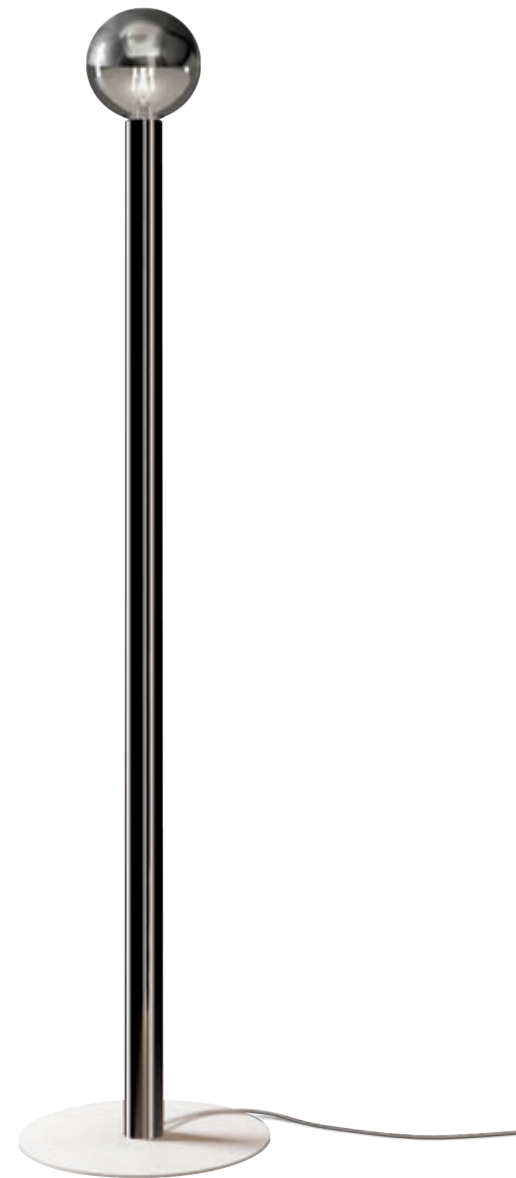

**Finishes**

- White
- Polished Brass
- Polished Aluminium

# Camping

Corpo in alluminio verniciato raggrinzante in varie finiture.  
Diffusore in polimetilmetacrilato trasparente.

Body in wrinkle effect painted aluminium in various finishes.  
Diffuser in clear polymethylmethacrylate.



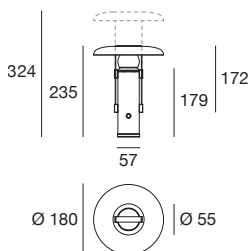

Product	Cct	Cri	lm S	lm D	Optics
9650	1700-4000	90	200-370	99-140	Diffused
9651					
9652					



Carica completa in 3,5 h. Caricabatteria incluso.  
Full charge in 3,5 h. Charger included.

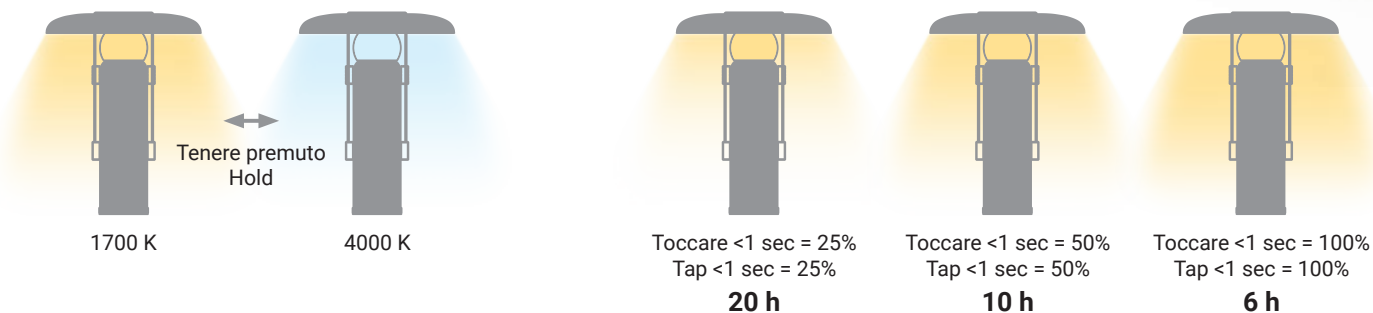

Finishes



# Dama

Corpo in metallo verniciato raggrinzante in varie finiture.

Body in painted metal with wrinkle effect in various finishes.



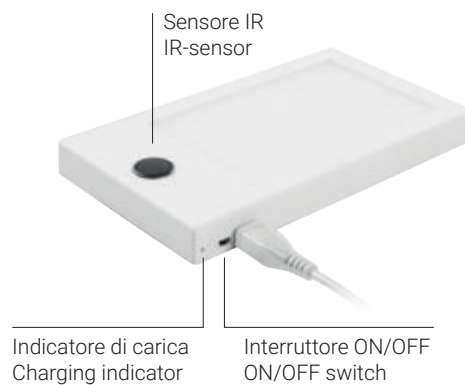

- Sorgente ad installazione magnetica
- Interruttore ON/OFF con sensore IR attivato dal movimento delle mani
- Batteria al litio 3500 mAh
- Durata della batteria  $\geq 8$  h
- Tempo totale di ricarica 4,5 h
- Vita della batteria: cicli di carica e scarica  $\geq 1000$  volte
- Cavo USB incluso

#### Modalità di ricarica USB

Modalità ricarica: indicatore ROSSO  
Carica completa: indicatore VERDE

#### USB charging mode

Charging time: RED indicator  
Full of charging: GREEN indicator

- Simple magnetic installation source
- ON/OFF switch with hand motion activated IR-sensor
- Lithium battery 3500 mAh
- Working time  $\geq 8$  h
- Charging time 4,5 h
- Battery life: cycle charge and discharge  $\geq 1000$  times
- USB cable included









Dama | topLED 1.8 W DC 5 V

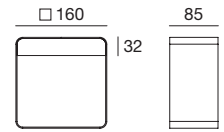
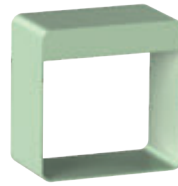

Product	Cct	Cri	Im S	Im D	Optics
9345	3000	80	110	94	Diffused
9346					
9347					
9349					
9350					
9351					



Finishes



Floor & Table

# Dubcolor

Corpo in metallo verniciato raggrinzante in varie finiture.  
Diffusore in polimetilmetacrilato satinato.

Body in painted metal with wrinkle effect in various finishes.  
Satin-finish polymethylmethacrylate diffuser.



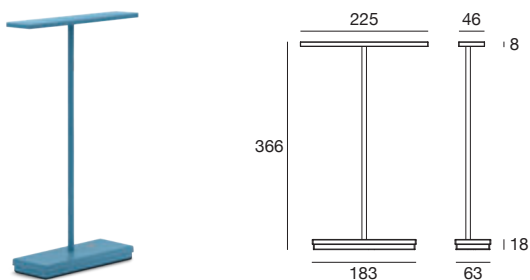

Product	Cct	Cri	lm S	lm D	Optics
9595	1700-4000	90	200-370	165-207	Diffused
9596					
9597					
9598					
9599					
9600					



Carica completa in 3,5 h. Caricabatteria incluso.  
Full charge in 3,5 h. Charger included.

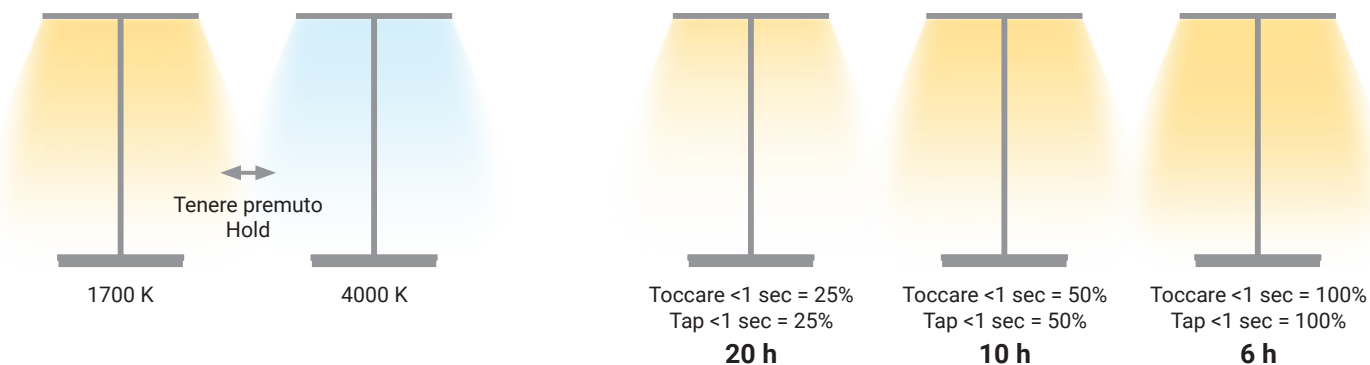

Finishes



Floor & Table

# Dubligh

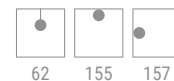

Corpo in metallo verniciato bianco raggrinzante.  
Diffusore in polimetilmetacrilato satinato.

Body in wrinkle effect white painted metal.  
Satin-finish polymethylmethacrylate diffuser.



Dublight\_FL | 220-240 V | topLED 24 W DC - 28 W AC

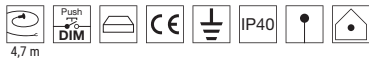

4,7 m

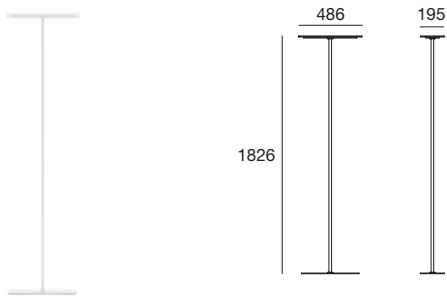

Product	Cct	Cri	Im S	Im D	Optics
7496	3000	80	3148	2149	Diffused

Dublight\_TAB | 220-240 V | topLED 6 W DC - 7 W AC



2,8 m

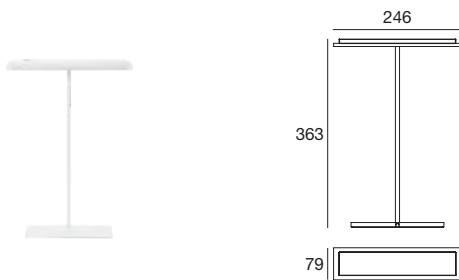

Product	Cct	Cri	Im S	Im D	Optics
7495	3000	90	710	515	Diffused

Dublight\_C TAB | 220-240 V | topLED 6 W DC - 8 W AC



2,8 m

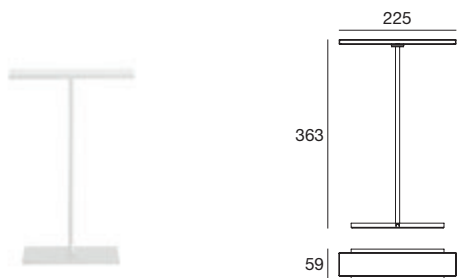

Product	Cct	Cri	Im S	Im D	Optics
7887	3000	90	710	543	Diffused
7888					



DUBLIGHT\_TAB vs DUBLIGHT\_C TAB



DUBLIGHT\_TAB  
Satin PMMA diffuser  
Diffused emission



DUBLIGHT\_C TAB  
Direct emission

Finishes

White Black

# Gemini

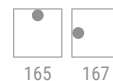

165 167

Corpo in grés nelle finiture statuarietto o nero greco.  
Diffusore in polimetilmetacrilato satinato.  
Base in metallo verniciato bianco raggrinzante.

Stoneware body in statuarietto or nero greco finishes.  
Satin-finish polymethylmethacrylate diffuser.  
Base in wrinkle effect white painted metal.



**Gemini\_TAB** | 220-240 V | topLED 8 W DC - 9 W AC

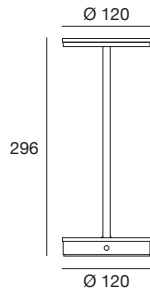

Product	Cct	Cri	lm S	lm D	Optics
■ 9678M	2700	90	839	590	Diffused
■ 9679M					
■ 9678	3000	90	912	641	Diffused
■ 9679					



**Finishes**

- Nero greco
- Statuarietto

# Halfpipe 2

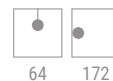

64 172

Corpo in alluminio lucido o verniciato bianco o nero raggrinzante. Diffusore in policarbonato. Base in metallo verniciato bianco o nero raggrinzante.

Body in polished or wrinkle effect white or black painted aluminium. Polycarbonate diffuser. Base in wrinkle effect white or black painted metal.





**Halfpipe 2\_FL** | 220-240 V | topLED 32 W DC - 35 W AC

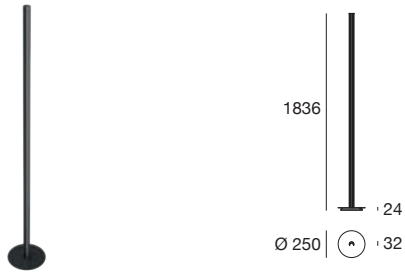

Product	Cct	Cri	lm S	lm D	Optics
9815	3000	90	3590	1773	Diffused
9816					
9817					

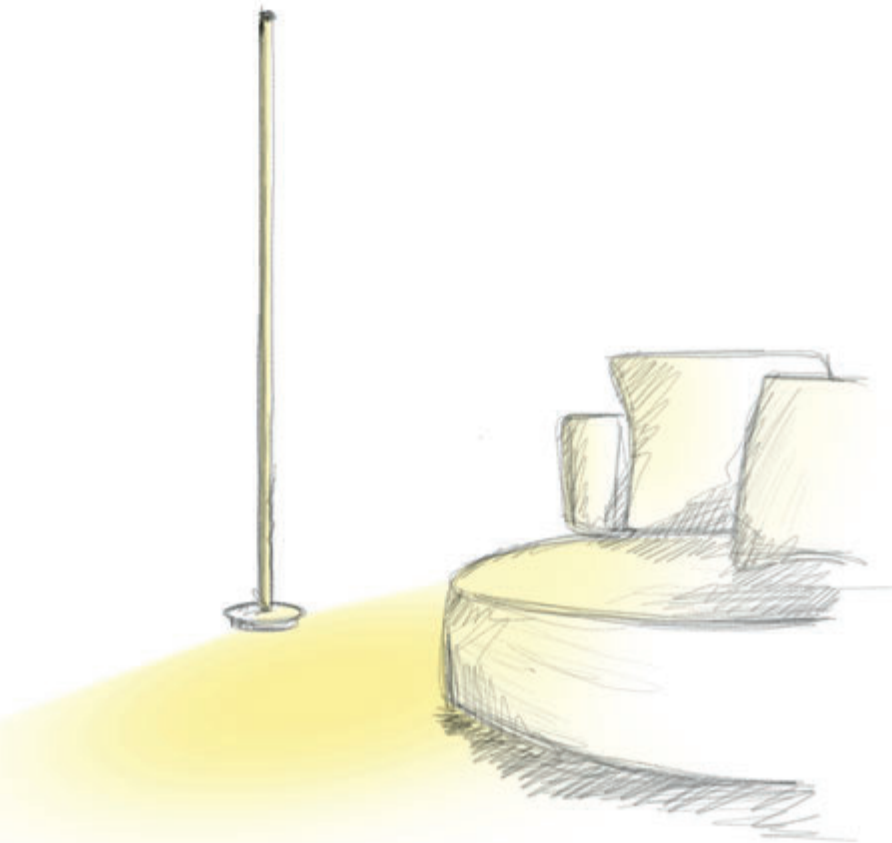

**Finishes**

White Black Polished Aluminium





# Joshua

Testa orientabile in alluminio verniciato bianco o nero raggrinzante. Diffusore in polimetilmetacrilato opalino. Stelo e base in metallo verniciato bianco o nero raggrinzante.



Adjustable head in white or black wrinkle effect painted aluminium. Diffuser in opal polymethylmethacrylate. Stem and base in wrinkle effect white or black painted metal.



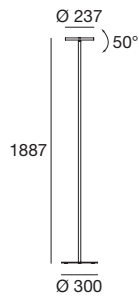

**Joshua** | 220-240 V | topLED 20 W DC - 25 W AC



Product	Cct	Cri	lm S	lm D	Optics
 <b>8365</b>	3000	80	2687	2375	Diffused
 <b>8366</b>					

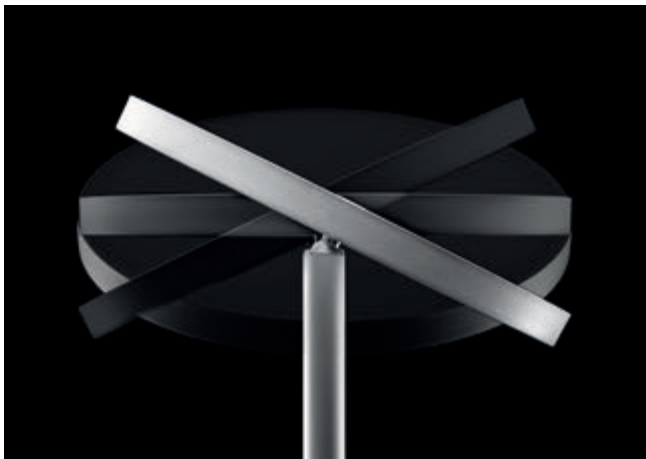

**Finishes**

 White  Black

# Oh!

Diffusore in polietilene.  
Base in policarbonato bianco.

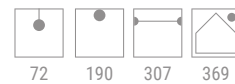

Polyethylene diffuser.  
White polycarbonate base.



Oh!\_FL E27 | 220-240 V



Product	Source
<input type="checkbox"/> 12100	E27 1 x 30 W Max Halogen (LED bulbs compatible)

Oh!\_FL E27 | 220-240 V

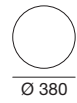

Product	Source
<input type="checkbox"/> 12102	E27 1 x 46 W Max Halogen (LED bulbs compatible)

Oh!\_FL E27 | 220-240 V

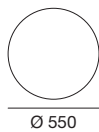

Product	Source
<input type="checkbox"/> 12104	E27 1 x 46 W Max Halogen (LED bulbs compatible)

Oh!\_FL E27 | 220-240 V

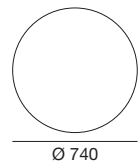

Product	Source
<input type="checkbox"/> 12106	E27 1 x 57 W Max Halogen (LED bulbs compatible)

# Oh! Smash

Diffusore in polietilene.  
Base in policarbonato bianco.



Polyethylene diffuser.  
White polycarbonate base.



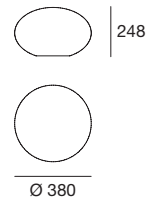

## Oh! Smash\_FL E27 | 220-240 V

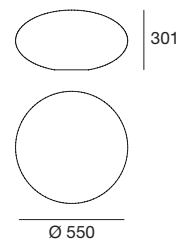

Product	Source
 12215	E27 1 x 30 W Max Halogen (LED bulbs compatible)

## Oh! Smash\_FL E27 | 220-240 V



Product	Source
 12218	E27 1 x 46 W Max Halogen (LED bulbs compatible)



# Ohps



Diffusore in polietilene.  
Base in policarbonato bianco.

Polyethylene diffuser.  
White polycarbonate base.

## Ohps\_FL E27 | 220-240 V

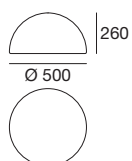

Product	Source
<input type="checkbox"/> 12380	E27 1 x 30 W Max Halogen (LED bulbs compatible)

## Ohps\_FL E27 | 220-240 V

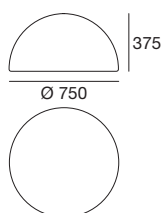

Product	Source
<input type="checkbox"/> 12381	E27 1 x 46 W Max Halogen (LED bulbs compatible)



### Finishes

White

Floor & Table

265

# Poe

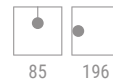

Corpo in metallo verniciato bianco, nero o grigio  
raggrinzante, oppure in finitura terracotta.  
Diffusore in policarbonato satinato.

Body in white, black or wrinkle effect  
grey painted metal or in terracotta finish.  
Satin polycarbonate diffuser.



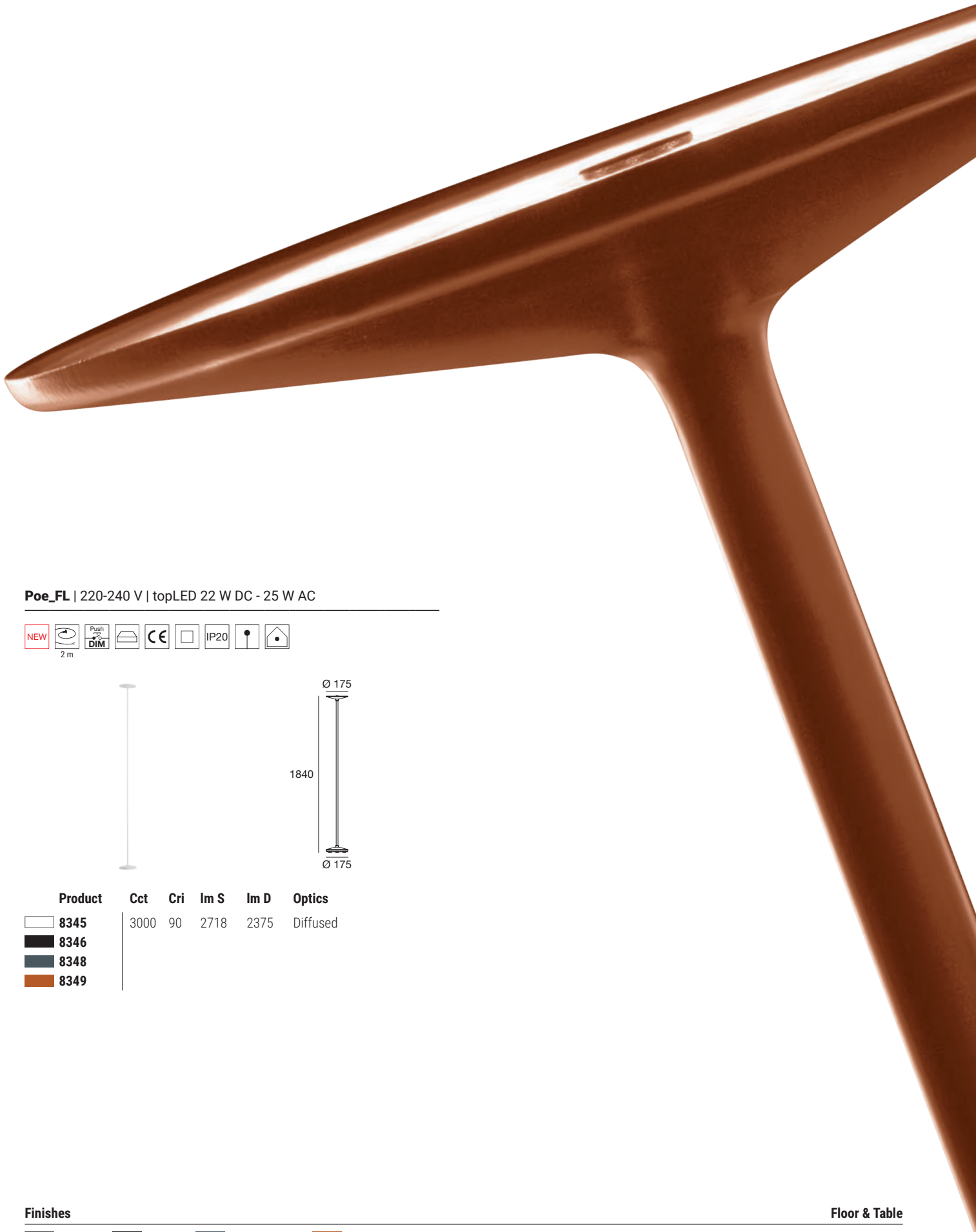

Poe\_FL | 220-240 V | topLED 22 W DC - 25 W AC

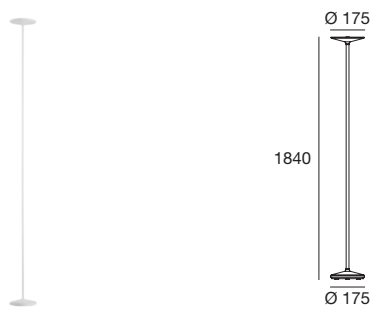

Product	Cct	Cri	lm S	lm D	Optics
8345	3000	90	2718	2375	Diffused
8346					
8348					
8349					

Finishes



# Sinfonia

Corpo in alluminio verniciato bianco o nero raggrinzante, oppure nelle finiture galvaniche cromo e oro spazzolato. Diffusore in polimetilmetacrilato.

Body in wrinkle effect white or black painted aluminium, or in the galvanic chrome and brushed gold finishes. Diffuser in polymethylmethacrylate.



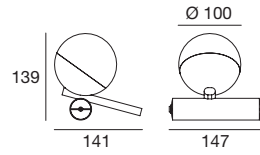

Product	Cct	Cri	lm S	lm D	Optics
9220	3000	90	627	468	Diffused
9221					
9222					
9224					



Push Dim button



Finishes

- White
- Black
- Chrome
- Brushed Gold

# Squash

Corpo in metallo verniciato bianco  
raggrinzante. Diffusore in polietilene.

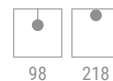

98 218

Body in wrinkle effect white painted  
metal. Polyethylene diffuser.



Squash\_TAB | 220-240 V | topLED 9 W DC - 9 W AC

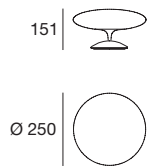

Product	Cct	Cri	Im S	Im D	Optics
□ 7946	3000	90	870	830	Diffused

Squash\_TAB | 220-240 V | topLED 19 W DC - 19 W AC

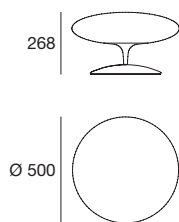

Product	Cct	Cri	Im S	Im D	Optics
□ 7947	3000	90	2364	1750	Diffused

Squash\_FL | 220-240 V | topLED 23 W DC - 25 W AC

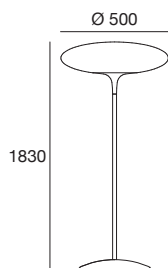

Product	Cct	Cri	Im S	Im D	Optics
□ 7628	3000	90	2522	2310	Diffused



Finishes

□ White







**SYSTEMS**

# Igloo

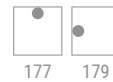

Corpo in alluminio lucido o verniciato bianco o nero  
raggrinzante. Diffusore in polimetilmetacrilato opalino.

Body in polished or wrinkle effect white or black painted  
aluminium. Diffuser in opal polymethylmethacrylate.



## Esci dai soliti schemi installativi!

Puoi creare configurazioni modulari e dimmerabili disponendo a piacere le Igloo\_S DALI, fino a un massimo di 13 lampade collegate.

## Free yourself from the usual installation patterns!

Modular, dimmable configurations can be created by arranging the Igloo\_S DALI lamps at will, with up to a maximum of 13 lamps connected.

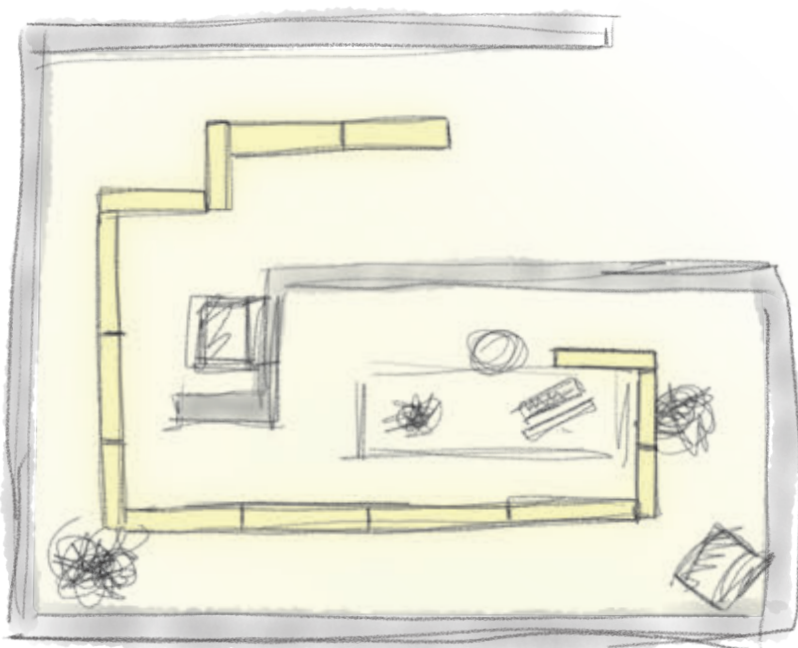
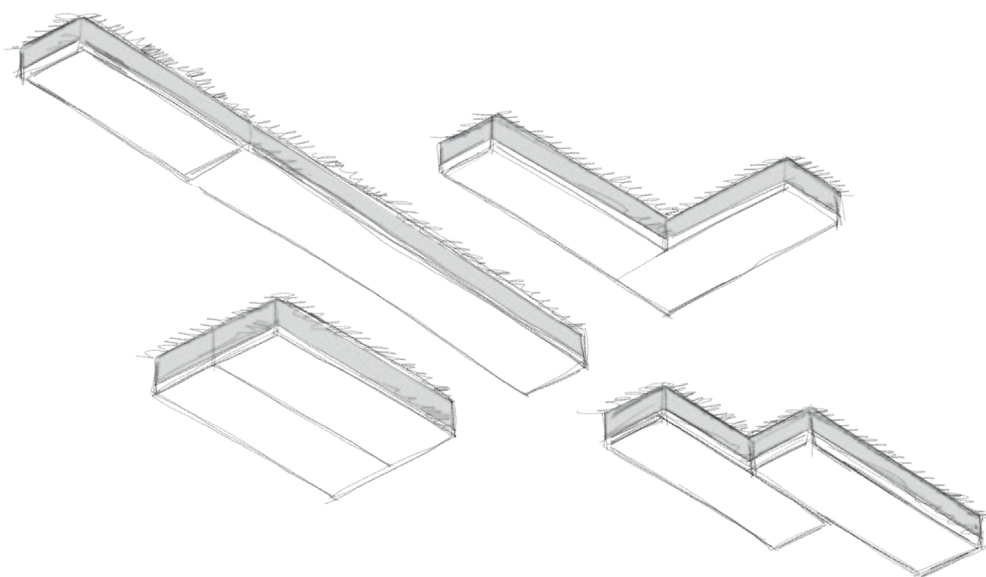
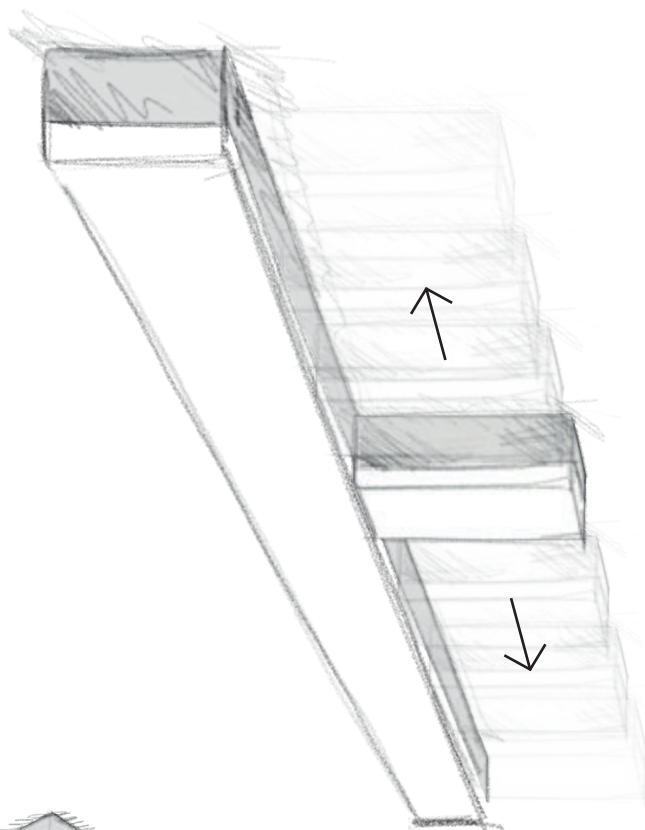

## Componi a piacere configurazioni modulari partendo da un unico punto luce.

Puoi fare linee continue a parete o a soffitto, con le deviazioni e i cambi direzione che preferisci, partendo da un unico punto luce. Comodo, vero?

## From a single light point, compose modular configurations at will.

Create continuous lines on the wall or ceiling, with a choice of deviations and changes in direction, starting from a single point of light. Convenient, right?

**Igloo\_S DALI | 220-240 V | topLED 16 W DC - 20 W AC**



Product	Cct	Cri	Im S	Im D	Optics
9138	3000	90	2306	1316	Diffused
9139					
9140					

Accessory	Description
KIT0096	Junction bracket

**Igloo\_S DALI | 220-240 V | topLED 33 W DC - 36 W AC**

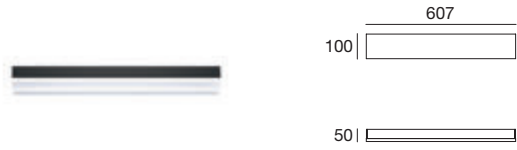

Product	Cct	Cri	Im S	Im D	Optics
9141	3000	90	4470	3139	Diffused
9142					
9143					

Accessory	Description
KIT0098	Junction bracket

**Igloo\_S DALI | 220-240 V | topLED 50 W DC - 53 W AC**

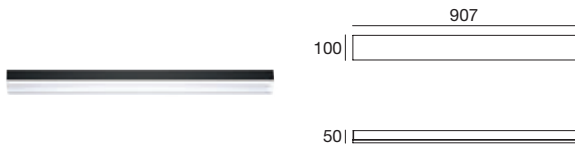

Product	Cct	Cri	Im S	Im D	Optics
9144	3000	90	6636	4833	Diffused
9145					
9146					

Accessory	Description
KIT0099	Junction bracket



# Polo

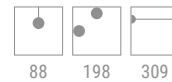

Diffusore in polietilene.  
Montatura in policarbonato bianco.

Polyethylene diffuser.  
White polycarbonate mount.



## Vuoi fare composizioni di cerchi? Abbiamo quello che cerchi!

Grazie alle basette predisposte per il passaggio del cavo di alimentazione da una lampada all'altra, puoi realizzare successioni in serie e illuminare ampi spazi. Puoi persino inserire una Polo dentro un'altra Polo!

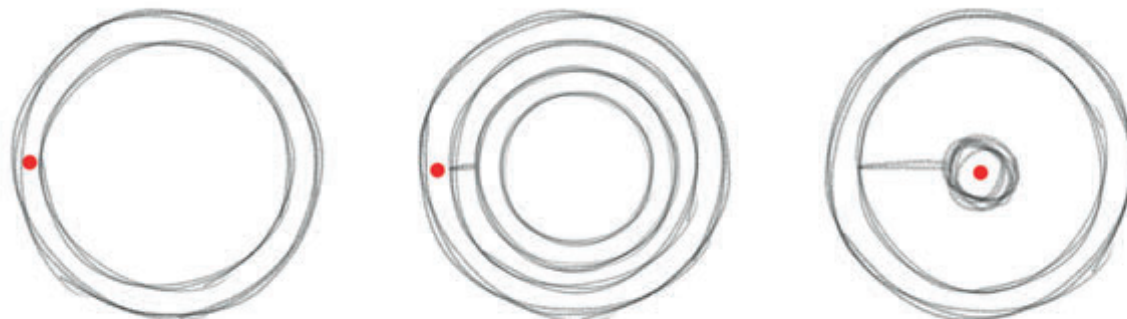

## Do you want to create a composition of circles? We have what you are looking for!

Thanks to the bases designed to pass the power cable from one lamp to the next, you can create sequences and illuminate large spaces. You can even put a Polo inside another Polo!

Example 01

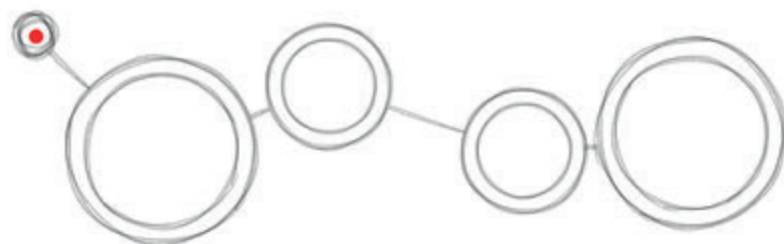

Example 02

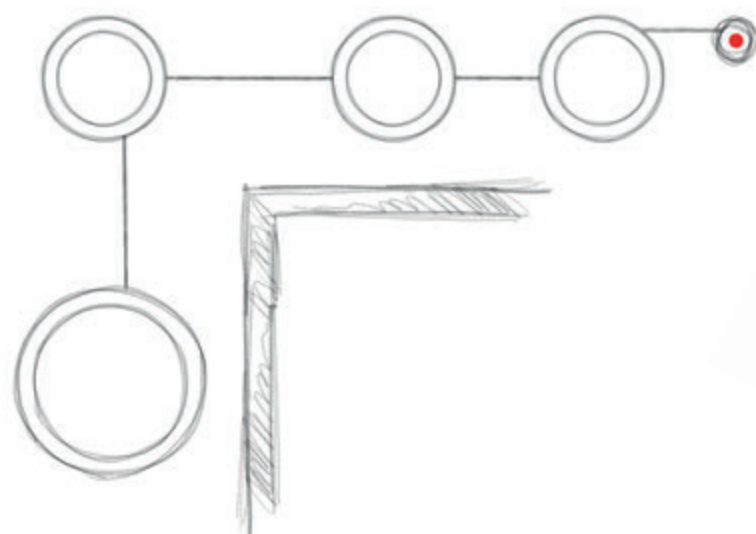

Example 03

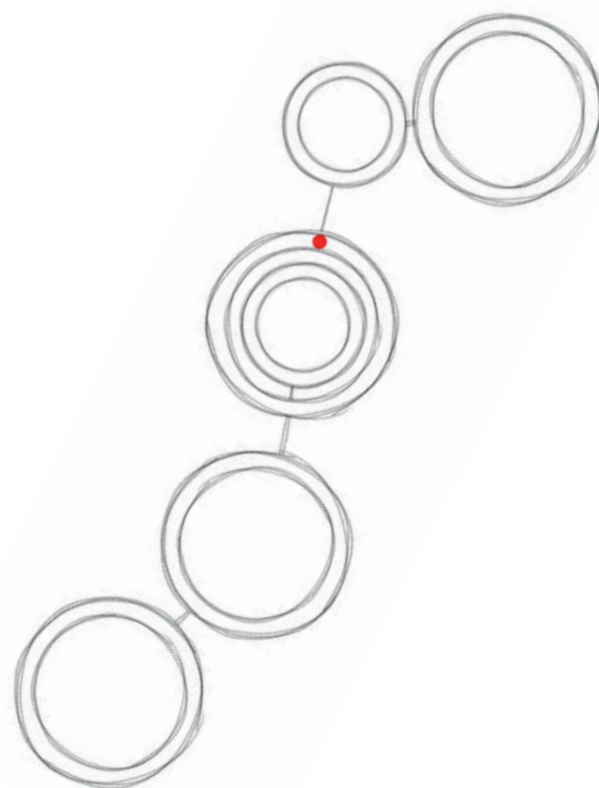

**Polo\_S** | 220-240 V | topLED 27 W DC - 31 W AC



Product	Cct	Cri	lm S	lm D	Optics
9160	3000	80	3568	3222	Diffused

**Accessory Description**

<b>KIT0107</b>	Decentralization kit ON/OFF canopy (Ø 80 mm)
----------------	--

**Polo\_S** | 220-240 V | topLED 45 W DC - 51 W AC

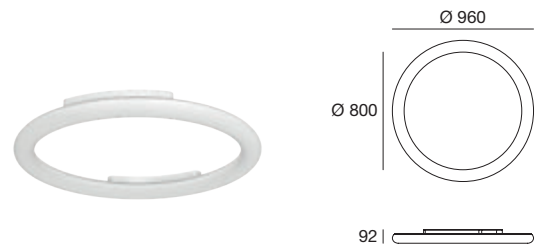

Product	Cct	Cri	lm S	lm D	Optics
9161	3000	80	5966	5118	Diffused

**Accessory Description**

<b>KIT0107</b>	Decentralization kit ON/OFF canopy (Ø 80 mm)
<b>KIT0108</b>	Decentralization kit DALI canopy (Ø 160 mm)





# Sinfonia System

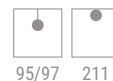

95/97 211

Corpo in alluminio verniciato bianco o nero raggrinzante, oppure nelle finiture galvaniche cromo e oro spazzolato. Diffusore in polimetilmetacrilato.

Body in wrinkle effect white or black painted aluminium, or in the galvanic chrome and brushed gold finishes. Diffuser in polymethylmethacrylate.





### Composizione radiale.

Nella composizione radiale, ad ogni uscita puoi associare una lampada.

### Radial composition.

In the radial composition, you can associate a lamp with each output.

### Composizione lineare.

Nella composizione lineare, puoi creare linee di lampade disposte in serie (vedi pag. 285 "Quante lampade posso collegare per ogni uscita?").

### Linear composition.

In the linear composition, create lines of lamps arranged in series (see p. 285 - "How many lamps can I connect per output?").

## Uno spartito di luce.

Il sistema Sinfonia include lampade di forme, dimensioni e finiture diverse che si combinano come note di uno spartito. Puoi realizzare composizioni radiali, lineari oppure miste, creando la tua personale sinfonia di luce.

## A score of light.

The Sinfonia system includes lamps of different shapes, sizes and finishes that can be composed like notes in a score. You can create radial, linear or mixed compositions to conduct your own personal symphony of light.



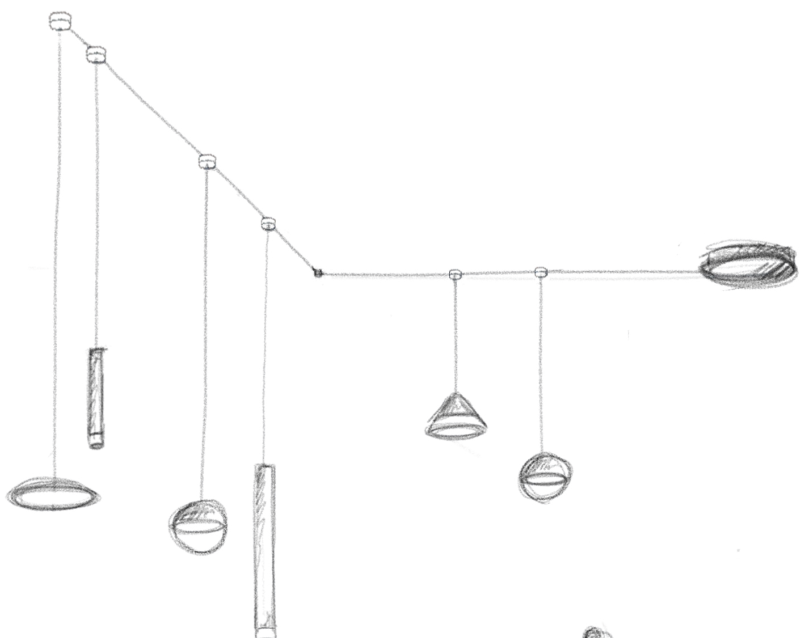

## Sperimenta combinazioni di lampade diverse.

Puoi mixare le lampade per creare combinazioni di forme e luci a piacere. Puoi addirittura mixare le composizioni.

## Experiment with different lamp combinations.

Mix and match the lamps to create combinations of form and light as desired. You can even mix compositions.

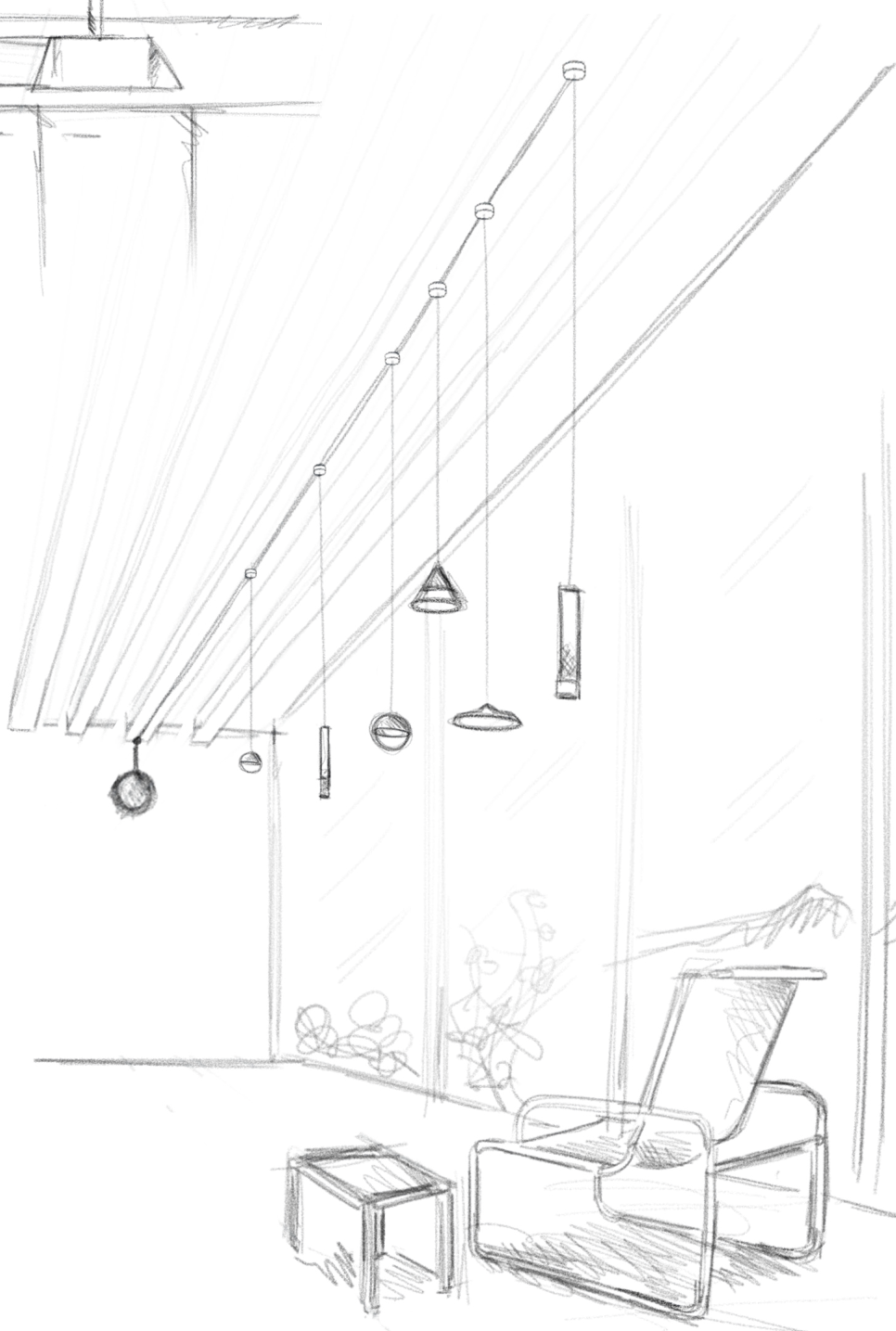
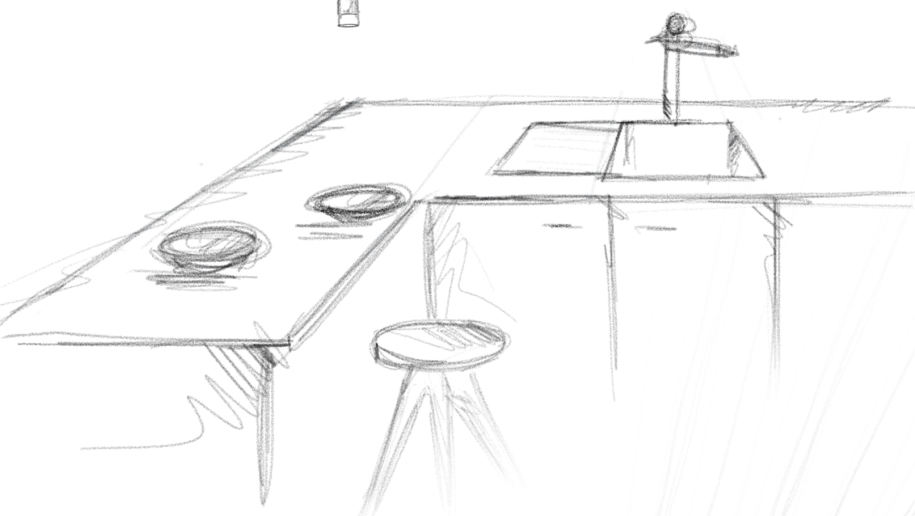

## E se il punto luce è a parete? E se ho un soffitto travato?

Nessun problema! Grazie ai nottolini passacavo e al cavo di connessione acquistabili a parte, nulla è precluso.

## What if the light point is on the wall? What if I have a beamed ceiling?

No problem! Thanks to the separately-purchasable cable grommets and connection cable, nothing is impossible!

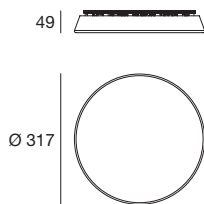

Accessory	Description
	<b>KIT0090</b> Master canopy
	<b>KIT0091</b>
	<b>KIT0092</b>
	<b>KIT0094</b>



Accessory	Description
	<b>KIT0106</b> Connection cable

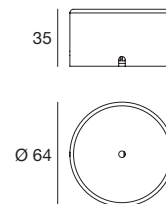

Accessory	Description
	<b>KIT0100</b> Wire cover kit
	<b>KIT0101</b>
	<b>KIT0102</b>
	<b>KIT0104</b>



Accessory	Description
	<b>KIT0110</b> Decentralizing fairlead

## Quante lampade posso collegare per ogni uscita?

Immagina di dividere il rosone master a metà in due semicerchi, A e B. Puoi associare fino ad un massimo di 6 lampade in tutto per ogni semicerchio (quindi 6x2=12 lampade in totale).  
Puoi decidere liberamente come disporle, l'importante è non collegarne più di 6 per semicerchio: puoi disporle tutte e 6 in fila, creando una composizione lineare; oppure creare due file rispettivamente da 4 e da 2 lampade; oppure, puoi disporne una per ogni uscita, creando una composizione radiale.

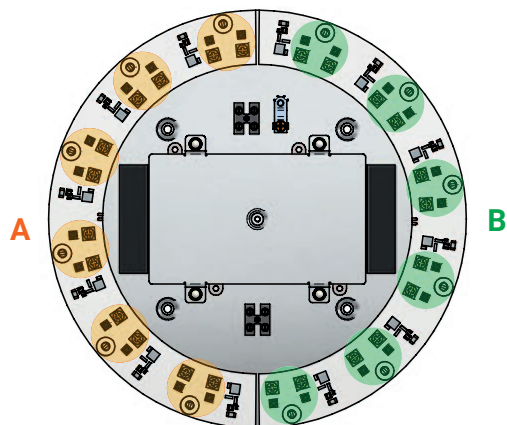

**Section A**  
6 uscite disponibili / MAX 6 art. in totale per l'intera sezione A  
6 output slots / MAX 6 art. TOT for section A

**Section B**  
6 uscite disponibili / MAX 6 art. in totale per l'intera sezione B  
6 output slots / MAX 6 art. TOT for section B

MAX 12 art. per rosone MASTER (**A+B**)  
MAX 12 art. for MASTER canopy (**A+B**)

**A+B** Unica accensione dimmerabile  
**A+B** Single dimmer light switch

## How many lamps can I connect per output?

Imagine dividing the master rosette in half into two semicircles, A and B. You can associate up to a maximum of 6 lamps in total per semicircle (so 6 x 2 = 12 lamps in total). You are even free to decide how to arrange them, with the important thing being not to connect more than 6 per semicircle. Arrange all 6 in a row to create a linear composition, form two rows of 4 and 2 lamps respectively or even arrange one per outlet to create a radial composition.



Sinfonia system / Puccini | topLED 1,7 W DC 350 mA

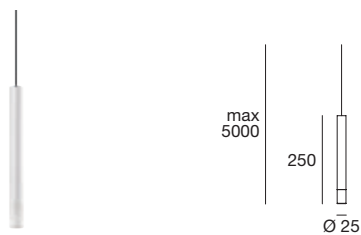

Product	Cct	Cri	Im S	Im D	Optics
9505	3000	90	230	148	Diffused
9506					
9507					
9509					



Included

Sinfonia system / Puccini | topLED 1,7 W DC 350 mA

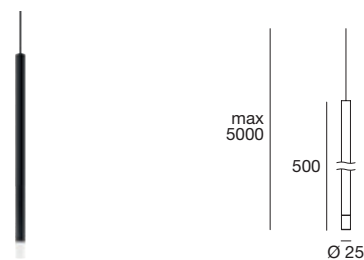

Product	Cct	Cri	Im S	Im D	Optics
9510	3000	90	230	148	Diffused
9511					
9512					
9514					



Included

Sinfonia system / Puccini | topLED 5,1 W DC 350 mA



Product	Cct	Cri	Im S	Im D	Optics
9515	3000	90	450	331	Diffused
9516					
9517					
9519					



Included

Sinfonia system / Puccini | topLED 5,1 W DC 350 mA

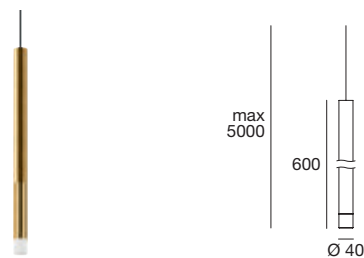

Product	Cct	Cri	Im S	Im D	Optics
9520	3000	90	450	331	Diffused
9521					
9522					
9524					



Included

Finishes

White Black Chrome Brushed Gold

Systems

Sinfonia system / Rossini\_S | topLED 5 W DC 350 mA

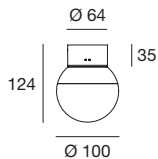

Product	Cct	Cri	Im S	Im D	Optics
9215	3000	90	627	468	Diffused
9216					
9217					
9219					

Sinfonia system / Rossini\_P | topLED 5 W DC 350 mA

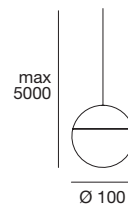

Product	Cct	Cri	Im S	Im D	Optics
9490	3000	90	627	468	Diffused
9491					
9492					
9494					



Included

Sinfonia system / Verdi | topLED 5 W DC 350 mA

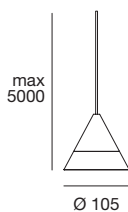

Product	Cct	Cri	Im S	Im D	Optics
9495	3000	90	627	393	Diffused
9496					
9497					
9499					



Included

Sinfonia system / Vivaldi | topLED 5 W DC 350 mA

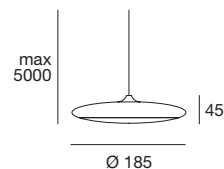

Product	Cct	Cri	Im S	Im D	Optics
9500	3000	90	523	299	Diffused
9501					
9502					
9504					



Included













# CABLES

# Andromeda



Corpo in alluminio verniciato bianco, nero o grigio raggrinzante

White, black or grey painted aluminium lamp body. Wrinkle-effect.

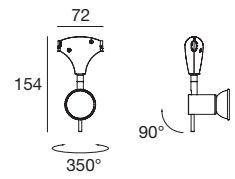

## Andromeda-C\_1 | 220-240 V | GU10



Product	Source
 TR4304-4R	GU10
 TR4304-5	1 x 50 W Max Halogen (LED bulbs compatible)
 TR4304-6	

Accessori / Accessories p. 316/317

# Beebo

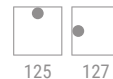

Teste e corpo in alluminio verniciato bianco o grigio raggrinzante. Diffusori in policarbonato trasparente.

Heads and body in white or wrinkle effect grey painted aluminium. Diffusers in clear polycarbonate.

**Beebo-C30** | 220-240 V | arrayLED 17 W DC - 22 W AC

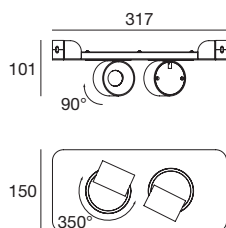

Product	Cct	Cri	lm S	lm D	Optics
□ 8442	3000	90	2164	1598	Diffused
■ 8443					

Accessori / Accessories p. 318/319



## Finishes

□ White ■ Grey

## Cables

295

# Circular



144

Corpo in metallo verniciato bianco o grigio raggrinzante.  
Diffusore in polimetilmetacrilato sabbato.

Body in white or wrinkle effect grey painted metal.  
Sandblasted polymethylmethacrylate diffuser.





**Circular-C** | 220-240 V | topLED 15 W DC - 17 W AC

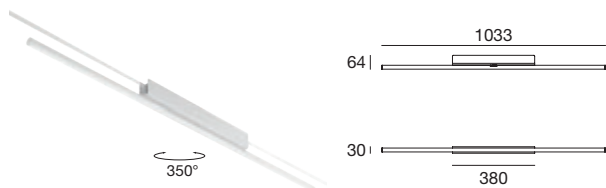

Product	Cct	Cri	Im S	Im D	Optics
8445	3000	90	2094	1515	Diffused
8446					
8447					

Accessori / Accessories p. 316/317

### Rotazione libera a tesata.

Puoi ruotare Circular di ben 350° e creare scenografiche disposizioni asimmetriche.

### Free stretched rotation.

Rotate Circular by as much as 350° to create dramatic asymmetrical arrangements.

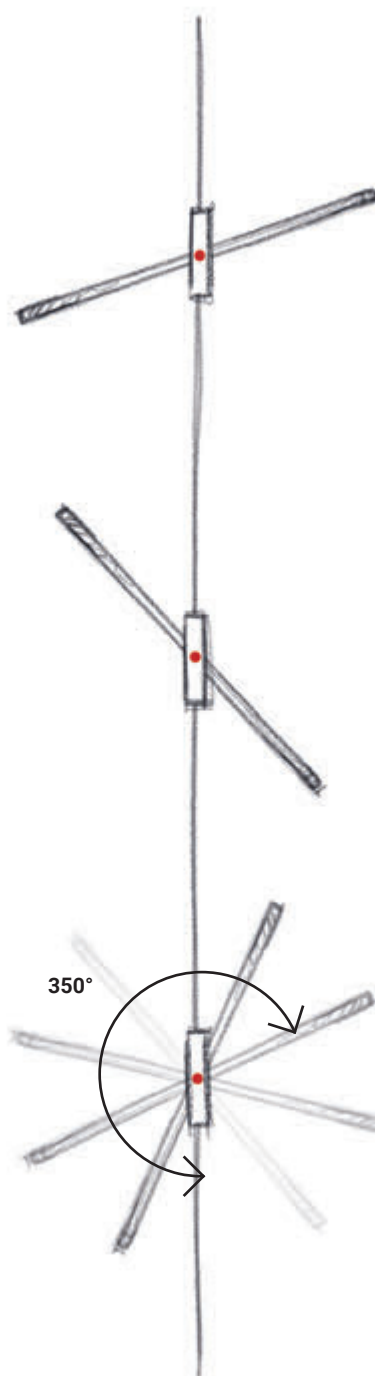

#### Finishes

White Grey Black

# Eta



162

Corpo in alluminio verniciato  
bianco o nero raggrinzante.

Body in white or black wrinkle  
effect painted aluminium.



**Eta-C** | 198-264 V | arrayLED 13 W DC - 15 W AC

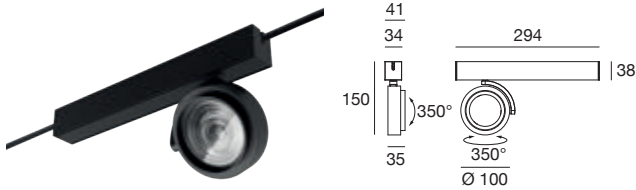

Product	Cct	Cri	lm S	lm D	Optics
□ 9867	3000	90	1440	1154	Spot
■ 9870					
□ 9868	3000	90	1440	1154	M.Flood
■ 9871					
□ 9869	3000	90	1440	1154	W.Flood
■ 9872					

Accessori / Accessories p. 316/317

**Eta-C30** | 198-264 V | arrayLED 25 W DC - 27 W AC

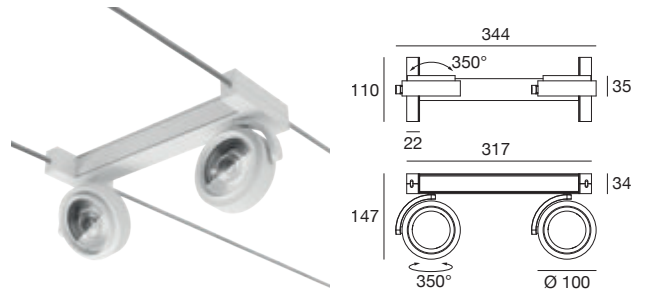

Product	Cct	Cri	lm S	lm D	Optics
□ 9916	3000	90	2880	2308	Spot
■ 9919					
□ 9917	3000	90	2880	2308	M.Flood
■ 9920					
□ 9918	3000	90	2880	2308	W.Flood
■ 9921					

Accessori / Accessories p. 318/319

**Finishes**

□ White ■ Black

**Cables**

# Iota

Corpo in alluminio verniciato bianco o nero  
raggrinzante. Diffusore in policarbonato opalino.

Body in white or black wrinkle effect painted  
aluminium. Opal polycarbonate diffuser.



**lota-C** | 198-264 V | topLED 11 W DC - 13 W AC



Product	Cct	Cri	Im S	Im D	Optics
White 9855	3000	90	1055	676	Diffused
Black 9856					

Accessori / Accessories p. 316/317

**lota-C** | 198-264 V | topLED 22 W DC - 24 W AC



Product	Cct	Cri	Im S	Im D	Optics
White 9857	3000	90	2110	1351	Diffused
Black 9858					

Accessori / Accessories p. 316/317

**lota-C** | 198-264 V | topLED 33 W DC - 36 W AC



Product	Cct	Cri	Im S	Im D	Optics
White 9859	3000	90	3165	2026	Diffused
Black 9860					

Accessori / Accessories p. 316/317

**Finishes**

White Black



**lota-C30\_1** | 198-264 V | topLED 54 W DC - 58 W AC

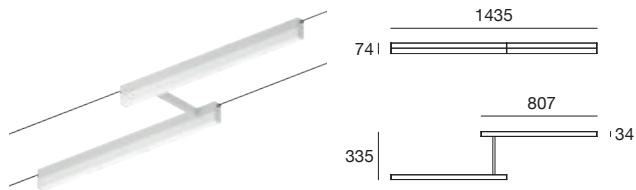

Product	Cct	Cri	Im S	Im D	Optics
□ 9861	3000	90	5652	3265	Diffused
■ 9862					

Accessori / Accessories p. 318/319

**lota-C30\_2** | 198-264 V | topLED 20 W DC - 22 W AC

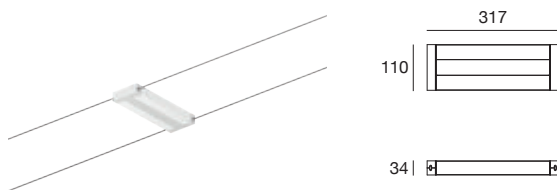

Product	Cct	Cri	Im S	Im D	Optics
□ 9863	3000	90	1992	1423	Diffused
■ 9864					

Accessori / Accessories p. 318/319

**lota-C30\_3** | 198-264 V | topLED 54 W DC - 58 W AC

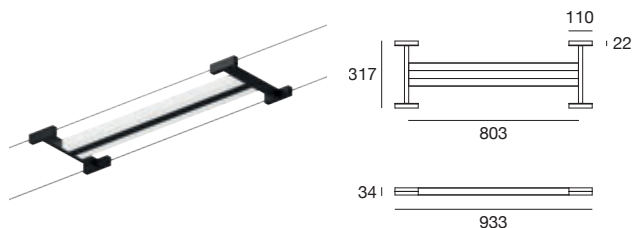

Product	Cct	Cri	Im S	Im D	Optics
□ 9865	3000	90	5652	3885	Diffused
■ 9866					

Accessori / Accessories p. 318/319

**Finishes**

□ White   ■ Black

# Matrix



Teste e corpo in alluminio verniciato bianco o grigio raggrinzante. Diffusori in policarbonato trasparente.

Body in white or wrinkle effect grey painted aluminium. Diffuser in clear polymethylmethacrylate.

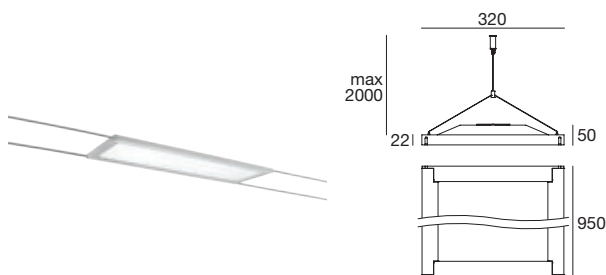

**Matrix-C30** | 220-240 V | topLED 47 W DC - 50 W AC



	Product	Cct	Cri	lm S	lm D	Optics
	54284N00	4000	85	7665	4470	Diffused
	54285N00					

Accessori / Accessories p. 318/319



# Outlook

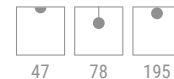

Corpo in alluminio verniciato bianco  
raggrinzante. Diffusore in vetro trasparente.

Body in wrinkle effect white painted  
aluminium. Diffuser in clear glass.

**Outlook-C** | 220-240 V | arrayLED 8 W DC - 11 W AC

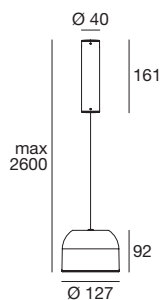

Product	Cct	Cri	lm S	lm D	Optics
8422	3000	90	1082	820	W.Flood (62°)



Included

Accessori / Accessories p. 316/317



## Finishes

White

## Cables

305

# Oh!-C

Diffusore in polietilene. Montatura in metallo verniciato bianco raggrinzante.



Polyethylene diffuser. Mount in white painted metal with wrinkle effect.



**Oh!-C1** | 220-240 V | topLED 6 W DC - 6 W AC



Product	Cct	Cri	lm S	lm D	Optics
□ 10115	3000	80	836	625	Diffused
■ 10116					

Accessori / Accessories p. 316/317

**Oh!-C2\_280** | 220-240 V | topLED 7 W DC - 8 W AC

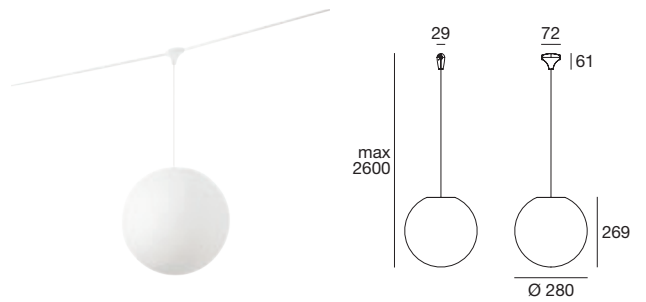

Product	Cct	Cri	lm S	lm D	Optics
□ 12140	3000	80	1022	845	Diffused



Included

Accessori / Accessories p. 316/317

**Oh!-C30\_280** | 220-240 V | topLED 7 W DC - 8 W AC

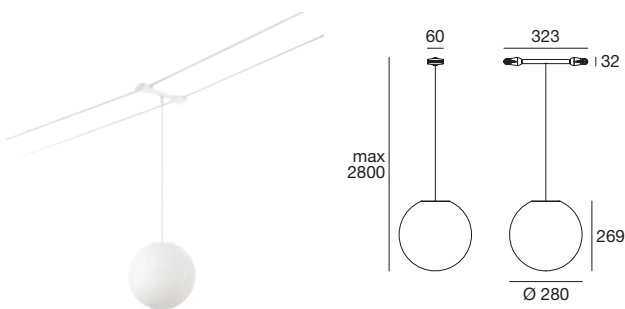

Product	Cct	Cri	lm S	lm D	Optics
□ 12142	3000	80	1022	845	Diffused



Included

Accessori / Accessories p. 318/319

**Oh!-C30\_380** | 220-240 V | topLED 13 W DC - 15 W AC

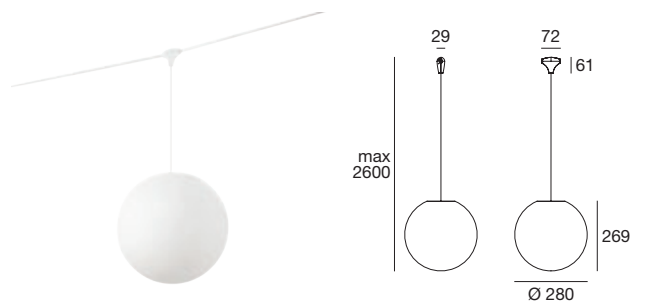

Product	Cct	Cri	lm S	lm D	Optics
□ 12145	3000	80	1922	1584	Diffused



Included

Accessori / Accessories p. 316/317

**Finishes**

□ White ■ Grey

**Cables**

# Polo

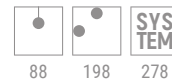

Diffusore in polietilene.  
Montatura in policarbonato bianco.

Polyethylene diffuser.  
White polycarbonate mount.



**Polo-C\_660** | 220-240 V | topLED 27 W DC - 31 W AC



Product	Cct	Cri	lm S	lm D	Optics
□ <b>9166</b>	3000	80	3568	3222	Diffused

Accessori / Accessories p. 316/319

**Polo-C\_960** | 220-240 V | topLED 45 W DC - 51 W AC

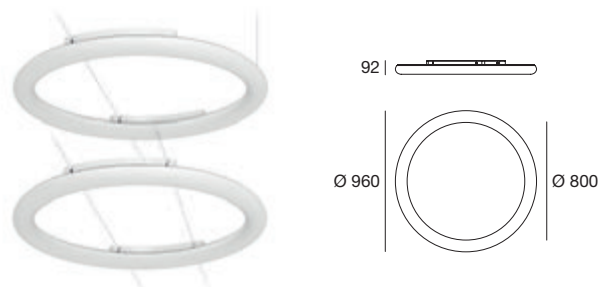

Product	Cct	Cri	lm S	lm D	Optics
□ <b>9167</b>	3000	80	5966	5118	Diffused

Accessori / Accessories p. 316/319

# Trix

Corpo in alluminio verniciato bianco o nero  
raggrinzante. Diffusore in polimetilmetacrilato con  
microincisioni al laser (OptiLight Technology™).

Body in white or black wrinkle effect painted  
aluminium. Polymethylmethacrylate diffuser with  
laser micro-engraving (OptiLight Technology™).



**Trix-C** | 220-240 V | topLED 18 W DC - 19 W AC

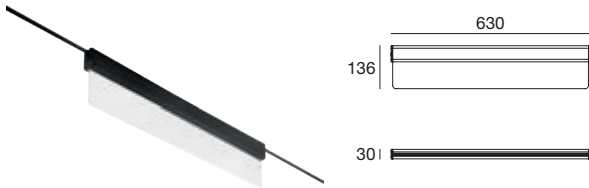

Product	Cct	Cri	lm S	lm D	Optics
8429	3000	80	2370	1815	Diffused
8430					
8431					

Accessori / Accessories p. 316/317

**Trix-C30\_1** | 220-240 V | topLED 18 W DC - 21 W AC



Product	Cct	Cri	lm S	lm D	Optics
8425	3000	80	2370	1608	Diffused
8426					
8432					

Accessori / Accessories p. 318/319

**Trix-C30\_2** | 220-240 V | topLED 36 W DC - 42 W AC

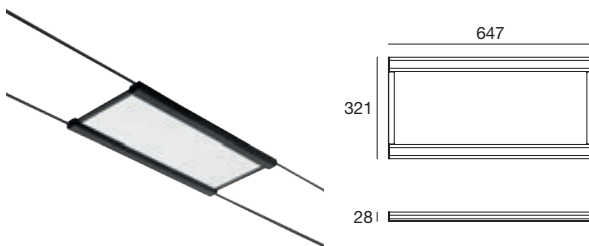

Product	Cct	Cri	lm S	lm D	Optics
8427	3000	80	4740	3560	Diffused
8428					
8433					

Accessori / Accessories p. 318/319

**Finishes**



**Cables**

# TU-V



106

Diffusore in polimetilmetacrilato opalino. Tappi di chiusura in alluminio verniciato bianco raggrinzante.

Diffuser in opal polymethylmethacrylate. Closing caps in wrinkle effect white painted aluminium.





**TU-V-C** | 220-240 V | topLED 16 W DC - 20 W AC

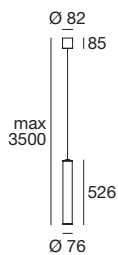

Product	Cct	Cri	lm S	lm D	Optics
<input type="checkbox"/> 8650	3000	80	2414	2069	Diffused



Included

Accessori / Accessories p. 316/317

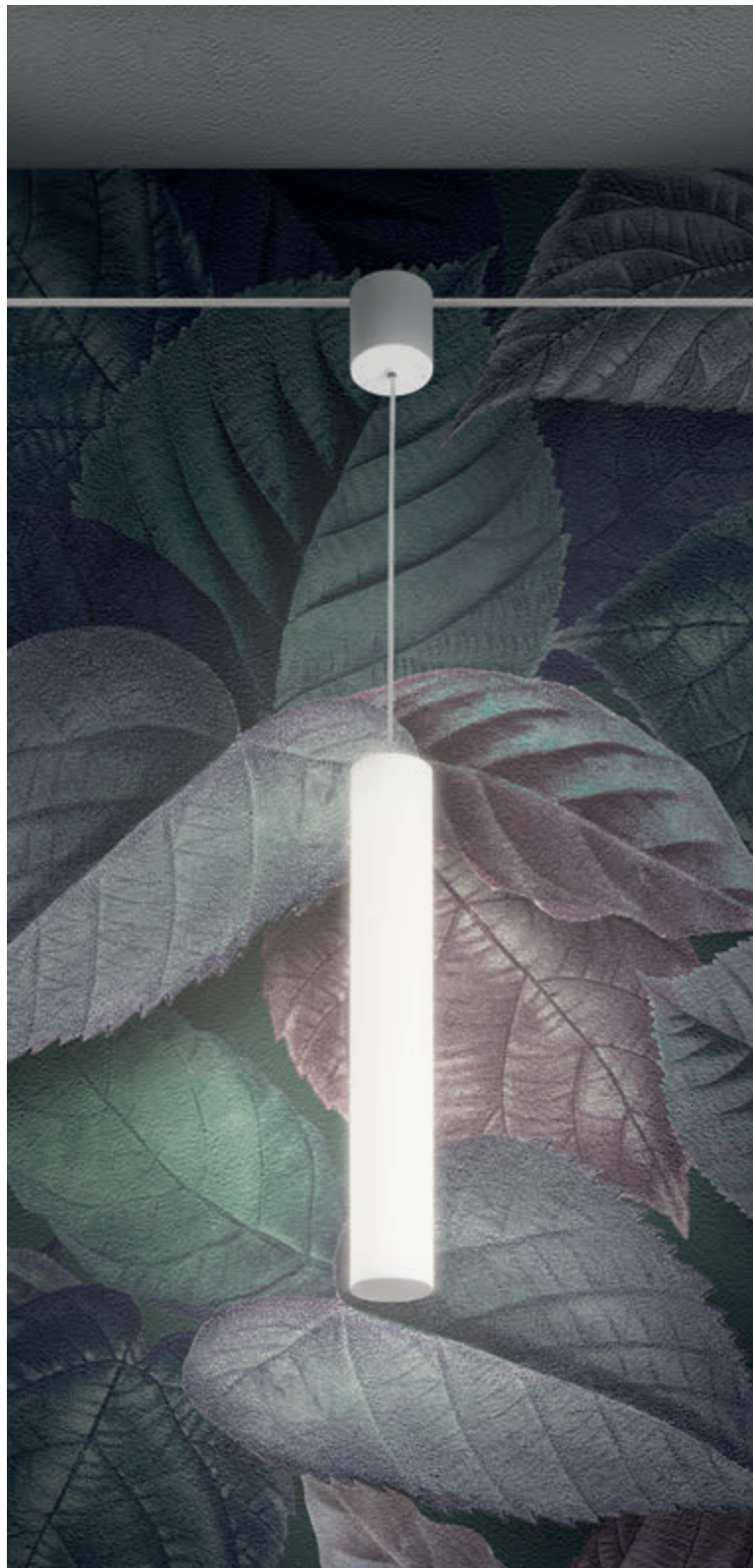

**Finishes**

White

**Cables**

# Vega



**Vega-C30\_1** | 220-240 V | R7s



Product	Source
□ TR4000-4	R7s
■ TR4000-5	1 x 200 W Max Halogen 114 mm (LED bulbs compatible)

Corpo in policarbonato nelle finiture bianco o grigio metallizzato. Diffusore in vetro sabbato.

Polycarbonate body in white or metallic grey finishes. Sandblasted glass diffuser.

**Accessori / Accessories p. 318/319**

**Vega-C30\_2** | 220-240 V | PAR30

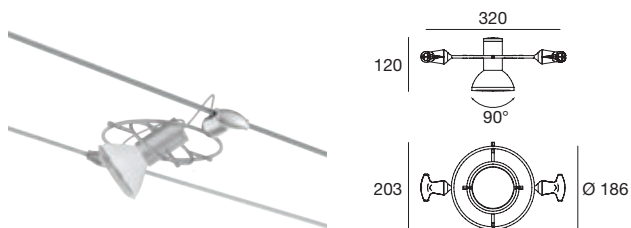

Product	Source
□ TR4014-4	PAR30
■ TR4014-5	1 x 77 W Max Halogen (LED bulbs compatible)

Corpo in metallo nelle finiture bianco o grigio metallizzato.

Metal body in white or metallic grey finishes.

**Accessori / Accessories p. 318/319**

**Kit di fissaggio a muro / Fastening kit wall**

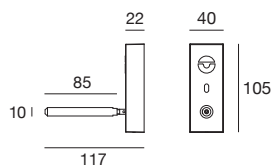

**Product**

- 9853
- 9854

NEW

**Kit di fissaggio a muro e soffitto / Fastening kit wall and ceiling**

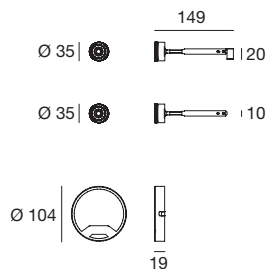

**Product**

- TR4111-4
- TR4111-5
- TR4111-6

NEW

**Kit di alimentazione / Power supply kit**

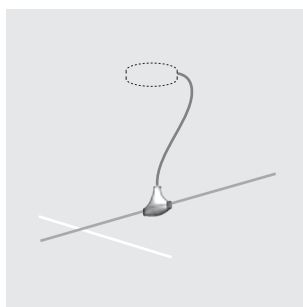
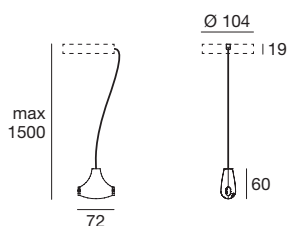

**Product**

- 8704
- 8705
- 8706

NEW

**Kit di alimentazione / Power supply kit**

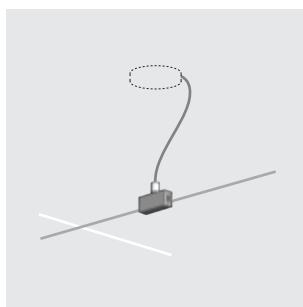
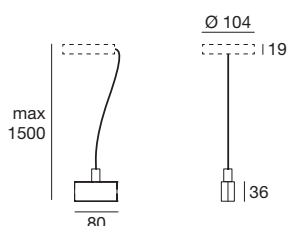

**Product**

- 8711
- 8712
- 8713

NEW

**Distanziatore / Spacer**

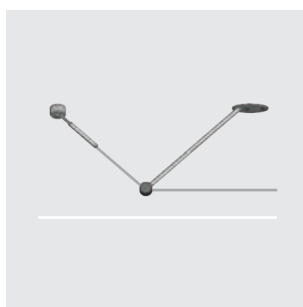
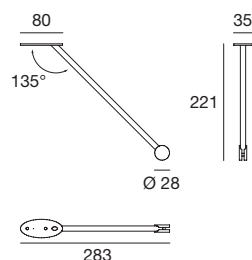

**Product**

- TR4114-4
- TR4114-5
- TR4114-6

NEW

## Kit deviatore a parete / Wall switch kit



### Product

■ ■ ■ TR4120-3

## Kit deviatore a soffitto / Ceiling switch kit



### Product

□ TR4117-4R  
■ TR4117-5  
■ TR4117-6

NEW

## Kit sostegno / Support kit

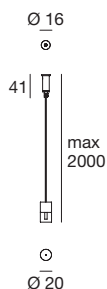

### Product

□ TR4119-4  
■ TR4119-5  
■ TR4119-6

NEW

## Cavi / Cables



### Cavo trasparente

Cavo di supporto e due conduttori, sezione 2x1,5 mm<sup>2</sup>

### Transparent cable

Supporting cable and two conductors, section 2x1,5 mm<sup>2</sup>



### Cavo nero

Cavo di supporto e due conduttori, sezione 2x1,5 mm<sup>2</sup>

### Black cable

Supporting cable and two conductors, section 2x1,5 mm<sup>2</sup>

### Transparent L (mm)

TR4151-5 5000  
TR4151-10 10000  
TR4151-20 20000  
TR4151-30 30000  
TR4151-50 50000

### Black L (mm)

TR4153-5 5000  
TR4153-10 10000  
TR4153-20 20000  
TR4153-30 30000  
TR4153-50 50000

NEW

## Finishes

□ White ■ Black ■ ■ Chrome ■ Grey

## Cables

**Kit di fissaggio a muro / Fastening kit wall**

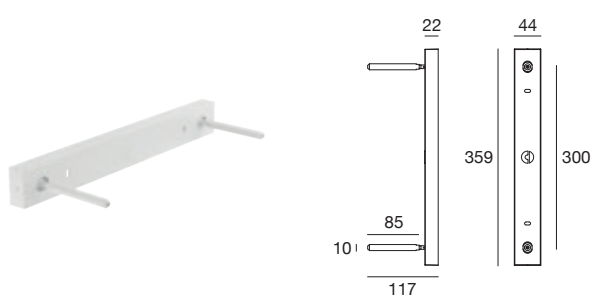

**Product**

- 9873
- 9874

Non installabile con cavi inclinati orizzontalmente.  
Cannot be installed with horizontally inclined cables.

NEW

**Kit di fissaggio a muro e soffitto / Fastening kit wall and ceiling**

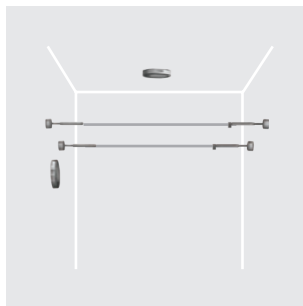
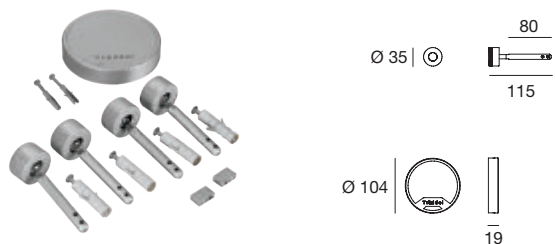

**Product**

- TR4109-4
- TR4109-5
- TR4109-6

NEW

**Kit di alimentazione / Power supply kit**

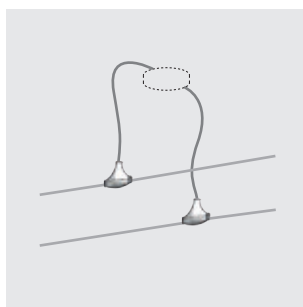
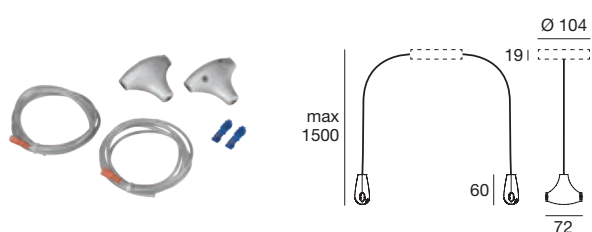

**Product**

- 8729
- 8730
- 8731

NEW

**Kit di alimentazione / Power supply kit**

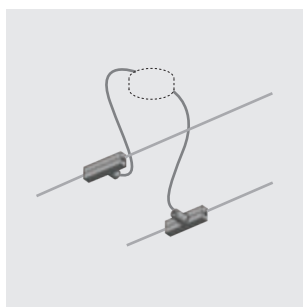
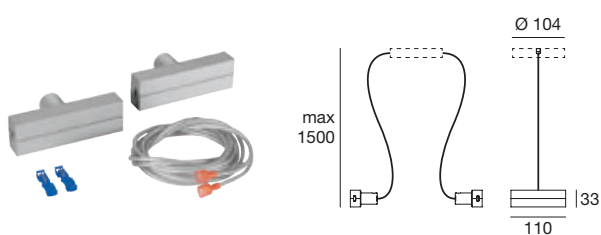

**Product**

- 8720
- 8721
- 8722

NEW

**Distanziatore / Spacer**

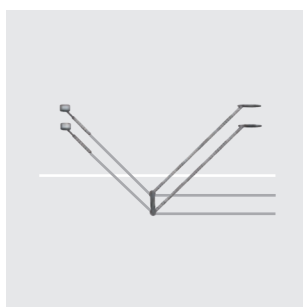
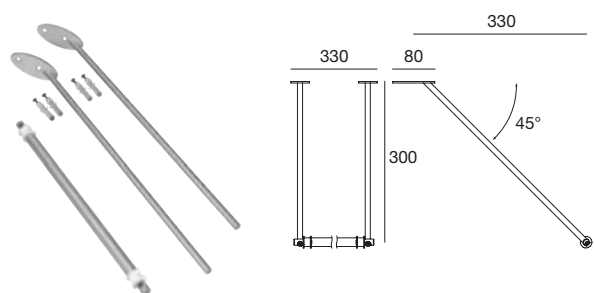

**Product**

- TR4101-4
- TR4101-5
- TR4101-6

NEW

## Kit sostegno / Support kit

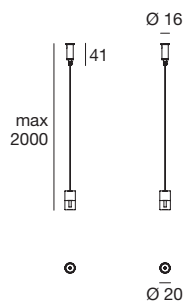

### Product

- TR4103-4
- TR4103-5
- TR4103-6

NEW

## Kit deviatore a soffitto / Ceiling switch kit

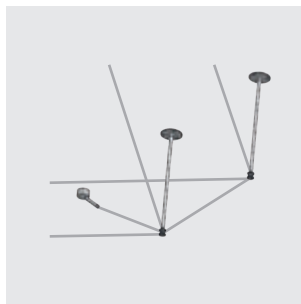
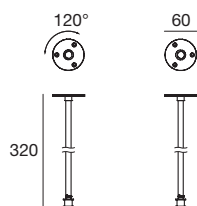

### Product

- TR4105-4R
- TR4105-5
- TR4105-6

NEW

## Kit deviatore a soffitto-muro / Ceiling-wall switch kit

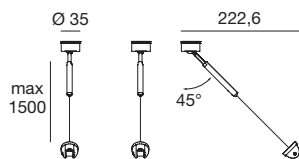

### Product

- TR4124-4
- TR4124-5
- TR4124-6

NEW

## Kit deviatore a parete / Wall switch kit

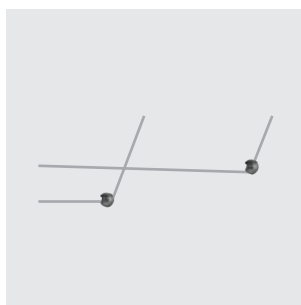

### Product

- TR4104-3

## Cavi / Cables



### Cavo trasparente

Cavo di supporto e due conduttori, sezione 2x1,5 mm<sup>2</sup>

### Transparent cable

Supporting cable and two conductors, section 2x1,5 mm<sup>2</sup>



### Cavo nero

Cavo di supporto e due conduttori, sezione 2x1,5 mm<sup>2</sup>

### Black cable

Supporting cable and two conductors, section 2x1,5 mm<sup>2</sup>

### Transparent L (mm)

- TR4151-5 5000
- TR4151-10 10000
- TR4151-20 20000
- TR4151-30 30000
- TR4151-50 50000

### Black L (mm)

- TR4153-5 5000
- TR4153-10 10000
- TR4153-20 20000
- TR4153-30 30000
- TR4153-50 50000

NEW

## Finishes

- White
- Black
- Chrome
- Grey

## Cables







**OUTDOOR  
PENDANT  
LUMINAIRES**

# Lira

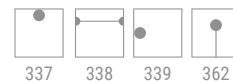

Corpo e rosone in alluminio o in acciaio inox AISI 304 verniciato nero o dark brown raggrinzante. Diffusore in resina poliuretana bianca.

Body and ceiling rose in aluminium or AISI 304 stainless steel painted black or dark brown with wrinkle effect. Diffuser in white polyurethane resin.



**Lira\_PB** | 220-240 V | topLED 27 W DC - 31 W AC

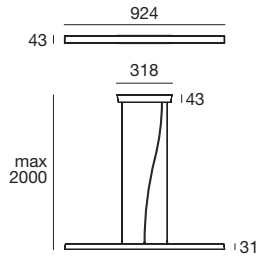

Product	Cct	Cri	lm S	lm D	Optics
9330	3000	80	4136	1352	Diffused
9331					

**Lira\_PR** | 220-240 V | topLED 24 W DC - 29 W AC

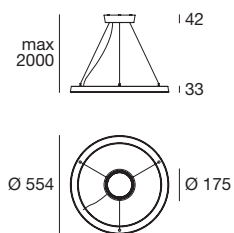

Product	Cct	Cri	lm S	lm D	Optics
9322	3000	80	3924	1402	Diffused
9323					



**Finishes**

Dark Brown Black

# Oh!



Diffusore in polietilene. Rosone in metallo verniciato bianco raggrinzante.

Polyethylene diffuser. Ceiling rose in wrinkle effect white painted metal.



**Oh!\_P65 LED** | 220-240 V | arrayLED 6 W DC 350 mA

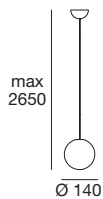

Product	Cct	Cri	Im S	Im D	Optics
15111	3000	80	836	625	Diffused

**Electronics Description**

**KIT0066** | ON / OFF Driver (1-2 art.)

**Oh!\_P65 LED** | 220-240 V | arrayLED 7 W DC 350 mA

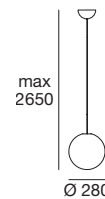

Product	Cct	Cri	Im S	Im D	Optics
16113	3000	80	1022	845	Diffused

**Electronics Description**

**KIT0066** | ON / OFF Driver (1-2 art.)

**Oh!\_P65 LED** | 220-240 V | topLED 13 W DC - 15 W AC

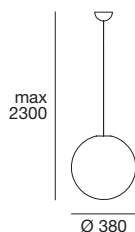

Product	Cct	Cri	Im S	Im D	Optics
16106	3000	80	1930	1584	Diffused

**Oh!\_P65 LED** | 220-240 V | topLED 18 W DC - 20 W AC

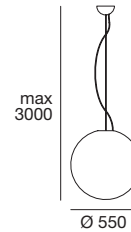

Product	Cct	Cri	Im S	Im D	Optics
16110	3000	80	2748	2115	Diffused

**Oh!\_P65 LED** | 220-240 V | topLED 26 W DC - 27 W AC

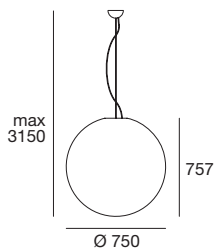

Product	Cct	Cri	Im S	Im D	Optics
16115	3000	80	3835	2856	Diffused

**Finishes**

White

**Outdoor Pendant Luminaires**



Oh!\_P65 E27 | 220-240 V

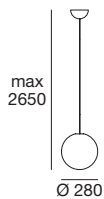
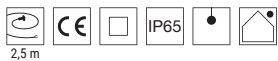

Product	Source
<input type="checkbox"/> 16180	E27 1 x 30 W Max Halogen (LED/FLUORESCENT bulbs compatible)

Oh!\_P65 E27 | 220-240 V

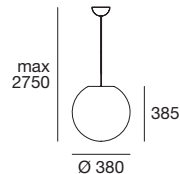

Product	Source
<input type="checkbox"/> 16168	E27 1 x 46 W Max Halogen (LED/FLUORESCENT bulbs compatible)

Oh!\_P65 E27 | 220-240 V

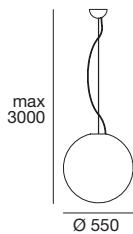

Product	Source
<input type="checkbox"/> 16169	E27 1 x 46 W Max Halogen (LED/FLUORESCENT bulbs compatible)

Oh!\_P65 E27 | 220-240 V

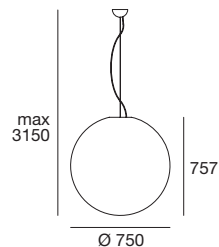

Product	Source
<input type="checkbox"/> 16170	E27 1 x 57 W Max Halogen (LED/FLUORESCENT bulbs compatible)

Finishes

White

# Oh! Smash

Diffusore in polietilene. Rosone in metallo verniciato bianco raggrinzante.

Polyethylene diffuser. Ceiling rose in wrinkle effect white painted metal.





**Oh! Smash\_P65** | 220-240 V | E27

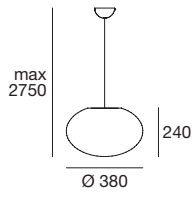

Product	Source
<input type="checkbox"/> 16213	E27 1 x 30 W Max Halogen (LED/FLUORESCENT bulbs compatible)

**Oh! Smash\_P65** | 220-240 V | E27

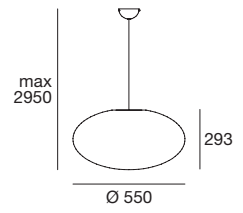

Product	Source
<input type="checkbox"/> 16216	E27 1 x 46 W Max Halogen (LED/FLUORESCENT bulbs compatible)

**Finishes**

White





**OUTDOOR  
CEILING & WALL**

# Alba

Corpo e montatura in alluminio verniciato grigio o dark brown raggrinzante. Diffusore in vetro trasparente.

Body and mount in wrinkle effect grey or dark brown painted aluminium. Diffuser in clear glass.



Alba\_W65 | 220-240 V | arrayLED 16 W DC - 19 W AC

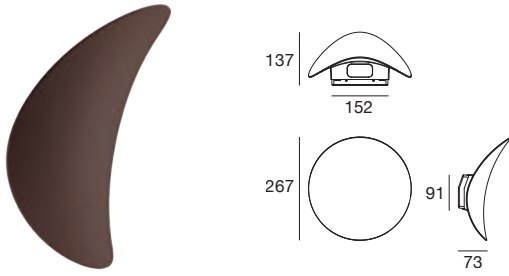

Product	Cct	Cri	lm S	lm D	Optics
9662M	2700	90	1763	1264	Diffused
9663M					
9662	3000	90	1916	1374	Diffused
9663					



Finishes



Outdoor Ceiling & Wall

# Chobin65

Diffusore in silicone. Base in policarbonato.

Silicone diffuser. Polycarbonate base.



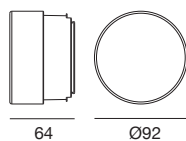

Product	Cct	Cri	Im S	Im D	Optics
8322	3000	80	266	246	Diffused



**Incluso.** Disco metallico per emissioni radiali.  
**Included.** Metal disc for radial emission.

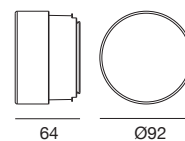

Product	Source
8321	GX53 1 x 4 W Max (LED bulb not included)



**Incluso.** Disco metallico per emissioni radiali.  
**Included.** Metal disc for radial emission.

## Come rimuovere/cambiare il disco How to remove/change the disc



## Esempi di disegni personalizzati

Dischi in metallo personalizzabili su richiesta (lotto 25 pz o multipli - prezzo su richiesta Custom Dept.).

## Examples of custom drawings

Customizable metal discs on request (lot of 25 pcs or multiples - price on request to Custom Dept.).



# Lira

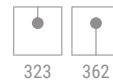

Corpo e montatura in alluminio o in acciaio inox  
AISI 304 verniciato nero o dark brown raggrinzante.  
Diffusore in resina poliuretana bianca.

Body and mount in aluminium or AISI 304 stainless  
steel painted black or dark brown with wrinkle effect.  
Diffuser in white polyurethane resin.





Lira\_SR | 220-240 V | topLED 24 W DC - 29 W AC

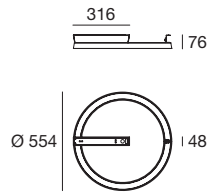

Product	Cct	Cri	Im S	Im D	Optics
9324	3000	80	3924	1402	Diffused
9325					

Lira\_SB | 220-240 V | topLED 19 W DC - 21 W AC

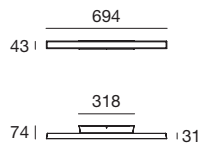
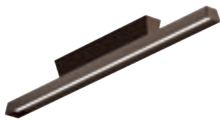

Product	Cct	Cri	Im S	Im D	Optics
9334	3000	80	2952	1001	Diffused
9335					

Lira\_SB | 220-240 V | topLED 27 W DC - 31 W AC

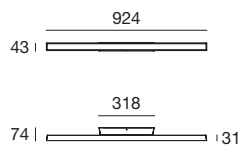
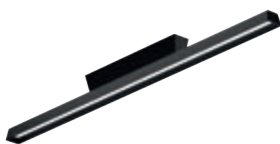

Product	Cct	Cri	Im S	Im D	Optics
9336	3000	80	4136	1352	Diffused
9337					



Finishes

Dark Brown    Black

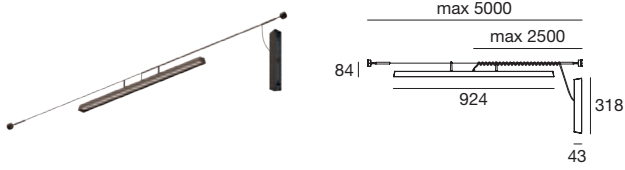

Product	Cct	Cri	Im S	Im D	Optics
9332	3000	80	4136	1352	Diffused
9333					



Lira\_W | 220-240 V | topLED 13 W DC - 16 W AC



Product	Cct	Cri	Im S	Im D	Optics
9338	3000	80	2068	579	Diffused
9339					

Lira\_W | 220-240 V | topLED 19 W DC - 21 W AC



Product	Cct	Cri	Im S	Im D	Optics
9340	3000	80	2952	1001	Diffused
9341					



Finishes

Dark Brown    Black

Outdoor Ceiling & Wall

# MyWhite

Diffusore in polietilene. Montatura in metallo.  
Nelle versioni MiniWhite Cover: copertura in  
policarbonato bianco o nero.

Polyethylene diffuser. Metal mount.  
In the MiniWhite Cover versions:  
white or black polycarbonate cover.



**MyWhite\_R** | 220-240 V | topLED 8 W DC - 10 W AC

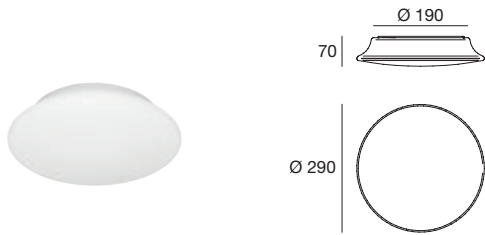

Product	Cct	Cri	lm S	lm D	Optics
<input type="checkbox"/> <b>7805</b>	3000	85	987	680	Diffused
<input type="checkbox"/> <b>7805N</b>	4000	85	1226	776	Diffused

**MyWhite\_R** | 220-240 V | topLED 12 W DC - 16 W AC

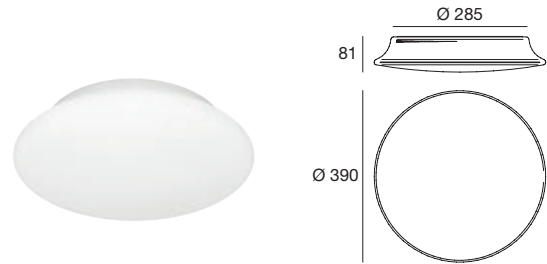

Product	Cct	Cri	lm S	lm D	Optics
<input type="checkbox"/> <b>7806</b>	3000	85	1396	1150	Diffused
<input type="checkbox"/> <b>7806N</b>	4000	85	1533	1313	Diffused

**MyWhite\_R Motion Sensor** | 220-240 V | topLED 12 W DC - 16 W AC

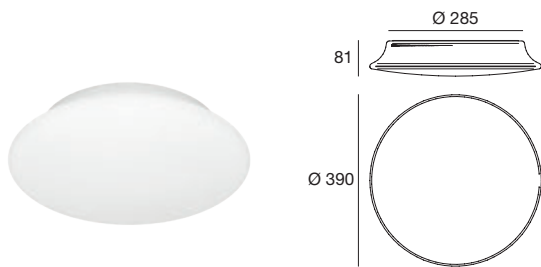
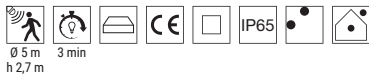

Product	Cct	Cri	lm S	lm D	Optics
<input type="checkbox"/> <b>7806S</b>	3000	85	1396	1150	Diffused
<input type="checkbox"/> <b>7806NS</b>	4000	85	1533	1313	Diffused

**MyWhite\_R Emergency** | 220-240 V | topLED 12 W DC - 16 W AC

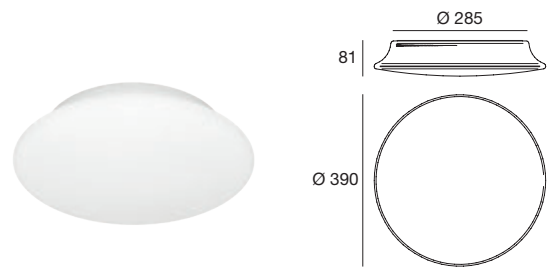

Product	Cct	Cri	lm S	lm D	Optics
<input type="checkbox"/> <b>7806E</b>	3000	85	1396	1150	Diffused
<input type="checkbox"/> <b>7806NE</b>	4000	85	1533	1313	Diffused

**Finishes**

White



**MyWhite\_Q** | 220-240 V | topLED 8 W DC - 10 W AC



Product	Cct	Cri	lm S	lm D	Optics
<input type="checkbox"/> <b>7807</b>	3000	85	987	696	Diffused
<input type="checkbox"/> <b>7807N</b>	4000	85	1226	776	Diffused

**MyWhite\_Q** | 220-240 V | topLED 12 W DC - 16 W AC

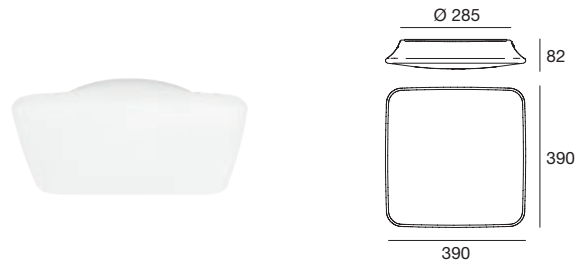

Product	Cct	Cri	lm S	lm D	Optics
<input type="checkbox"/> <b>7808</b>	3000	85	1396	1150	Diffused
<input type="checkbox"/> <b>7808N</b>	4000	85	1533	1313	Diffused

**MyWhite\_Q Motion Sensor** | 220-240 V | topLED 12 W DC - 16 W AC

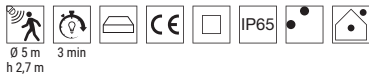

Ø 5 m  
h 2,7 m



Product	Cct	Cri	lm S	lm D	Optics
<input type="checkbox"/> <b>7808S</b>	3000	85	1396	1150	Diffused
<input type="checkbox"/> <b>7808NS</b>	4000	85	1533	1313	Diffused

**MyWhite\_Q Emergency** | 220-240 V | topLED 12 W DC - 16 W AC



3 hours 14%



Product	Cct	Cri	lm S	lm D	Optics
<input type="checkbox"/> <b>7808E</b>	3000	85	1396	1150	Diffused
<input type="checkbox"/> <b>7808NE</b>	4000	85	1533	1313	Diffused

**Finishes**

White





**MyWhite\_B** | 220-240 V | topLED 8 W DC - 11 W AC

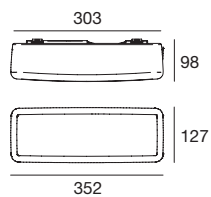

Product	Cct	Cri	lm S	lm D	Optics
<b>7809</b>	3000	85	1002	701	Diffused
<b>7809N</b>	4000	85	1040	800	Diffused

**MyWhite\_B** | 220-240 V | topLED 13 W DC - 17 W AC

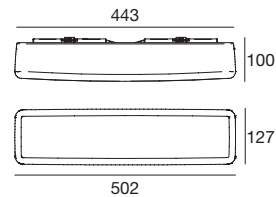

Product	Cct	Cri	lm S	lm D	Optics
<b>7810</b>	3000	85	1586	1009	Diffused
<b>7810N</b>	4000	85	1641	1152	Diffused

**MyWhite\_B Motion Sensor** | 220-240 V | topLED 13 W DC - 17 W AC

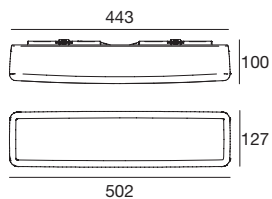
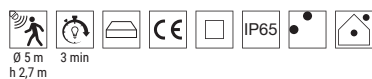

Product	Cct	Cri	lm S	lm D	Optics
<b>7810S</b>	3000	85	1586	1009	Diffused
<b>7810NS</b>	4000	85	1641	1152	Diffused

**MyWhite\_B Emergency** | 220-240 V | topLED 13 W DC - 17 W AC

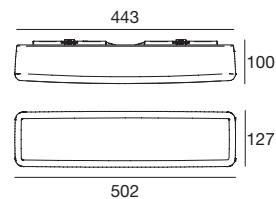

Product	Cct	Cri	lm S	lm D	Optics
<b>7810E</b>	3000	85	1586	1009	Diffused
<b>7810NE</b>	4000	85	1641	1152	Diffused

**Finishes**

White



**MyWhite\_U** | 220-240 V | topLED 9 W DC - 11 W AC

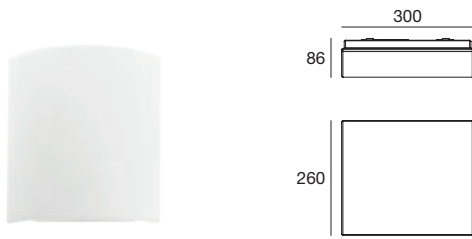

Product	Cct	Cri	Im S	Im D	Optics
<b>7889</b>	3000	85	1175	922	Diffused

**MyWhite\_U** | 220-240 V | topLED 13 W DC - 17 W AC

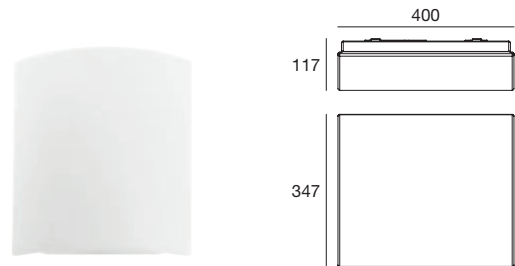

Product	Cct	Cri	Im S	Im D	Optics
<b>7890</b>	3000	85	1522	1756	Diffused

**MiniWhite\_Q** | 220-240 V | topLED 3 W DC - 4 W AC

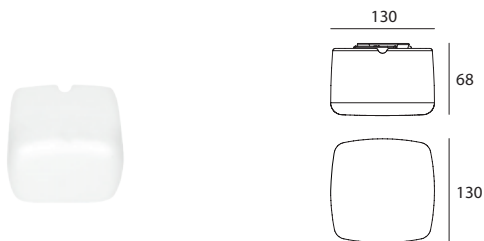

Product	Cct	Cri	Im S	Im D	Optics
<b>8029</b>	3000	85	354	311	Diffused
<b>8029N</b>	4000	85	462	355	Diffused

**MiniWhite\_R** | 220-240 V | topLED 3 W DC - 4 W AC

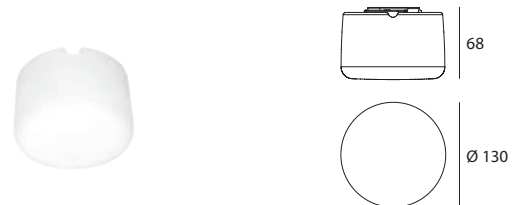

Product	Cct	Cri	Im S	Im D	Optics
<b>8028</b>	3000	85	354	311	Diffused
<b>8028N</b>	4000	85	462	355	Diffused

**Finishes**

White



**MiniWhite Cover\_Q** | 220-240 V | topLED 3 W DC - 4 W AC

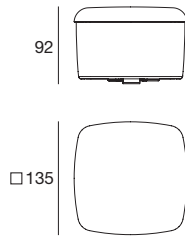

Product	Cct	Cri	Im S	Im D	Optics
□ 8031	3000	85	354	223	Diffused
■ 8033					

**MiniWhite Cover\_Q Double** | 220-240 V | topLED 3 W DC - 4 W AC

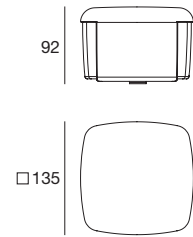

Product	Cct	Cri	Im S	Im D	Optics
□ 8032	3000	85	354	210	Diffused
■ 8034					

**MiniWhite Cover\_R** | 220-240 V | topLED 3 W DC - 4 W AC

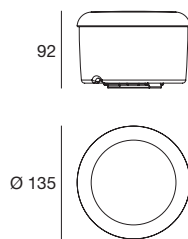

Product	Cct	Cri	Im S	Im D	Optics
□ 8030	3000	85	354	223	Diffused
■ 8026					

**MyWhite Bond\_W** | 220-240 V | topLED 12 W AC

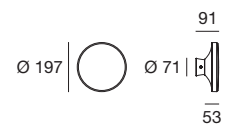

Product	Cct	Cri	Im S	Im D	Optics
■ 8672	3000	80	1350	970	Diffused

**Finishes**

□ White    ■ Black

# Oh!



Diffusore in polietilene.  
Montatura in policarbonato bianco.

Polyethylene diffuser.  
White polycarbonate mount.



**Oh!\_S65 LED** | topLED 7 W DC 350 mA



Product	Cct	Cri	Im S	Im D	Optics
□ 16112	3000	80	1022	845	Diffused

**Electronics Description**

**KIT0066** | ON / OFF Driver (max 1 art.)

**Oh!\_S65 E27** | 220-240 V | E27



Product	Source
□ 16181	E27 1 x 30 W Max Halogen (LED/FLUORESCENT bulbs compatible)

**Oh!\_S65 LED** | 220-240 V | topLED 13 W DC - 15 W AC

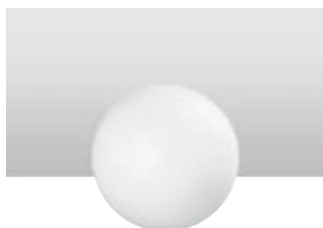

Product	Cct	Cri	Im S	Im D	Optics
□ 16105	3000	80	1930	1584	Diffused

**Oh!\_S65 E27** | 220-240 V | E27

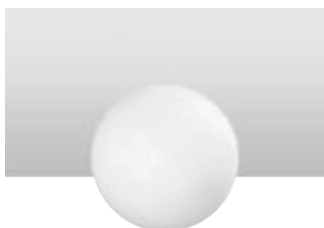

Product	Source
□ 16183	E27 1 x 46 W Max Halogen (LED/FLUORESCENT bulbs compatible)

**Oh!\_S65 LED** | 220-240 V | topLED 18 W DC - 20 W AC

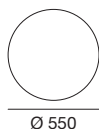
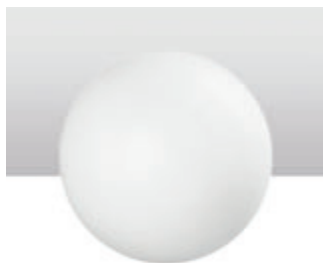

Product	Cct	Cri	Im S	Im D	Optics
□ 16109	3000	80	2748	2115	Diffused

**Oh!\_S65 E27** | 220-240 V | E27

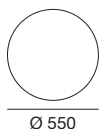
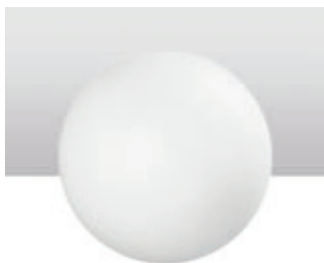

Product	Source
□ 16185	E27 1 x 46 W Max Halogen (LED/FLUORESCENT bulbs compatible)

**Finishes**

□ White

# Oh! Smash

Diffusore in polietilene.  
Montatura in policarbonato bianco.



Polyethylene diffuser.  
White polycarbonate mount.



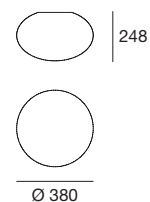

## Oh! Smash\_S65 | 220-240 V | E27

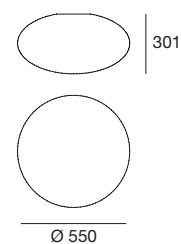

Product	Source
 16214	E27 1 x 30 W Max Halogen (LED/FLUORESCENT bulbs compatible)

## Oh! Smash\_S65 | 220-240 V | E27



Product	Source
 16217	E27 1 x 46 W Max Halogen (LED/FLUORESCENT bulbs compatible)



# Ohps



Diffusore in polietilene.  
Montatura in policarbonato bianco.

Polyethylene diffuser.  
White polycarbonate mount.

**Ohps\_S65 E27** | 220-240 V | E27

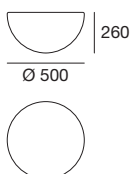

Product	Source
<input type="checkbox"/> 16386	E27 1 x 30 W Max Halogen (LED/FLUORESCENT bulbs compatible)

**Ohps\_S65 E27** | 220-240 V

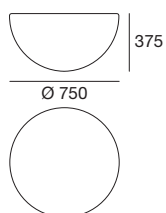

Product	Source
<input type="checkbox"/> 16387	E27 1 x 46 W Max Halogen (LED/FLUORESCENT bulbs compatible)



## Finishes

White

Outdoor Ceiling & Wall

# Switch

Diffusore in polietilene.  
Montatura in policarbonato bianco.

Polyethylene diffuser.  
White polycarbonate mount.

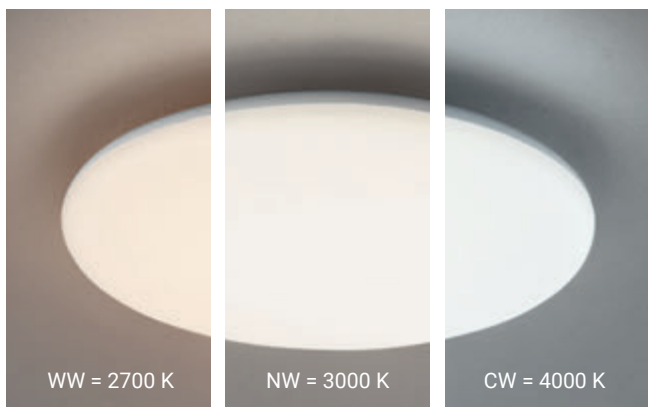

## Switch | 220-240 V | topLED 12 W AC



Product	Cct	Cri	lm S	lm D	Optics
9170	2700	80	1300	1070	Diffused
	3000			1110	
	4000			1151	

## Switch | 220-240 V | topLED 18 W AC



Product	Cct	Cri	lm S	lm D	Optics
9171	2700	80	1800	1616	Diffused
	3000			1665	
	4000			1716	

## Switch | 220-240 V | topLED 25 W AC



Product	Cct	Cri	lm S	lm D	Optics
9172	2700	80	2500	2247	Diffused
	3000			2317	
	4000			2389	

# Vision



Corpo in pressofusione di alluminio.

Die-cast aluminium body.

Vision\_WJ | 220-240 V | GU10

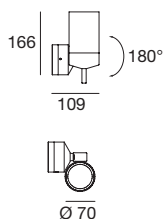

Product	Source
51365	GU10
51366	1 x 50 W Max Halogen (LED bulbs compatible)

Accessory	Description
50370	Pegs



## Finishes

Grey Dark Brown

Outdoor Ceiling & Wall





**OUTDOOR  
FLOOR**

# Bond

Testa palo in policarbonato nero. Diffusore in polietilene. Supporto palo in Bayblend® nero.

Pole head in black polycarbonate. Polyethylene diffuser. Black Bayblend® pole support.



**Bond** | 220-240 V | topLED 12 W AC

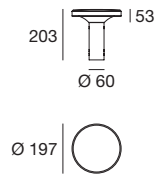

Product	Cct	Cri	lm S	lm D	Optics
<b>8663</b>	3000	80	1350	970	Diffused

KIT IP68 incluso / KIT IP68 included

**Bond** | 220-240 V | topLED 12 W AC

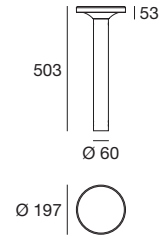

Product	Cct	Cri	lm S	lm D	Optics
<b>8666</b>	3000	80	1350	970	Diffused

KIT IP68 incluso / KIT IP68 included

**Bond** | 220-240 V | topLED 12 W AC

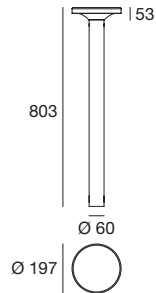

Product	Cct	Cri	lm S	lm D	Optics
<b>8669</b>	3000	80	1350	970	Diffused

KIT IP68 incluso / KIT IP68 included

**Bond\_Head** | 220-240 V | topLED 12 W AC

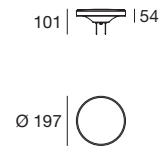

Product	Cct	Cri	lm S	lm D	Optics
<b>8660</b>	3000	80	1350	970	Diffused

**Accessory Description**

**KIT0083** | IP68 kit

**Finishes**

Black

**Outdoor Floor**

# Butler

Corpo in metallo verniciato nero.  
Diffusore in polietilene.

Black painted metal body.  
Polyethylene diffuser.





Butler | 220-240 V | topLED 6 W DC - 8 W AC

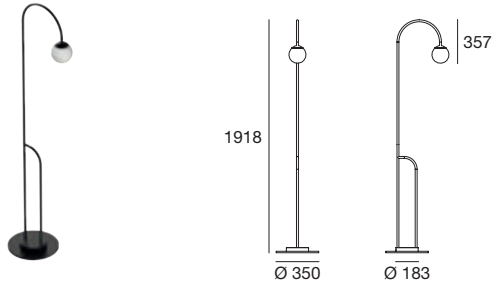

Product	Cct	Cri	lm S	lm D	Optics
9095	3000	90	836	677	Diffused

Accessory	Description
KIT9095	Table and handbag hook



Finishes  
Black

Outdoor Floor

# Lira



Testa, stelo e base in alluminio verniciato nero o dark brown raggrinzante. Diffusore in resina poliuretana bianca.

Head, stem and base in wrinkle effect black or dark brown painted aluminium. Diffuser in white polyurethane resin.





Lira\_FL | 220-240 V | topLED 24 W DC - 29 W AC

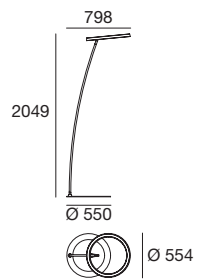

Product	Cct	Cri	lm S	lm D	Optics
9320	3000	80	3924	1402	Diffused
9321					

Finishes

Dark Brown Black

Outdoor Floor

# Marge

Diffusore in polietilene.  
Base in policarbonato bianco.

Polyethylene diffuser.  
White polycarbonate base.



**Marge\_FL65 RGB LED** | stripLED 36 W DC 24 V

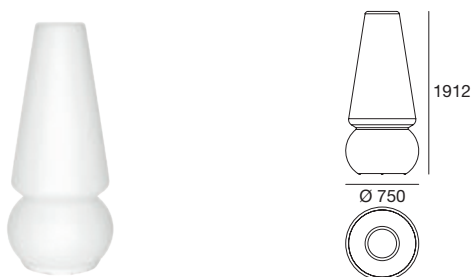

Product	Cct	Cri	Im S	Im D	Optics
16000	RGB				Diffused

**Electronics Description**

14958	KIT Driver RGB + Remote control
-------	---------------------------------

**Accessory Description**

14937	Pegs
10013	Weight
10015	Anti-theft

**Marge\_FL65 E27** | 220-240 V | E27

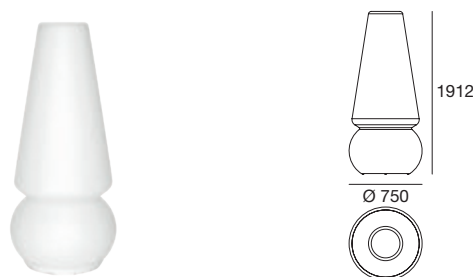

Product	Source
16001	E27 4 x 46 W Max Halogen (LED/FLUORESCENT bulbs compatible)

**Accessory Description**

14937	Pegs
10013	Weight
10015	Anti-theft
14991	IP68 kit



- 15 fixed colors
- white color
- 5 brightness levels
- 16 continuous cycle programs
- 68 colors automatic cycle
- possibility to operate multiple lamps with 1 remote without no sync



**Finishes**

White
-------

**Outdoor Floor**

# Oh!



324 350 262

Diffusore in polietilene.  
Base in policarbonato bianco.

Polyethylene diffuser.  
White polycarbonate base.



**Oh! Dynamic White** | powerLED 3,5 W DC 220 mA



Product	Cct	Cri	lm S	lm D	Optics
16227	1800-5000	80	262-308	218-256	Diffused

**Electronics Description**

<b>C-E700003</b>	Control unit (for max. 2 x 16227)
<b>84647</b>	Driver EXA 75 W
<b>C-W600001</b>	RF Remote

**Accessory Description**

<b>14992</b>	IP68 kit
<b>14930</b>	Outer casing
<b>14931</b>	Pegs

**Oh! Dynamic White** | powerLED 12 W DC 220 mA



Product	Cct	Cri	lm S	lm D	Optics
16228	1800-5000	80	782-937	640-768	Diffused

**Electronics Description**

<b>C-E700003</b>	Control unit (for max. 2 x 16228/16229)
<b>84647</b>	Driver EXA 75 W
<b>C-W600001</b>	RF Remote

**Accessory Description**

<b>14992</b>	IP68 kit
<b>14930</b>	Outer casing
<b>14931</b>	Pegs
<b>14080</b>	Anti-theft

**Oh! Dynamic White** | powerLED 12 W DC 220 mA



Product	Cct	Cri	lm S	lm D	Optics
16229	1800-5000	80	804-959	619-739	Diffused

**Electronics Description**

<b>C-E700003</b>	Control unit (for max. 2 x 16228/16229)
<b>84647</b>	Driver EXA 75 W
<b>C-W600001</b>	RF Remote

**Accessory Description**

<b>14992</b>	IP68 kit
<b>14930</b>	Outer casing
<b>14931</b>	Pegs
<b>14081</b>	Anti-theft

**Oh! Dynamic White** | powerLED 21 W DC 220 mA



Product	Cct	Cri	lm S	lm D	Optics
16230	1800-5000	80	1433-1615	1061-1195	Diffused

**Electronics Description**

<b>C-E700003</b>	Control unit (for max. 2 x 16230)
<b>84647</b>	Driver EXA 75 W
<b>C-W600001</b>	RF Remote

**Accessory Description**

<b>14992</b>	IP68 kit
<b>14930</b>	Outer casing
<b>14937</b>	Pegs
<b>14082</b>	Anti-theft

**Finishes**

White

**Outdoor Floor**





**Oh!\_FL65 LED** | topLED 7 W DC 350 mA



Product	Cct	Cri	lm S	lm D	Optics
16190	3000	80	1022	848	Diffused

**Electronics Description**

**KIT0066** | ON / OFF Driver (1-3 art.)

**Accessory Description**

**14930** | Outer casing  
**14931** | Pegs

**Oh!\_FL65 LED** | 220-240 V | topLED 13 W DC - 15 W AC



Product	Cct	Cri	lm S	lm D	Optics
16191	3000	80	1930	1588	Diffused

**Accessory Description**

**14992** | IP68 kit  
**14930** | Outer casing  
**14931** | Pegs  
**14080** | Anti-theft

**Oh!\_FL65 LED** | 220-240 V | topLED 18 W DC - 20 W AC

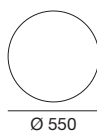

Product	Cct	Cri	lm S	lm D	Optics
16192	3000	80	2748	2115	Diffused

**Accessory Description**

**14992** | IP68 kit  
**14930** | Outer casing  
**14931** | Pegs  
**14081** | Anti-theft

**Oh!\_FL65 LED** | 220-240 V | topLED 26 W DC - 27 W AC

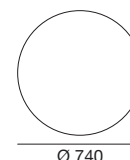

Product	Cct	Cri	lm S	lm D	Optics
16193	3000	80	3835	2856	Diffused

**Accessory Description**

**14992** | IP68 kit  
**14930** | Outer casing  
**14937** | Pegs  
**14082** | Anti-theft

**Finishes**

White



Oh!\_FL65 E27 | 220-240 V | E27

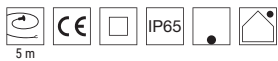

Product	Source
16150	E27 1 x 30 W Max Halogen (LED/FLUORESCENT bulbs compatible)

Accessory	Description
14992	IP68 kit
14930	Outer casing
14931	Pegs

Oh!\_FL65 E27 | 220-240 V | E27



Product	Source
16160	E27 1 x 46 W Max Halogen (LED/FLUORESCENT bulbs compatible)

Accessory	Description
14992	IP68 kit
14930	Outer casing
14931	Pegs
14080	Anti-theft

Oh!\_FL65 E27 | 220-240 V | E27

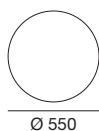

Product	Source
16162	E27 1 x 46 W Max Halogen (LED/FLUORESCENT bulbs compatible)

Accessory	Description
14992	IP68 kit
14930	Outer casing
14931	Pegs
14081	Anti-theft

Oh!\_FL65 E27 | 220-240 V | E27

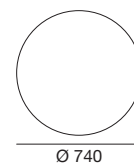

Product	Source
16164	E27 1 x 57 W Max Halogen (LED/FLUORESCENT bulbs compatible)

Accessory	Description
14992	IP68 kit
14930	Outer casing
14937	Pegs
14082	Anti-theft

Finishes

White

# Oh! Mars

Diffusore in polietilene tinta arancio sabbia.  
Base in policarbonato bianco.

Sand orange coloured polyethylene diffuser.  
White polycarbonate base.



Oh!\_Mars E27 | 220-240 V | E27

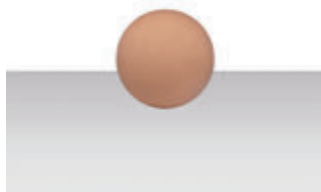

Product	Source
<b>16130</b>	E27 1 x 30 W Max Halogen (LED/FLUORESCENT bulbs compatible)

Accessory	Description
<b>14992</b>	IP68 kit
<b>14930</b>	Outer casing
<b>14931</b>	Pegs

Oh!\_Mars E27 | 220-240 V | E27

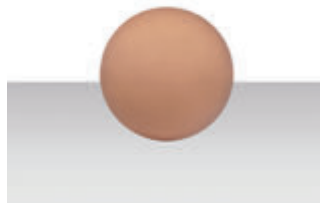

Product	Source
<b>16131</b>	E27 1 x 46 W Max Halogen (LED/FLUORESCENT bulbs compatible)

Accessory	Description
<b>14992</b>	IP68 kit
<b>14930</b>	Outer casing
<b>14931</b>	Pegs
<b>14080</b>	Anti-theft

Oh!\_Mars E27 | 220-240 V | E27

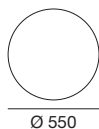
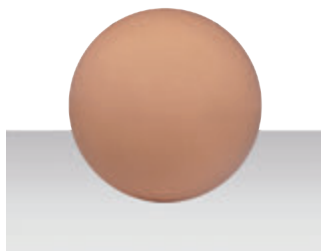

Product	Source
<b>16132</b>	E27 1 x 46 W Max Halogen (LED/FLUORESCENT bulbs compatible)

Accessory	Description
<b>14992</b>	IP68 kit
<b>14930</b>	Outer casing
<b>14931</b>	Pegs
<b>14081</b>	Anti-theft

Oh!\_Mars E27 | 220-240 V | E27

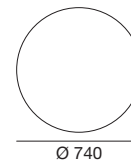

Product	Source
<b>16133</b>	E27 1 x 57 W Max Halogen (LED/FLUORESCENT bulbs compatible)

Accessory	Description
<b>14992</b>	IP68 kit
<b>14930</b>	Outer casing
<b>14937</b>	Pegs
<b>14082</b>	Anti-theft

# Oh! Smash



328

352

264

Diffusore in polietilene.  
Base in policarbonato bianco.

Polyethylene diffuser.  
White polycarbonate base.



**Oh! Smash\_FL65** | 220-240 V | E27

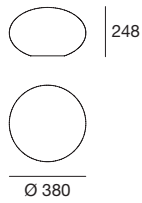

Product	Source
16215	E27 1 x 30 W Max Halogen (LED/FLUORESCENT bulbs compatible)

Accessory	Description
14930	Outer casing
14931	Pegs

**Oh! Smash\_FL65** | 220-240 V | E27

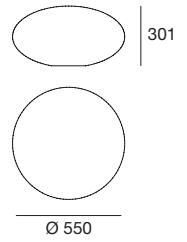

Product	Source
16218	E27 1 x 46 W Max Halogen (LED/FLUORESCENT bulbs compatible)

Accessory	Description
14930	Outer casing
14931	Pegs

# Ohps

Diffusore in polietilene.  
Base in policarbonato bianco.



353

265

Polyethylene diffuser.  
White polycarbonate base.





**Ohps\_FL65 LED | 220-240 V | topLED 7 W DC - 8 W AC**

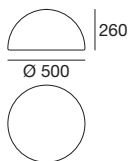

Product	Cct	Cri	lm S	lm D	Optics
16384	3000	80	1022	847	Diffused

**Accessory Description**

14930	Outer casing
14931	Pegs
14100	Anti-theft

**Ohps\_FL65 LED | 220-240 V | topLED 13 W DC - 15 W AC**

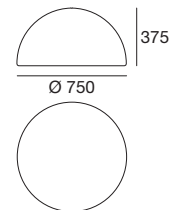

Product	Cct	Cri	lm S	lm D	Optics
16385	3000	80	1930	1588	Diffused

**Accessory Description**

14930	Outer casing
14931	Pegs
14100	Anti-theft

**Ohps\_FL65 E27 | 220-240 V | E27**

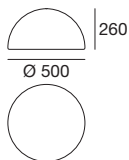

Product	Source
16380	E27 1 x 30 W Max Halogen (LED/FLUORESCENT bulbs compatible)

**Accessory Description**

14930	Outer casing
14931	Pegs
14100	Anti-theft

**Ohps\_FL65 E27 | 220-240 V | E27**

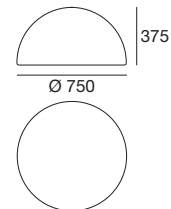

Product	Source
16382	E27 1 x 46 W Max Halogen (LED/FLUORESCENT bulbs compatible)

**Accessory Description**

14930	Outer casing
14931	Pegs
14100	Anti-theft

**Finishes**

White

**Outdoor Floor**

# Peggy

Diffusore in polietilene.  
Base in policarbonato bianco.

Polyethylene diffuser.  
White polycarbonate base.



**Peggy\_FL | 220-240 V | GU10**

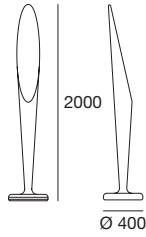

Product	Source
16201	GU10 1 x 42 W Max Halogen (LED bulbs compatible)

Accessory	Description
14937	Pegs
10013	Weight
14020	Anti-theft
14991	IP68 kit

**Peggy\_FL | 220-240 V | E27**

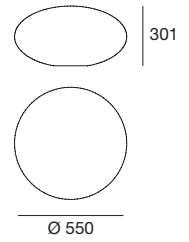

Product	Source
16202	E27 1 x 20 W Max Fluorescent (LED bulbs compatible max ø 55 mm)

Accessory	Description
14937	Pegs
10013	Weight
14020	Anti-theft
14991	IP68 kit

# Pistillo

Corpo in metallo verniciato nero o dark brown raggrinzante.  
Testa in alluminio. Diffusore in resina poliuretanica bianca.

Body in wrinkle effect black or dark brown painted metal.  
Aluminium head. Diffuser in white polyurethane resin.



**Pistillo** | topLED 4 W DC 24 V

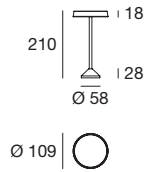

Product	Cct	Cri	lm S	lm D	Optics
8940M	2700	80	350	247	Diffused
8943M					
8940	3000	80	375	266	Diffused
8943					

**Electronics Description**

<b>KIT0018</b>	ON/OFF Driver 24V (1-2 art.)
<b>KIT0116</b>	ON/OFF Driver 24V (1-6 art.)

**Accessory Description**

<b>14992</b>	IP68 kit
<b>KIT77</b>	Pegs

**Pistillo** | topLED 4 W DC 24 V

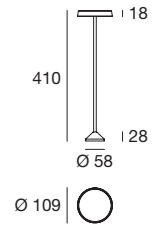

Product	Cct	Cri	lm S	lm D	Optics
8941M	2700	80	350	247	Diffused
8944M					
8941	3000	80	375	266	Diffused
8944					

**Electronics Description**

<b>KIT0018</b>	ON/OFF Driver 24V (1-2 art.)
<b>KIT0116</b>	ON/OFF Driver 24V (1-6 art.)

**Accessory Description**

<b>14992</b>	IP68 kit
<b>KIT77</b>	Pegs

**Pistillo** | topLED 4 W DC 24 V

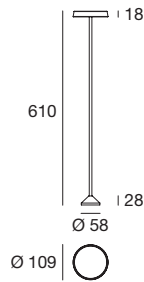

Product	Cct	Cri	lm S	lm D	Optics
8942M	2700	80	350	247	Diffused
8945M					
8942	3000	80	375	266	Diffused
8945					

**Electronics Description**

<b>KIT0018</b>	ON/OFF Driver 24V (1-2 art.)
<b>KIT0116</b>	ON/OFF Driver 24V (1-6 art.)

**Accessory Description**

<b>14992</b>	IP68 kit
<b>KIT77</b>	Pegs

**Example of surface installation**

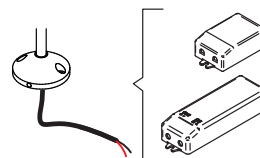

**KIT0018**  
Driver 1-2 art. (not included)

**KIT0116**  
Driver 1-6 art. (not included)

**Example of installation with peg**

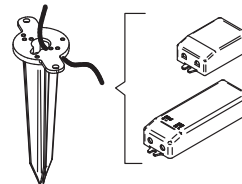

**KIT0018**  
Driver 1-2 art. (not included)

**KIT0116**  
Driver 1-6 art. (not included)

**Finishes**



**Outdoor Floor**



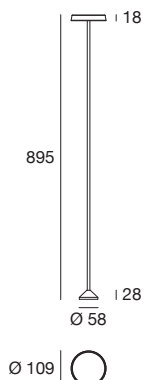

Product	Cct	Cri	Im S	Im D	Optics
8946M	2700	80	350	247	Diffused
8947M					
8946	3000	80	375	266	Diffused
8947					

**Electronics Description**

KIT0018	ON/OFF Driver 24V (1-2 art.)
KIT0116	ON/OFF Driver 24V (1-6 art.)

**Accessory Description**

14992	IP68 kit
KIT77	Pegs

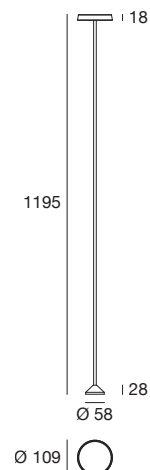

Product	Cct	Cri	Im S	Im D	Optics
8948M	2700	80	350	247	Diffused
8949M					
8948	3000	80	375	266	Diffused
8949					

**Electronics Description**

KIT0018	ON/OFF Driver 24V (1-2 art.)
KIT0116	ON/OFF Driver 24V (1-6 art.)

**Accessory Description**

14992	IP68 kit
KIT77	Pegs

**Example of surface installation**

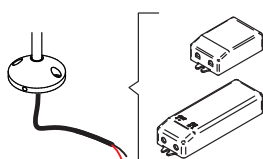

**KIT0018**  
Driver 1-2 art. (not included)

**KIT0116**  
Driver 1-6 art. (not included)

**Example of installation with peg**

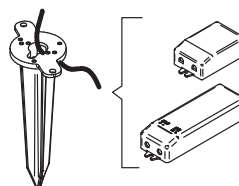

**KIT0018**  
Driver 1-2 art. (not included)

**KIT0116**  
Driver 1-6 art. (not included)

# Texo

Corpo in pressofusione di alluminio. Flangia in acciaio inox.  
Diffusore in cristallo extraclear carrabile.

Die-cast aluminium body. Stainless steel flange.  
Drive-over extraclear glass diffuser.

## Texo\_RJ | 220-240 V | GU10

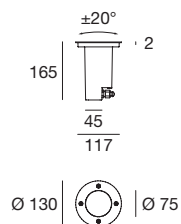

### Product Source

**52901** | GU10  
1 x 35 W Max Halogen  
(LED bulbs compatible)

### Accessory Description

**52700** | Outer casing  
**84893** | Terminal boxes for IP68 joints  
**84894** | Resin-potted

## Texo\_QJ | 220-240 V | GU10

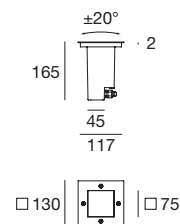

### Product Source

**52951** | GU10  
1 x 35 W Max Halogen  
(LED bulbs compatible)

### Accessory Description

**52700** | Outer casing  
**84893** | Terminal boxes for IP68 joints  
**84894** | Resin-potted





# Vision



355

Corpo in pressofusione di alluminio.

Die-cast aluminium body.

## Vision\_1 | 220-240 V | GU10

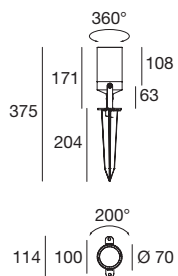

Product	Source
51585	GU10
51586	1 x 35 W Max Halogen (LED bulbs compatible)

## Vision\_2 | 220-240 V | GU10

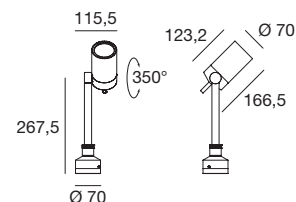

Product	Source
51395	GU10
51396	1 x 50 W Max Halogen (LED bulbs compatible)

Accessory	Description
50370	Pegs













































### Finishes

Grey    Dark Brown

### Outdoor Floor

385

# How to read symbols

	Installazione in ambiente interno Indoor installation		Driver non incluso Driver not included
	Installazione in ambiente esterno Outdoor installation		Classe I - classe di isolamento elettrico (IEC) Class I - IEC protection class
	Installazione a parete Wall mounting		Classe II - classe di isolamento elettrico (IEC) Class II - IEC protection class
	Installazione a terra Ground mounting		Classe III - classe di isolamento elettrico (IEC) Class III - IEC protection class
	Installazione a soffitto Ceiling mounting		C.C. Constant Current
	Installazione a parete o a terra Wall or ground mounting		C.V. Constant Voltage
	Installazione a soffitto o a parete Ceiling or wall mounting		Push DIM Push DIM
	Installazione a soffitto, a parete o a terra Ceiling, wall or ground mounting		Phase-cut Phase-cut
	Installazione a soffitto o a terra Ceiling or ground mounting		DALI PUSH Digital Addressable Lighting Interface
	Installazione ad incasso Recessed mounting		DMX RDM RDM, DMX 512
	Doppia emissione Double emission		Sensore P.I.R. P.I.R. Sensor
	Sistema a cavi Cable system		UGR Unified Glare Rating
	Indice di protezione (IEC 60529) da corpi estranei e acqua Protection index (IEC 60529) against foreign bodies and water		Durata accensione Power-on duration
	Indice di protezione sul vano ottico Optical compartment protection index		Sensore ON/OFF senza contatto Contactless ON/OFF sensor
	Apparecchio carrabile Carriageable device		Touch DIM Touch DIM
	Acciaio inossidabile Stainless steel		Batteria Battery
	Foro d'installazione circolare Circular installation hole		Intensità luminosa luce di emergenza Emergency light intensity
	Foro d'installazione quadrangolare Square installation hole		DW Dynamic White
	Fascio luminoso orientabile Directional light beam		L'alimentatore non passa nel foro di installazione The power supply does not switch into the installation hole
	Fascio luminoso basculante Tilting light beam		
	Disponibile in versione emergenza Emergency version available		
	Cavo d'alimentazione incluso Power supply cable included		
	Driver incluso Driver included		

Tutti gli articoli sono in classe energetica A++.

Gli schemi di collegamento per gli articoli dell'elettronica sono disponibili all'interno della documentazione tecnica.

All articles belong to energy class A++.

The connection diagrams for electronics articles are included in the technical documentation.

## Suffixes

_P	Pendant Luminaires	_C	Ceiling	_SQ	Square Surface	_PR	Round Pendant Luminaires
_S	Surface	_Q	Square	_SB	Rectangular Surface	_PB	Rectangular Pendant Luminaires
_W	Wall	_J	Adjustable	_TAB	Table	_RJ	Round Adjustable
_B	Rectangular	-C	Cable	_FL	Floor	_QJ	Square Adjustable
_R	Round	_SR	Round Surface	_PB	Rectangular Pendant Luminaires	_WJ	Wall Adjustable

# Finishes

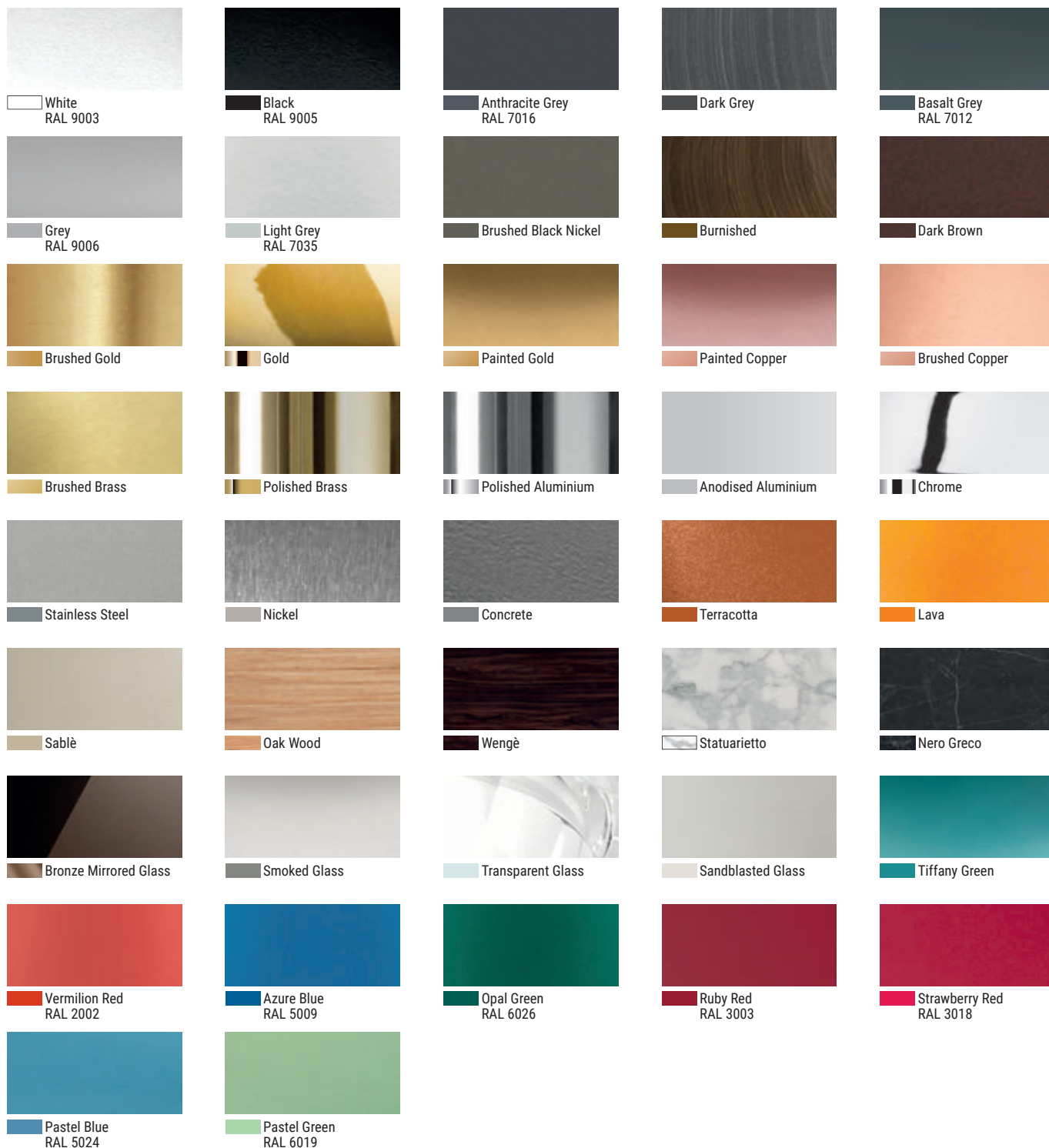

I disegni, le quote, i materiali ed i colori del presente catalogo si intendono a titolo indicativo. Nell'interesse della clientela, l'Azienda si riserva il diritto di modificare i modelli in ogni momento senza l'obbligo di preavviso.

"Linealight Group" si riserva il diritto, senza alcun preavviso di modificare le caratteristiche dei propri prodotti come la disponibilità degli stessi in qualunque momento. Tutti i prodotti, relativi dati tecnici, illustrazioni e informazioni presenti sul catalogo non sono vincolanti per "Linealight Group". "Linealight Group" non risponderà di eventuali errori illustrativi, testuali e/o di traduzione. Ulteriori caratteristiche dei prodotti sono contenute nelle relative schede tecniche e fogli istruzioni. Il presente catalogo è tutelato dalla legge sui diritti d'autore (legge 22/04/1941 n. 633 e della legge 14/12/1942 n. 1485: di esso è proibita ogni riproduzione totale o anche parziale). Tutti i valori riportati a catalogo sono valori di misurazione. I dati di flusso, CCT e potenza sono passibili di tolleranze di +/- 10%.

The drawings, the measurements, the materials and the colours in this catalogue are understood to be indicative. In the interest of the clientele, the company reserves the right to modify the models at any time and without any obligation of advance notice.

"Linea Light Group" reserves the right, without any advance notice, to change the characteristics of their products, as well as the availability of the same at any time. No product, relative technical data, illustrations and information in the catalogue are binding for "Linea Light Group". "Linea Light Group" will not be held liable for any illustration, text and/or translation errors. More product characteristics are contained in the relative technical data sheets and instruction sheets. This catalogue is protected by copyright (law 22/04/1941 No. 633 and law 14/12/1942 No. 1485: this prohibits any reproduction, total or even partial).

All values indicated in the catalogue are measured values. There is a +/- 10% tolerance for the flow, CCT and power data.

# Code index

Code	Product	Page	Code	Product	Page	Code	Product	Page
1140	Curvè LED	153	7628	Squash_FL	271	7946	Squash_TAB	271
1141	Curvè LED	153	7655	Rose_P	89	7947	Squash_TAB	271
1143	Curvè LED	153	7656	Rose_S	205	7948	Squash_P	99
1144	Curvè LED	153	7657	Rose_P	89	7951	Squash_S	218
1146	Curvè LED	153	7658	Rose_S	205	7956	Bart_W Switch	123
1147	Curvè LED	153	7805	MyWhite_R	341	7957	Bart_W Switch	123
1190	Curvè LED	153	7805N	MyWhite_R	341	7972	Beebo_W Switch	127
1191	Curvè LED	153	7806	MyWhite_R	341	7973	Beebo_W Switch	127
1192	Curvè LED	153	7806E	MyWhite_R Emergency	341	7974	Beebo_W Switch	127
6986	Zig zag_W	237	7806N	MyWhite_R	341	8026	MiniWhite Cover_R	349
6989	Zig zag_W	237	7806NE	MyWhite_R Emergency	341	8028	MiniWhite_R	347
6990	Zig zag_W	237	7806NS	MyWhite_R Motion Sensor	341	8028N	MiniWhite_R	347
6991	Zig zag_P	113	7806S	MyWhite_R Motion Sensor	341	8029	MiniWhite_Q	347
6994	Zig zag_P	113	7807	MyWhite_Q	343	8029N	MiniWhite_Q	347
6995	Zig zag_P	113	7807N	MyWhite_Q	343	8030	MiniWhite Cover_R	349
6996	Zig zag_W	237	7808	MyWhite_Q	343	8031	MiniWhite Cover_Q	349
6999	Zig zag_W	237	7808E	MyWhite_Q Emergency	343	8032	MiniWhite Cover_Q Double	349
7001	Zig zag_W	237	7808N	MyWhite_Q	343	8033	MiniWhite Cover_Q	349
7220	Snake_W1	215	7808NE	MyWhite_Q Emergency	343	8034	MiniWhite Cover_Q Double	349
7221	Snake_W1	215	7808NS	MyWhite_Q Motion Sensor	343	8200	Straight_P1	103
7223	Snake_W1	215	7808S	MyWhite_Q Motion Sensor	343	8201	Straight_P1	103
7224	Snake_W1	215	7809	MyWhite_B	345	8202	Straight_P3	103
7226	Snake_W3	217	7809N	MyWhite_B	345	8203	Straight_P3	103
7227	Snake_W3	217	7810	MyWhite_B	345	8204	Straight_P1	103
7229	Snake_W2	217	7810E	MyWhite_B Emergency	345	8205	Straight_P1	103
7230	Snake_W2	217	7810N	MyWhite_B	345	8206	Straight_P3	103
7232	Snake_W1 Switch	215	7810NE	MyWhite_B Emergency	345	8207	Straight_P3	103
7233	Snake_W1 Switch	215	7810NS	MyWhite_B Motion Sensor	345	8208	Straight_W	219
7234	Snake_W3 Switch	217	7810S	MyWhite_B Motion Sensor	345	8209	Straight_W	219
7235	Snake_W3 Switch	217	7836	Mille_W1 LED	185	8210	Straight_W	219
7289	Zig zag_S	237	7838	Mille_W1 LED	185	8211	Straight_W	219
7290	Zig zag_S	237	7840	Mille_W1 LED	185	8227	Box_SQ	135
7291	Zig zag_S	237	7842	Mille_W1 LED	185	8227N	Box_SQ	135
7400	Zig zag_S	237	7844	Mille_W1 LED	186	8229	Box_SQ	135
7401	Zig zag_S	237	7846	Mille_W1 LED	186	8229N	Box_SQ	135
7402	Zig zag_S	237	7848	Mille_W1 LED	186	8231	Box_SQ	135
7485	Dublight_W	157	7850	Mille_W2 LED	186	8231N	Box_SQ	135
7486	Dublight_W	157	7852	Mille_SB LED	187	8233	Box_SQ	135
7487	Dublight_W	157	7854	Mille_SB LED	187	8233N	Box_SQ	135
7488	Dublight_SQ	155	7887	Dublight_C TAB	253	8236	Box_SR	133
7489	Dublight_SQ	155	7888	Dublight_C TAB	253	8236N	Box_SR	133
7490	Dublight_SQ	155	7889	MyWhite_U	347	8238	Box_SR	133
7491	Dublight_SB	155	7890	MyWhite_U	347	8238N	Box_SR	133
7493	Dublight_PQ	63	7904	Kioo	181	8240	Box_SR	133
7494	Dublight_PB	63	7905	Kioo	181	8240N	Box_SR	133
7495	Dublight_TAB	253	7906	Kioo	181	8242	Box_SR	133
7496	Dublight_FL	253	7907	Kioo	181	8242N	Box_SR	133
7618	One to one_S	194	7908	Skinny	213	8255	Box_W2 Bi Emission	142
7619	One to one_C	46	7909	Skinny	213	8255M	Box_W2 Bi Emission	142
7626	Squash_S	218	7910	Skinny	213	8255N	Box_W2 Bi Emission	142
7627	Squash_P	99	7911	Skinny	213	8256	Box_W2 Bi Emission	142

Code	Product	Page	Code	Product	Page	Code	Product	Page
8256M	Box_W2 Bi Emission	142		Crew_2 (pendant kit version)	61	8361	Poe_Plus	87
8256N	Box_W2 Bi Emission	142	8288	Crew_2	149	8363	Poe_Plus	87
8257	Box_W2 Bi Emission	143		Crew_2 (pendant kit version)	61	8364	Poe_Plus	87
8257M	Box_W2 Bi Emission	143	8289	Crew_2	149	8365	Joshua	261
8257N	Box_W2 Bi Emission	143		Crew_2 (pendant kit version)	61	8366	Joshua	261
8258	Box_W2 Bi Emission	143	8292	Crew_2	149	8405	Circular	145
8258M	Box_W2 Bi Emission	143		Crew_2 (pendant kit version)	61	8406	Circular	145
8258N	Box_W2 Bi Emission	143	8293	Crew_2	149	8409	Circular	145
8259	Box_SB	136		Crew_2 (pendant kit version)	61	8410	Circular	145
8259N	Box_SB	136	8294	Crew_2	149	8413	Circular	145
8260	Box_SB	136		Crew_2 (pendant kit version)	61	8414	Circular	145
8260N	Box_SB	136	8295	Crew_2	149	8420	Outlook_P	79
8261	Box_W2 Bi Emission	142		Crew_2 (pendant kit version)	61	8422	Outlook-C	305
8261M	Box_W2 Bi Emission	142	8296	Crew_2	149	8425	Trix-C30_1	311
8261N	Box_W2 Bi Emission	142		Crew_2 (pendant kit version)	61	8426	Trix-C30_1	311
8262	Box_W2 Bi Emission	142	8299	Crew_2	149	8427	Trix-C30_2	311
8262M	Box_W2 Bi Emission	142		Crew_2 (pendant kit version)	61	8428	Trix-C30_2	311
8262N	Box_W2 Bi Emission	142	8300	Crew_2	149	8429	Trix-C	311
8263	Box_W2 Bi Emission	143		Crew_2 (pendant kit version)	61	8430	Trix-C	311
8263M	Box_W2 Bi Emission	143	8301	Crew_2	149	8431	Trix-C	311
8263N	Box_W2 Bi Emission	143		Crew_2 (pendant kit version)	61	8432	Trix-C30_1	311
8264	Box_W2 Bi Emission	143	8302	Crew_2	149	8433	Trix-C30_2	311
8264M	Box_W2 Bi Emission	143		Crew_2 (pendant kit version)	61	8442	Beebo-C30	295
8264N	Box_W2 Bi Emission	143	8303	Crew_2	149	8443	Beebo-C30	295
8265	Straight_W	219	8321	Chobin65 GX53	335	8445	Circular-C	297
8266	Straight_W	219	8322	Chobin65 LED	335	8446	Circular-C	297
	Crew_1 (pendant kit version)	59	8325	Tara_Q	221	8447	Circular-C	297
8270	Crew_1	147	8326	Tara_Q	221	8460	Beebo_S	125
	Crew_1 (pendant kit version)	59	8328	Tara_Q	221	8461	Beebo_S	125
8271	Crew_1	147	8329	Tara_Q	221	8462	Beebo_S	125
	Crew_1 (pendant kit version)	59	8331	Tara_Q	221	8466	Bart_S	123
8272	Crew_1	147	8332	Tara_Q	221	8467	Bart_S	123
	Crew_1 (pendant kit version)	59	8334	Tara_R	221	8470	Outlook_C	47
8275	Crew_1	147	8335	Tara_R	221	8472	Outlook_S	195
	Crew_1 (pendant kit version)	59	8337	Tara_R	221	8500	Poe_W	197
8276	Crew_1	147	8338	Tara_R	221	8501	Poe_W	197
	Crew_1 (pendant kit version)	59	8340	Tara_R	221	8503	Poe_W	197
8277	Crew_1	147	8341	Tara_R	221	8504	Poe_W	197
	Crew_1 (pendant kit version)	59	8345	Poe_FL	267	8505	Straight_P1	103
8280	Crew_1	147	8346	Poe_FL	267	8506	Straight_P1	103
	Crew_1 (pendant kit version)	59	8348	Poe_FL	267	8507	Straight_P3	103
8281	Crew_1	147	8349	Poe_FL	267	8508	Straight_P3	103
	Crew_1 (pendant kit version)	59	8350	Poe_P1	85	8650	TU-V-C	313
8282	Crew_1	147	8351	Poe_P1	85	8660	Bond_Head	359
	Crew_2 (pendant kit version)	61	8353	Poe_P1	85	8663	Bond	359
8285	Crew_2	149	8354	Poe_P1	85	8666	Bond	359
	Crew_2 (pendant kit version)	61	8355	Poe_P3	87	8669	Bond	359
8286	Crew_2	149	8356	Poe_P3	87	8672	MyWhite Bond_W	349
	Crew_2 (pendant kit version)	61	8358	Poe_P3	87	8704	Cable system accessories	316
8287	Crew_2	149	8359	Poe_P3	87	8705	Cable system accessories	316
	Crew_2 (pendant kit version)	61	8360	Poe_Plus	87	8706	Cable system accessories	316

# Code index

Code	Product	Page	Code	Product	Page	Code	Product	Page
8711	Cable system accessories	316	8833	Gypsum Coloring_Q3	29	8917	Box_W1 Mono Emission	139
8712	Cable system accessories	316	8834	Gypsum Coloring_Q3	29	8917M	Box_W1 Mono Emission	139
8713	Cable system accessories	316	8835	Gypsum Coloring Power_R	27	8918	Box_W1 Mono Emission	139
8720	Cable system accessories	318	8836	Gypsum Coloring Power_R	27	8918M	Box_W1 Mono Emission	139
8721	Cable system accessories	318	8837	Gypsum Coloring Power_Q	27	8919	Box_W1 Mono Emission	139
8722	Cable system accessories	318	8838	Gypsum Coloring Power_Q	27	8919M	Box_W1 Mono Emission	139
8729	Cable system accessories	318	8840	TU-V	107	8920	Aruba_S	122
8730	Cable system accessories	318	8841	TU-V	107	8921	Aruba_S	122
8731	Cable system accessories	318	8842	TU-V	107	8922	Aruba_S	122
8740	Minion_S1	189	8843	TU-V	107	8923	Aruba_S	122
8742	Minion_S1	189	8844	TU-V	107	8924	Aruba_S	122
8744	Minion_S1	189	8845	TU-O	105	8925	Aruba_S	122
8746	Minion_S1	189	8846	TU-O	105	8926	Aruba_S	122
8748	Minion_S2	189	8850	TU-Top	233	8927	Aruba_S	122
8750	Minion_S2	189	8851	TU-Top	233	8928	Aruba_P	53
8752	Minion_S2	189	8861	Gypsum_01	33	8929	Aruba_P	53
8754	Minion_S2	189	8861N	Gypsum_01	33	8930	Aruba_P	53
8770	Box_W1 Mono Emission	138	8863	Gypsum_SQ	39	8931	Aruba_P	53
8770M	Box_W1 Mono Emission	138	8863N	Gypsum_SQ	39	8932	Aruba_P	53
8770N	Box_W1 Mono Emission	138	8864	Gypsum_SR	39	8933	Aruba_P	53
8771	Box_W1 Mono Emission	138	8864N	Gypsum_SR	39	8934	Aruba_P	53
8771M	Box_W1 Mono Emission	138	8865	Gypsum_QC2	34	8935	Aruba_P	53
8771N	Box_W1 Mono Emission	138	8865N	Gypsum_QC2	34	8936	Antille_P	51
8772	Box_W1 Mono Emission	138	8866	Gypsum_R	31	8937	Antille_P	51
8772M	Box_W1 Mono Emission	138	8866N	Gypsum_R	31	8938	Antille_P	51
8772N	Box_W1 Mono Emission	138	8867	Gypsum_Eye1	31	8939	Antille_P	51
8773	Box_W1 Mono Emission	138	8867N	Gypsum_Eye1	31	8940	Pistillo	381
8773M	Box_W1 Mono Emission	138	8870	Gypsum_QRD	35	8940M	Pistillo	381
8773N	Box_W1 Mono Emission	138	8870N	Gypsum_QRD	35	8941	Pistillo	381
8774	Box_W1 Mono Emission	139	8871	Gypsum_QC3	36	8941M	Pistillo	381
8774M	Box_W1 Mono Emission	139	8871N	Gypsum_QC3	36	8942	Pistillo	381
8774N	Box_W1 Mono Emission	139	8872	Gypsum_D1	37	8942M	Pistillo	381
8775	Box_W1 Mono Emission	139	8873	Gypsum_D2	37	8943	Pistillo	381
8775M	Box_W1 Mono Emission	139	8880	Antille_S	121	8943M	Pistillo	381
8775N	Box_W1 Mono Emission	139	8881	Antille_S	121	8944	Pistillo	381
8776	Box_W1 Mono Emission	139	8882	Antille_S	121	8944M	Pistillo	381
8776M	Box_W1 Mono Emission	139	8883	Antille_S	121	8945	Pistillo	381
8776N	Box_W1 Mono Emission	139	8885	Antille_S	121	8945M	Pistillo	381
8777	Box_W1 Mono Emission	139	8886	Antille_S	121	8946	Pistillo	383
8777M	Box_W1 Mono Emission	139	8887	Antille_S	121	8946M	Pistillo	383
8777N	Box_W1 Mono Emission	139	8888	Antille_S	121	8947	Pistillo	383
8780	Minion_P1	71	8912	Box_W1 Mono Emission	138	8947M	Pistillo	383
8782	Minion_P1	71	8912M	Box_W1 Mono Emission	138	8948	Pistillo	383
8784	Minion_P1	71	8913	Box_W1 Mono Emission	138	8948M	Pistillo	383
8786	Minion_P1	71	8913M	Box_W1 Mono Emission	138	8949	Pistillo	383
8815	Gypsum Coloring_R1	28	8914	Box_W1 Mono Emission	138	8949M	Pistillo	383
8819	Gypsum Coloring_R1	28	8914M	Box_W1 Mono Emission	138	9015	Tara_B	225
8823	Gypsum Coloring_Q1	28	8915	Box_W1 Mono Emission	138	9016	Tara_B	225
8827	Gypsum Coloring_Q1	28	8915M	Box_W1 Mono Emission	138	9018	Tara_B	225
8831	Gypsum Coloring_R3	29	8916	Box_W1 Mono Emission	139	9019	Tara_B	225
8832	Gypsum Coloring_R3	29	8916M	Box_W1 Mono Emission	139	9021	Tara_B	225

Code	Product	Page	Code	Product	Page	Code	Product	Page
9022	Tara_B	225	9150	Igloo_W ON/OFF	179	9196M	Satori_P	91
9024	Tara Maxi	227	9151	Igloo_W ON/OFF	179	9197	Satori_P	91
9025	Tara Maxi	227	9152	Igloo_W ON/OFF	179	9197M	Satori_P	91
9027	Tara Mega	227	9160	Polo_S	199	9198	Satori_P	91
9028	Tara Mega	227		Polo_S	280	9198M	Satori_P	91
9035	Regolo 160	201	9161	Polo_S	199	9210	Rossini_S	211
9036	Regolo 160	201		Polo_S	280	9211	Rossini_S	211
9037	Regolo 160	201	9162	Polo_P	88	9212	Rossini_S	211
9040	Regolo 240	201	9163	Polo_P	88	9214	Rossini_S	211
9041	Regolo 240	201	9164	Polo_P	88	9215	Sinfonia system	288
9042	Regolo 240	201	9165	Polo_P	88	9216	Sinfonia system	288
9045	Regolo 320	201	9166	Polo-C_660	309	9217	Sinfonia system	288
9046	Regolo 320	201	9167	Polo-C_960	309	9219	Sinfonia system	288
9047	Regolo 320	201	9170	Switch	354	9220	Rossini_TAB	269
9095	Butler	361	9171	Switch	354	9221	Rossini_TAB	269
9124	Miguel	69	9172	Switch	354	9222	Rossini_TAB	269
9124M	Miguel	69	9174	Satori_W	207	9224	Rossini_TAB	269
9125	Miguel	69	9174M	Satori_W	207	9225	Rossini_P	97
9125M	Miguel	69	9175	Satori_W	207	9226	Rossini_P	97
9126	Miguel	69	9175M	Satori_W	207	9227	Rossini_P	97
9126M	Miguel	69	9176	Satori_W	207	9229	Rossini_P	97
9127	Miguel	69	9176M	Satori_W	207	9230	Verdi	97
9127M	Miguel	69	9177	Satori_W	207	9231	Verdi	97
9128	Miguel	69	9177M	Satori_W	207	9232	Verdi	97
9128M	Miguel	69	9178	Satori_W	207	9234	Verdi	97
9129	Miguel	69	9178M	Satori_W	207	9235	Vivaldi_W	211
9129M	Miguel	69	9179	Satori_W	207	9236	Vivaldi_W	211
9135	Igloo_S ON/OFF	177	9179M	Satori_W	207	9237	Vivaldi_W	211
9136	Igloo_S ON/OFF	177	9180	Satori_W	207	9239	Vivaldi_W	211
9137	Igloo_S ON/OFF	177	9180M	Satori_W	207	9240	Vivaldi_P1	97
	Igloo_S DALI	177	9181	Satori_W	207	9241	Vivaldi_P1	97
9138	Igloo_S DALI (System config.)	276	9181M	Satori_W	207	9242	Vivaldi_P1	97
	Igloo_S DALI	177	9182	Satori_W	207	9244	Vivaldi_P1	97
9139	Igloo_S DALI (System config.)	276	9182M	Satori_W	207	9245	Vivaldi_P3	97
	Igloo_S DALI	177	9183	Satori_W	207	9246	Vivaldi_P3	97
9140	Igloo_S DALI (System config.)	276	9183M	Satori_W	207	9247	Vivaldi_P3	97
	Igloo_S DALI	177	9184	Satori_W	207	9249	Vivaldi_P3	97
9141	Igloo_S DALI (System config.)	276	9184M	Satori_W	207	9250	Puccini	95
	Igloo_S DALI	177	9185	Satori_W	207	9251	Puccini	95
9142	Igloo_S DALI (System config.)	276	9185M	Satori_W	207	9252	Puccini	95
	Igloo_S DALI	177	9189	Satori_S	209	9254	Puccini	95
9143	Igloo_S DALI (System config.)	276	9189M	Satori_S	209	9255	Puccini	95
	Igloo_S DALI	177	9190	Satori_S	209	9256	Puccini	95
9144	Igloo_S DALI (System config.)	276	9190M	Satori_S	209	9257	Puccini	95
	Igloo_S DALI	177	9191	Satori_S	209	9259	Puccini	95
9145	Igloo_S DALI (System config.)	276	9191M	Satori_S	209	9260	Puccini	95
	Igloo_S DALI	177	9192	Satori_S	209	9261	Puccini	95
9146	Igloo_S DALI (System config.)	276	9192M	Satori_S	209	9262	Puccini	95
	Igloo_W ON/OFF	179	9195	Satori_P	91	9264	Puccini	95
9148	Igloo_W ON/OFF	179	9195M	Satori_P	91	9265	Puccini	95
9149	Igloo_W ON/OFF	179	9196	Satori_P	91	9266	Puccini	95

# Code index

Code	Product	Page	Code	Product	Page	Code	Product	Page
9267	Puccini	95	9376	Birba_S	129	9478	Birba_FL	243
9269	Puccini	95	9379	Birba_S	129	9490	Sinfonia system	288
9270	Puccini	95	9381	Birba_S	129	9491	Sinfonia system	288
9271	Puccini	95	9382	Birba_S	129	9492	Sinfonia system	288
9272	Puccini	95	9385	Birba_S	129	9494	Sinfonia system	288
9274	Puccini	95	9387	Birba_S	129	9495	Sinfonia system	288
9296	Reiki	203	9388	Birba_S	129	9496	Sinfonia system	288
9296M	Reiki	203	9391	Birba_W1 Mono emission	131	9497	Sinfonia system	288
9297	Reiki	203	9393	Birba_W1 Mono emission	131	9499	Sinfonia system	288
9297M	Reiki	203	9394	Birba_W1 Mono emission	131	9500	Sinfonia system	288
9298	Reiki	203	9397	Birba_W2 Bi emission	131	9501	Sinfonia system	288
9298M	Reiki	203	9399	Birba_W2 Bi emission	131	9502	Sinfonia system	288
9299	Reiki	203	9400	Birba_W2 Bi emission	131	9504	Sinfonia system	288
9299M	Reiki	203	9403	Birba_P	57	9505	Sinfonia system	287
9315	Antigua_FL	241	9405	Birba_P	57	9506	Sinfonia system	287
9316	Antigua_FL	241	9406	Birba_P	57	9507	Sinfonia system	287
9320	Lira_FL	363	9409	Birba_P	57	9509	Sinfonia system	287
9321	Lira_FL	363	9411	Birba_P	57	9510	Sinfonia system	287
9322	Lira_PR	323	9412	Birba_P	57	9511	Sinfonia system	287
9323	Lira_PR	323	9415	Birba_P	57	9512	Sinfonia system	287
9324	Lira_SR	337	9417	Birba_P	57	9514	Sinfonia system	287
9325	Lira_SR	337	9418	Birba_P	57	9515	Sinfonia system	287
9330	Lira_PB	323	9421	Birba_S	129	9516	Sinfonia system	287
9331	Lira_PB	323	9423	Birba_S	129	9517	Sinfonia system	287
9332	Lira_Cable	338	9424	Birba_S	129	9519	Sinfonia system	287
9333	Lira_Cable	338	9427	Birba_S	129	9520	Sinfonia system	287
9334	Lira_SB	337	9429	Birba_S	129	9521	Sinfonia system	287
9335	Lira_SB	337	9430	Birba_S	129	9522	Sinfonia system	287
9336	Lira_SB	337	9433	Birba_S	129	9524	Sinfonia system	287
9337	Lira_SB	337	9435	Birba_S	129	9532	Box_W2 Bi Emission	142
9338	Lira_W	339	9436	Birba_S	129	9532M	Box_W2 Bi Emission	142
9339	Lira_W	339	9439	Birba_W1 Mono emission	131	9533	Box_W2 Bi Emission	142
9340	Lira_W	339	9441	Birba_W1 Mono emission	131	9533M	Box_W2 Bi Emission	142
9341	Lira_W	339	9442	Birba_W1 Mono emission	131	9534	Box_W2 Bi Emission	142
9345	Dama	249	9445	Birba_W2 Bi emission	131	9534M	Box_W2 Bi Emission	142
9346	Dama	249	9447	Birba_W2 Bi emission	131	9535	Box_W2 Bi Emission	142
9347	Dama	249	9448	Birba_W2 Bi emission	131	9535M	Box_W2 Bi Emission	142
9349	Dama	249	9451	Birba_C	23	9536	Box_W2 Bi Emission	143
9350	Dama	249	9453	Birba_C	23	9536M	Box_W2 Bi Emission	143
9351	Dama	249	9454	Birba_C	23	9537	Box_W2 Bi Emission	143
9355	Birba_P	57	9457	Birba_C	23	9537M	Box_W2 Bi Emission	143
9357	Birba_P	57	9459	Birba_C	23	9538	Box_W2 Bi Emission	143
9358	Birba_P	57	9460	Birba_C	23	9538M	Box_W2 Bi Emission	143
9361	Birba_P	57	9463	Birba_TAB	243	9539	Box_W2 Bi Emission	143
9363	Birba_P	57	9465	Birba_TAB	243	9539M	Box_W2 Bi Emission	143
9364	Birba_P	57	9466	Birba_TAB	243	9540	Box_W1 Mono Emission	138
9367	Birba_P	57	9469	Birba_FL	243	9540M	Box_W1 Mono Emission	138
9369	Birba_P	57	9471	Birba_FL	243	9540N	Box_W1 Mono Emission	138
9370	Birba_P	57	9472	Birba_FL	243	9541	Box_W1 Mono Emission	138
9373	Birba_S	129	9475	Birba_FL	243	9541M	Box_W1 Mono Emission	138
9375	Birba_S	129	9477	Birba_FL	243	9541N	Box_W1 Mono Emission	138



Code	Product	Page	Code	Product	Page	Code	Product	Page
9542	Box_W1 Mono Emission	139	9658	Alba	117	9758	Perla_P12	83
9542M	Box_W1 Mono Emission	139	9658M	Alba	117	9786	Bubble	25
9542N	Box_W1 Mono Emission	139	9659	Alba	117	9787	Bubble	25
9543	Box_W1 Mono Emission	139	9659M	Alba	117	9788	Bubble	25
9543M	Box_W1 Mono Emission	139	9662	Alba_W65	333	9789	Bubble	25
9543N	Box_W1 Mono Emission	139	9662M	Alba_W65	333	9790	Bubble	25
9545	Box_W2 Bi Emission	142	9663	Alba_W65	333	9791	Bubble	25
9545M	Box_W2 Bi Emission	142	9663M	Alba_W65	333	9792	Bubble	25
9545N	Box_W2 Bi Emission	142	9666	Gemini_S	165	9793	Bubble	25
9546	Box_W2 Bi Emission	142	9666M	Gemini_S	165	9794	Bubble	25
9546M	Box_W2 Bi Emission	142	9667	Gemini_S	165	9795	Bubble	25
9546N	Box_W2 Bi Emission	142	9667M	Gemini_S	165	9796	Bubble	25
9547	Box_W2 Bi Emission	143	9668	Gemini_S	165	9797	Bubble	25
9547M	Box_W2 Bi Emission	143	9668M	Gemini_S	165	9800	Halfpipe 2_W	173
9547N	Box_W2 Bi Emission	143	9669	Gemini_W1	167	9801	Halfpipe 2_W	173
9548	Box_W2 Bi Emission	143	9669M	Gemini_W1	167	9802	Halfpipe 2_W	173
9548M	Box_W2 Bi Emission	143	9670	Gemini_W1	167	9803	Halfpipe 2_W	173
9548N	Box_W2 Bi Emission	143	9670M	Gemini_W1	167	9804	Halfpipe 2_W	173
9595	Dubcolor	251	9671	Gemini_W1	167	9805	Halfpipe 2_W	173
9596	Dubcolor	251	9671M	Gemini_W1	167	9806	Halfpipe 2_W	173
9597	Dubcolor	251	9672	Gemini_W1	167	9807	Halfpipe 2_W	173
9598	Dubcolor	251	9672M	Gemini_W1	167	9808	Halfpipe 2_W	173
9599	Dubcolor	251	9673	Gemini_W1	167	9809	Halfpipe 2_P	65
9600	Dubcolor	251	9673M	Gemini_W1	167	9810	Halfpipe 2_P	65
9630	Duck_W	161	9674	Gemini_W1	167	9811	Halfpipe 2_P	65
9630M	Duck_W	161	9674M	Gemini_W1	167	9812	Halfpipe 2_P	65
9631	Duck_W	161	9675	Gemini_W2	167	9813	Halfpipe 2_P	65
9631M	Duck_W	161	9675M	Gemini_W2	167	9814	Halfpipe 2_P	65
9633	Duck_S	159	9676	Gemini_W2	167	9815	Halfpipe 2_FL	257
9633M	Duck_S	159	9676M	Gemini_W2	167	9816	Halfpipe 2_FL	257
9634	Duck_S	159	9677	Gemini_W2	167	9817	Halfpipe 2_FL	257
9634M	Duck_S	159	9677M	Gemini_W2	167	9853	Cable system accessories	316
9637	Yo-yo_P	111	9678	Gemini_TAB	255	9854	Cable system accessories	316
9637M	Yo-yo_P	111	9678M	Gemini_TAB	255	9855	lota-C	301
9638	Yo-yo_P	111	9679	Gemini_TAB	255	9856	lota-C	301
9638M	Yo-yo_P	111	9679M	Gemini_TAB	255	9857	lota-C	301
9639	Yo-yo_P	111	9727	Goose	169	9858	lota-C	301
9639M	Yo-yo_P	111	9727M	Goose	169	9859	lota-C	301
9640	Yo-yo_P	111	9728	Goose	169	9860	lota-C	301
9640M	Yo-yo_P	111	9728M	Goose	169	9861	lota-C30_1	303
9645	Yo-yo_W	235	9730	Goose	169	9862	lota-C30_1	303
9645M	Yo-yo_W	235	9730M	Goose	169	9863	lota-C30_2	303
9646	Yo-yo_W	235	9731	Goose	169	9864	lota-C30_2	303
9646M	Yo-yo_W	235	9731M	Goose	169	9865	lota-C30_3	303
9647	Yo-yo_W	235	9750	Perla_P9	83	9866	lota-C30_3	303
9647M	Yo-yo_W	235	9751	Perla_P9	83	9867	Eta-C	299
9648	Yo-yo_W	235	9752	Perla_P9	83	9868	Eta-C	299
9648M	Yo-yo_W	235	9753	Perla_P9	83	9869	Eta-C	299
9650	Camping	245	9755	Perla_P12	83	9870	Eta-C	299
9651	Camping	245	9756	Perla_P12	83	9871	Eta-C	299
9652	Camping	245	9757	Perla_P12	83	9872	Eta-C	299

# Code index

Code	Product	Page	Code	Product	Page	Code	Product	Page
9873	Cable system accessories	318	12224	Oh!_PM7 E27	75	16106	Oh!_P65 LED	325
9874	Cable system accessories	318	12225	Oh!_PM7 E27	75	16109	Oh!_S65 LED	351
9908	Eta	163	12380	Ohps_FL E27	265	16110	Oh!_P65 LED	325
9909	Eta	163	12381	Ohps_FL E27	265	16112	Oh!_S65 LED	351
9910	Eta	163	12386	Ohps_S E27	193	16113	Oh!_P65 LED	325
9911	Eta	163	12387	Ohps_S E27	193	16115	Oh!_P65 LED	325
9912	Eta	163	14020	Accessories	379	16130	Oh!_Mars E27	373
9913	Eta	163			367	16131	Oh!_Mars E27	373
9916	Eta-C30	299	14080	Accessories	369	16132	Oh!_Mars E27	373
9917	Eta-C30	299			371	16133	Oh!_Mars E27	373
9918	Eta-C30	299			373	16150	Oh!_FL65 E27	371
9919	Eta-C30	299			367	16160	Oh!_FL65 E27	371
9920	Eta-C30	299	14081	Accessories	369	16162	Oh!_FL65 E27	371
9921	Eta-C30	299			371	16164	Oh!_FL65 E27	371
		365			373	16168	Oh!_P65 E27	327
10013	Accessories	379			367	16169	Oh!_P65 E27	327
10015	Accessories	365	14082	Accessories	369	16170	Oh!_P65 E27	327
10114	Oh!_P LED	73			371	16180	Oh!_P65 E27	327
10115	Oh!-C1	307			373	16181	Oh!_S65 E27	351
10116	Oh!-C1	307	14100	Accessories	377	16183	Oh!_S65 E27	351
10382	Ohps_P E27	77			367	16185	Oh!_S65 E27	351
10383	Ohps_P E27	77			369	16190	Oh!_FL65 LED	369
12100	Oh!_FL E27	263			371	16191	Oh!_FL65 LED	369
12101	Oh!_P E27	74	14930	Accessories	373	16192	Oh!_FL65 LED	369
12102	Oh!_FL E27	263			375	16193	Oh!_FL65 LED	369
12103	Oh!_P E27	74			377	16201	Peggy_FL	379
12104	Oh!_FL E27	263			367	16202	Peggy_FL	379
12105	Oh!_P E27	74			369	16213	Oh! Smash_P65	329
12106	Oh!_FL E27	263	14931	Accessories	371	16214	Oh! Smash_S65	352
12107	Oh!_P E27	74			373	16215	Oh! Smash_FL65	375
12122	Oh!_S E27	191			375	16216	Oh! Smash_P65	329
12124	Oh!_S E27	191			377	16217	Oh! Smash_S65	352
12126	Oh!_S E27	191			365	16218	Oh! Smash_FL65	375
12131	Oh!_S LED	191			367	16227	Oh! Dynamic White	367
12132	Oh!_S LED	191	14937	Accessories	369	16228	Oh! Dynamic White	367
12133	Oh!_S LED	191			371	16229	Oh! Dynamic White	367
12135	Oh!_P LED	73			373	16230	Oh! Dynamic White	367
12136	Oh!_P LED	73			379	16380	Ohps_FL65 E27	377
12137	Oh!_P LED	73	14958	Electronics	365	16382	Ohps_FL65 E27	377
12138	Oh!_P LED	73			365	16384	Ohps_FL65 LED	377
12140	Oh!-C2_280	307	14991	Accessories	379	16385	Ohps_FL65 LED	377
12142	Oh!-C30_280	307			367	16386	Ohps_S65 E27	353
12145	Oh!-C30_380	307			369	16387	Ohps_S65 E27	353
12213	Oh! Smash_P E27	76			371			355
12214	Oh! Smash_S E27	192	14992	Accessories	373			385
12215	Oh! Smash_FL E27	264			381	50370	Accessories	385
12216	Oh! Smash_P E27	76			383	51365	Vision_WJ	355
12217	Oh! Smash_S E27	192	15111	Oh!_P65 LED	325	51366	Vision_WJ	355
12218	Oh! Smash_FL E27	264	16000	Marge_FL65 RGB LED	365	51395	Vision_2	385
12220	Oh!_PM3 E27	75	16001	Marge_FL65 E27	365	51396	Vision_2	385
12221	Oh!_PM3 E27	75	16105	Oh!_S65 LED	351	51585	Vision_1	385
						51586	Vision_1	385

Code	Product	Page	Code	Product	Page	Code	Product	Page
52700	Accessories	384	61290	Accessories	45	90347	Antigua_S	119
52901	Texo_RJ	384	61390N00	Gypsum_WF4	45	90348	Antigua_P	50
52951	Texo_QJ	384	61390W00	Gypsum_WF4	45	90349	Antigua_P	50
54284N00	Matrix-C30	304	62424	Electronics	34	99106	Electronics	33
54285N00	Matrix-C30	304	62431	Electronics	34			31
60680N70	Gypsum_WF3	45	62432	Electronics	34			33
60680W70	Gypsum_WF3	45	63820N00	Gypsum_QD2	35			34
60811N00	Gypsum_WR3	41	63820W00	Gypsum_QD2	35			35
60811W00	Gypsum_WR3	41	63830N00	Gypsum_QD1	34			36
60813N00	Gypsum_WR1	42	63830W00	Gypsum_QD1	34	99115	Electronics	39
60813W00	Gypsum_WR1	42	64180	Accessories	45			41
60814N00	Gypsum_WRQ	43	84647	Electronics	367			42
60814W00	Gypsum_WRQ	43	84893	Accessories	384			43
60815N00	Gypsum_WR2	42	84894	Accessories	384			44
60815W00	Gypsum_WR2	42			41	99126	Electronics	35
60817N00	Gypsum_W2 Bi Emission	171			42			31
60817W00	Gypsum_W2 Bi Emission	171	89144	Electronics	43			33
60819N00	Gypsum_W3 Bi Emission	171			44			34
60819W00	Gypsum_W3 Bi Emission	171			41	99147	Electronics	35
60824N45	Gypsum_03	33			42			36
60824W45	Gypsum_03	33	89145	Electronics	43			39
		31			44			31
		33	90206	Triad_W	231			33
		34	90207	Triad_W	231	99243	Electronics	34
		35	90208	Triad_S	231			35
		36	90209	Triad_S	231			39
60830	Accessories	37	90228	Triad_W	231			31
		41	90229	Triad_W	231			33
		42	90230	Triad_S	231			34
		43	90231	Triad_S	231			35
		44	90281	Crumb	151	99344	Electronics	39
		45	90282	Crumb	151			41
60834N00	Gypsum_W1 Mono Emission	171	90283	Horizon_S	175			42
60834W00	Gypsum_W1 Mono Emission	171	90284	Horizon_S	175			43
60836	Accessories	42	90285	Horizon_S	175			44
60837	Accessories	41	90286	Horizon_P	67	99345	Electronics	36
		43	90287	Horizon_P	67	CA001DBBMDI	Tara_Q	222
60838	Accessories	42	90288	Horizon_P	67	CA001DWHMDI	Tara_Q	222
		34	90296	Crumb	151	CA002DBBMDI	Tara_Q	223
		35	90297	Crumb	151	CA002DWHMDI	Tara_Q	223
60840	Accessories	36	90320	Metal	183	CA003DBBMDI	Tara_Q	223
		41	90322	Metal	183	CA003DWHMDI	Tara_Q	223
60860	Accessories	31	90324	Metal	183	CA004DBBMDI	Tara_R	222
60910N00	Gypsum_WRX	41	90332	Metal	183	CA004DWHMDI	Tara_R	222
60910W00	Gypsum_WRX	41	90333	Metal	183	CA005DBBMDI	Tara_R	223
60920N70	Gypsum_WF1	44	90334	Metal	183	CA005DWHMDI	Tara_R	223
60920W70	Gypsum_WF1	44	90335	Triad 2.0	229	CA006DBBMDI	Tara_R	223
60930N70	Gypsum_WF2	44	90336	Triad 2.0	229	CA006DWHMDI	Tara_R	223
60930W70	Gypsum_WF2	44	90337	Triad 2.0	229	CA007DBBMDI	Tara_B	225
61270	Accessories	44	90345	Antigua_S	119	CA007DWHMDI	Tara_B	225
61280	Accessories	44	90346	Antigua_S	119	CA008DBBMDI	Tara_B	225

# Code index

Code	Product	Page	Code	Product	Page	Code	Product	Page
CA008DWHMDI	Tara_B	225	KIT0098	Accessories	177	TR4114-4	Cable system accessories	316
CA009DDBMDI	Tara_B	225			276	TR4114-5	Cable system accessories	316
CA009DWHMDI	Tara_B	225	KIT0099	Accessories	177	TR4114-6	Cable system accessories	316
CA010DDBMDI	Tara Maxi	227			276	TR4117-4R	Cable system accessories	317
CA010DWHMDI	Tara Maxi	227	KIT0100	Sinfonia Sys. - Slave Canopy	285	TR4117-5	Cable system accessories	317
CA011DDBMDI	Tara Mega	227	KIT0101	Sinfonia Sys. - Slave Canopy	285	TR4117-6	Cable system accessories	317
CA011DWHMDI	Tara Mega	227	KIT0102	Sinfonia Sys. - Slave Canopy	285	TR4119-4	Cable system accessories	317
C-E700003	Electronics	367	KIT0104	Sinfonia Sys. - Slave Canopy	285	TR4119-5	Cable system accessories	317
C-W600001	Electronics	367	KIT0106	Sinfonia Sys. - Cable	285	TR4119-6	Cable system accessories	317
		381			199	TR4120-3	Cable system accessories	317
KIT0018	Electronics	383	KIT0107	Accessories	280	TR4124-4	Cable system accessories	319
		46			199	TR4124-5	Cable system accessories	319
		47	KIT0108	Accessories	280	TR4124-6	Cable system accessories	319
		65			285			317
		99	KIT0110	Accessories	285	TR4151-10	Cable system accessories	319
		111	KIT0112	Tu-O Black Cover	105			317
		123	KIT0113	Tu-O Black Cover	105	TR4151-20	Cable system accessories	319
		125			25			317
		133	KIT0114	Electronics	27			317
		135			381	TR4151-30	Cable system accessories	319
		136	KIT0116	Electronics	383			317
		138			59	TR4151-5	Cable system accessories	319
KIT0026	Accessories	138	KIT0120	Accessories	61			317
		139			59	TR4151-50	Cable system accessories	319
		142	KIT0121	Accessories	61			317
		143			215	TR4153-10	Cable system accessories	319
		194	KIT72	Electronics	217			317
		195			215	TR4153-20	Cable system accessories	319
		222	KIT73	Electronics	217			317
		223			381	TR4153-30	Cable system accessories	319
		225	KIT77	Accessories	383			317
		227			361	TR4153-5	Cable system accessories	319
		235	KIT9095	Accessories	361			317
			TR4000-4	Vega-C30_1	315	TR4153-50	Cable system accessories	319
			TR4000-5	Vega-C30_1	315			294
KIT0028	Accessories	125	TR4014-4	Vega-C30_2	315	TR4304-4R	Andromeda-C_1	294
KIT0029	Accessories	125	TR4014-5	Vega-C30_2	315	TR4304-5	Andromeda-C_1	294
KIT0064	Electronics	46	TR4101-4	Cable system accessories	318	TR4304-6	Andromeda-C_1	294
		47	TR4101-5	Cable system accessories	318			
KIT0065	Electronics	46	TR4101-6	Cable system accessories	318			
		47	TR4103-4	Cable system accessories	319			
		325	TR4103-5	Cable system accessories	319			
KIT0066	Electronics	351	TR4103-6	Cable system accessories	319			
		369	TR4104-3	Cable system accessories	319			
KIT0083	Accessories	359	TR4105-4R	Cable system accessories	319			
KIT0090	Sinfonia Sys. - Master Canopy	285	TR4105-5	Cable system accessories	319			
KIT0091	Sinfonia Sys. - Master Canopy	285	TR4105-6	Cable system accessories	319			
KIT0092	Sinfonia Sys. - Master Canopy	285	TR4109-4	Cable system accessories	318			
KIT0094	Sinfonia Sys. - Master Canopy	285	TR4109-5	Cable system accessories	318			
		177	TR4109-6	Cable system accessories	318			
KIT0096	Accessories	276	TR4111-4	Cable system accessories	316			
		25	TR4111-5	Cable system accessories	316			
KIT0097	Electronics	27	TR4111-6	Cable system accessories	316			

# How to read catalogue

Nome prodotto  
Product name

Potenza  
Power

Tipo di LED  
LED type

Caratteristiche elettronica  
Electronics characteristic

Product	Cct	Cri	lm S	lm D	Optics
8275	3000	80	1628	1200	Diffused
8276					
8277					

Im S  
Lumen Source

Im D  
Lumen Delivery

Crew\_1 | 220-240 V | topLED 11 W DC - 12 W AC



Pittogrammi - "How to read symbols" vedi pagina 386  
Pictograms - "How to read symbols" see page 386

Nome famiglia  
Family name

Descrizione prodotto  
Product description

Posizione altri prodotti della stessa famiglia  
Page reference to other products in the same family

Immagine del prodotto con relativo disegno tecnico.  
Image of the product with relative technical dimension drawing



## Finishes

White    Dark Grey    Burnished    Legenda

Plus prodotto  
Product benefits





# Addresses

## Linea Light HQ Italy

via della Fornace, 59 z.i.  
31023 Castelmio di Resana (TV) - Italy  
Phone: +39 0423 7868  
Fax: +39 0423 786900  
info@linealight.com

## Linea Light Milano

via Morimondo, 26 int. 17G  
20143 Milano - Italy  
Phone: +39 02 36750915  
Fax: +39 02 36750915  
milano@linealight.com

## Linea Light Roma

Via La Spezia, 34  
00182 Roma - Italy  
Phone: +39 06 68589134  
info@linealightroma.com

## Linea Light UK

Suite 109 - The Business Design Centre  
52 Upper Street - Islington N10QH  
London - UK  
Phone: +44 0203 6371983  
info@linealight-uk.com

## Linea Light France

Z.A. Heiden Est, 12 rue des Pays-Bas  
68310 Wittelsheim - France  
Phone: +33 389 75 52 23  
Fax: +33 389 75 59 07  
info@linealight.fr

## Linea Light Deutschland

Aktienstraße 214  
45473 Mülheim Ruhr - Germany  
Phone: +49 208 299979-0  
Fax: +49 208 299979-10  
service@linealight.de

## Linea Light Spain

C/ Longares, 48  
28022 Madrid - Spain  
Phone: +34 912534773  
gestion@linealight.com

## Linea Light USA - Inter Lux

3741 Commerce Drive  
Suites 306-308  
Baltimore, MD 21227 - USA  
Phone: +1 410 381 1497  
Fax: +1 410 381 1589  
answers@inter-lux.com

## Linea Light Asia - Pacific

No. 7, Nanyi Huayuan Road, Industry Avenue,  
528478 Xiaolan Town, Zhongshan City,  
Guangdong Province - China  
Phone: +86 760 87618355  
info@linealight.com.cn

## Linea Light Singapore

21 Kaki Bukit Place, 5th Fl.  
Eunos Techpark Singapore  
416199 Singapore  
Phone: +65-6908 5758  
info.sg@linealight.com

## Linea Light GCC

Jumeirah Lake Towers  
JBC2 - 35th Floor Cluster V - Dubai - UAE  
P.O. Box 125902  
Phone: +971 4 4218275  
Fax: +971 4 4218274  
info@linealight.ae

## Printed in Italy

March 2023  
Rev.00

## Press

Imoco S.p.A.

## Special thanks to

Nerokubo  
Quasarfoto  
Costa Architetti, Ph. Studio Mörf / Ui - Sicilian food experience, Catania  
Riccardo Palmieri Architetto, COEN srl / Private Villa, Poggio Rusco (MN - IT)  
Yannis Kontos Photojournalists and IFI Group / Sirene Beach Hotel (Rhodes - GR)  
Silvia Spina Architetto, Inclined 2 Photography - Giorgio Bottitta / House SGC, Aci Sant'Antonio (CT - IT)  
Arch. Paolo Didonè, Arch. Devvy Comacchio, Ph. Kassel + Wassel / House DG, Rossano Veneto (VI - IT)  
Studio Architetti Associati Giampietro & Stefano Cinel, Ph. The Studio / Residence Civico 3.9, Castelfranco Veneto (TV - IT)  
RSG Group (Samuele Frosio, Tilman Schmidt, Konstantina Gkovari), Cristiandeklic Photography / John Reed Fitness Music Club, Trieste  
Arch. Giorgio Colombo - Light+Arch Consultancy, R4M Engineering / Aria Retreat & SPA, Porlezza (CO - IT)  
Elena Prosdocimo, Paolo Falasca / Hotel Ristorante Fior, Castelfranco Veneto (TV - IT)  
FPAA Studio - Arch. Alessia Fiori, Arch. Giacomo Pietrapiana / Private garden, Monte Argentario (GR - IT)  
Studio Christian Grande, Ph. Marco Reggi / Membership Private Club, Milano  
Arch. Gianluca Gentili, Ph. Matteo Canestraro / Ristorante Prati Rione Gastronomico, Roma  
DomECO, Ph. Studio Vetroblu / House AF, Alghero (SS - IT)  
Oscar Abril Revuelta, Ph. Marek Jarosz / Private Villa, Madrid  
Valentini Interiors Snc and Valentini Srl, Cadoneghe (PD - IT)  
Shine Residence, Jesolo (VE - IT)

**linealight.com**





Cover printed on Fedrigoni Symbol Card paper



Cert no. CQ-COC-000010  
© 1996 Forest Stewardship Council

ELEMENTAL  
CHLORINE  
FREE  
GUARANTEED



Inside pages printed on Sappi Magno Satin paper



Type of printing



Printed with Saphira Eco

**HEIDELBERG**





**LIGHT UP NEW IDEAS!**

[linealight.com](http://linealight.com)